

# Yuánes 14



«Mitédúgá mí nda beeg búbulə bī mílúúd. Búgúlágá Zembī, bī \*búgula mə. Njów mé Dā wúse nə zhwog ikúl búúd bī nə ηkul ji yí. Í mbēm bə kú bə ntó, ηki mə mé námé jaaw bī. Mə zé kə kwambulə bī jiya. Ja mé bá shīn kwambulə bī jiya yí, mə bá nyiηgə zə ηwa bī, kə nə bī. Mə bá kə nə bī né bī bág námé bə kúl mé jisé yí.»



Mə \*mínyoηê wún Yuánes, mə muud shé ηgə bwəma nə məntágula məmpwūd, shé tél cé íci ηgwūd, shé nə zény ηgwūd kélé shwóg nə Yésus

yé, bwé á kənd mə míkwám dī ηkwamé bwé jów né



Patmos yí. Í á bə necé Milésú mí Zembī, nə mə wále cug jām né mə ηgə bwiηg lánj mé Yésus.

Kú námé bwey, Ɔkɛ̀ɛkɛ̀ Shíshim mú zə sá mə nda mə ɲgə cɛgə ɲi \*shíshim ɔ́. Mə mú sɛ dúg məma \*caangé, muud ɲjúl cínɔŋg.

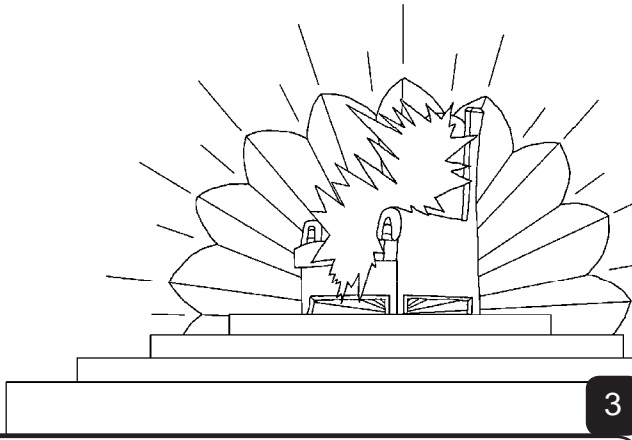

3

Mə mú gwág íkukwumɛga byêsh Zembî nyə a sá tɔɔ jon ɔ́ gwôw, tɔɔ wa shí, tɔɔ shí ga ɔ́ shí, tɔɔ m̃ɲ yí, nə isâ byêsh bísé cínɔŋg yí, byêsh í ɲgə ci né: Nyɔɔŋg ɲjúl caangéd yé bá Mwâ nɔwɛmɛ, bwé m̃píyá nə məzhwámá, nə gúmé, nə milwané, nə ɲkul kandugə á kandugə.

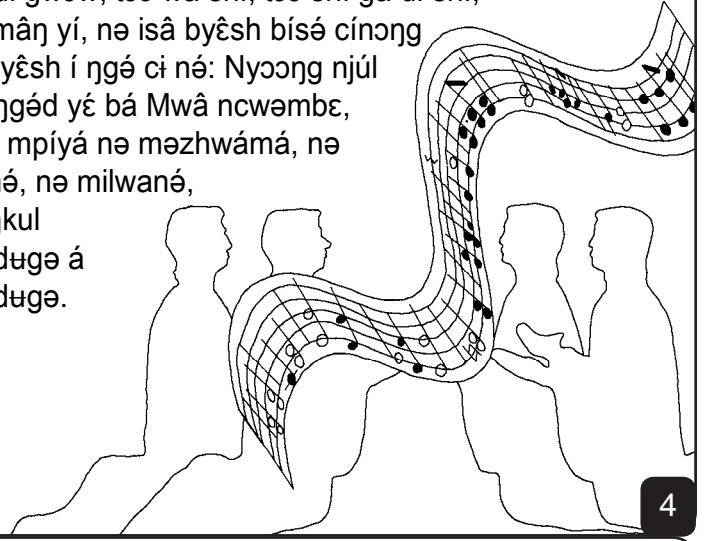

4

Mə mú dúg Yurúsalem agúgwáan, ɲkɛ̀ɛkɛ̀ ɲgwéla ɲgə shulə wú gwôw wé Zembî. Í á bə í mé shîn cwɔ nyúul nda mudá mé kwísha né a ké béya yé. Mə mú gwág dúl kél í ɲgə wú \*caangé mé Zembî ɔ́, í ɲgə ci nə ɲkulú né:

«Zembî bɛ́nɔŋ buud banda dán wéga. Zembî mə zé ji búúd ɔ́, buud bwé mú sɛ bə búúd bé, nyɛ ntág Zembî wán.»

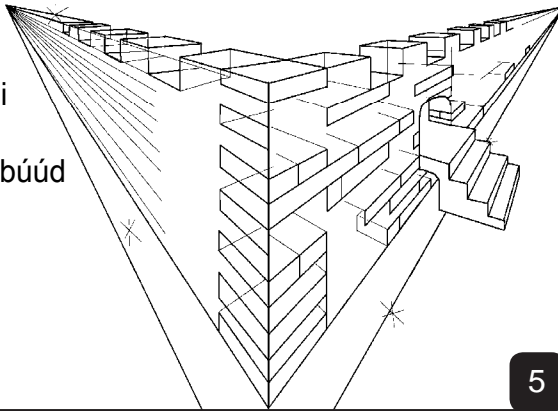

5

Né ndéé, \*ɛŋgales éne mú lwó mə ɲgwɔ́ m̃ájúwó mé cɛg, í ɲjúl né ɲkúl-ɲkúl nda yê kristâl; ɲgwɔ́ wɔɔŋg í ɲgə zhu \*caangé mé Zembî bá Mwâ Nɔwɛmɛ ɔ́, í ɲgə wô t̃am ɲgwéla, ɼ cɛg í t̃él m̃enciindyé mé ɲgwɔ́ m̃əbá m̃êsh ɔ́.

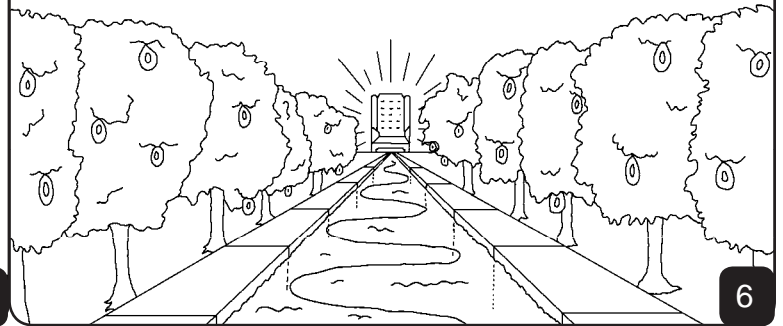

6

Ɔgwéla wɔɔŋg í áŋgɛ nə ji jwôw, kú ji ɲkwoond; milwané mí Zembî wé mí ɲgə kwan wə, Mwâ Nɔwɛmɛ jisə mɔɔs í ɲgə kwan ɲgwéla wɔɔŋg yí.

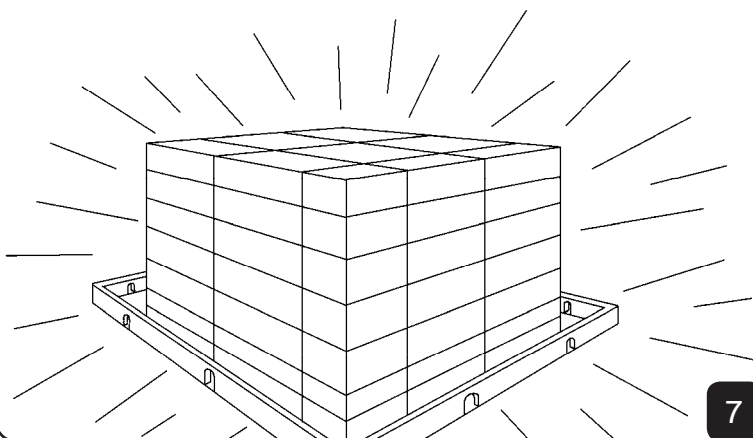

7

Sâ j̃ ɲkí dana mísh mé Zembî ɔ́ yí í ábúlé bwɛle kə cínɔŋg, tɛɛm bə múúd nyə a mé wusə nyúúl isâ í áduɔdanâ ɔ́ nə íjɔ́ ɔ́ yé. Buud bwé bá kə cínɔŋgú ɲi bɔɔŋg m̃íné m̃ánj m̃ésé cilyá kálaad á cɛg mə Mwâ Nɔwɛmɛ ɔ́ wá.

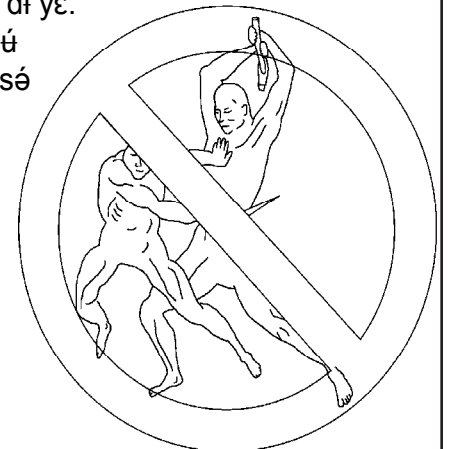

8

«A bá cind bwo məzhwíle mēsh, bwé ábúlé ná bwele dɛ yə, bwé kú ná bwele dɛ sá məshwi, kú ná bwele jug nɛ məɛy. Isá í acwúlú í á mé cɔ.»



9

Sá í ábúlé ná nyingə bwəma nɛ məlweemyá ηgwéla wəɔηgúd. Caηgə mə Zembî bá Mwâ Ncwəmbɛ í bá bɛ wu. Osól ó mészál ó Zembî bwé bá sá Zembî iséy. Bwé bá dɔg mpwóombú nyé, bwé bɛ námé nɛ jíné dé cilyá məmpwoombúd.



10

Mə mú dɔg búúd bwé á yə wá, tɔɔ ozhizhe ɔ búúd, tɔɔ fwámé búúd, bwé tél otútəlí mpwóombú caηgəd. Okálaad bwé músə bɛnyɔw. Mpúsə búni, bwé mú nyingə bɛny ηgwólúgá íshús, nyāη njúl kálaad á cɔg. Zembî mú ηgə sámb buud bwé á yə wá milésú, ηgə bɛ mísólúgú myāη. Muud yēsh jíné í á bɛ kú nyín kálaad á cɔg dī yé nyə á wusɔw bī kudad.

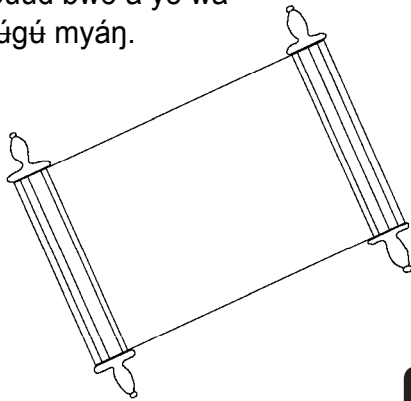

11

Ŋkɛŋkɛ Shishim bá ηgwɔɔl mə Mwâ Ncwəmbɛ bwé ηgə cɪ né: «Zaág!» Muud yēsh ηgə gwág yé cīg nɛ: «Zaág!» Muud ηgə gwág shwáásúlə minú yé zég. Muud mə jī məjúwó mé cɔg yé, légúg mwo ashwá!



12

Nécé, Zembî nyə á cɛel buud ɔ shí ga nɛ mbiya yáág-yáág cɛelí, váál á né, nyə a yána Cúgə lú Mwán dé né muud yēsh mə búgula nyə yé bág bɛ kú yə, a yidag bɛ nɛ cɔg á kandugə kandugə.

13

Buud ó Róma 3:23  
nécé buud bēsh bwé á mé sēm, né ndéé milwané mí Zembî mí á mé wú bwédí ícugud.

Buud ó Róma 6:23  
Haaw, sém í kwaamb múúd shwi, nji Zembî nywáá mə yé múúd cɔg á kandugə kandugə mpáam nyéd; a yáná gwo kwoη mə Cwámba wúsú \*Kříst Yésus dī.

Wəheburə 9:27  
Ŋkúmba cígúlá wúsə né muud mé jəlá nɛ yə nji ja ηgwúd né ndéé a mú bá kə tšw kɔɔdɛd.

14

Buud ó Ifêz 2:8,9

Mpugá né mpaam mé Zembî wé í á mé sá né bi dúgúg cug, bi a mé ka ntâg bii mpaam nyɔɔŋgú nɛ zhĩ a búgú. Sólúgú wɔɔŋg í cúgɛ sólúgú wún, jísɛ yána mé Zembî. Shé ádugeé cug nɛcɛ fwǒlɛ sá wúl sólúgú, mbô. Muud nda jee ñkêny nyúul.

Buud ó Róma 10:9,10

Ji né, wó ká lás nɛ mpu wô né Yésus ji Cwám̄ba, wo búgula nɛ lâm wô né Zembî nyɛ a gwúmushi nyɛ, wo dúg cug. Ji ntó. Muud mé du búgula nɛ lâm, Zembî mú ci né a ji títɛlí muud; muud lás nɛ mpu, Zembî mú yɛ nyɛ cug.

15

Yuánes 3:16,17

Nɛcɛ, Zembî nyɛ á cɛɛl buud ɔ shí ga nɛ mbiya yáág-yáág cɛɛlí, váál á né, nyɛ a yána Cúgú lú Mwán dé né muud yêsh mɛ búgula nyɛ yé bág bɛ kú yɛ, a yidag bɛ nɛ cug á kandugɛ kandugɛ. Mpugá né Zembî nyɛ a shígɛ ntɛ Mwán yé shí ga dí né a zég yɛ búud intúgúlí, i á yida bɛ né a zég sá né buud bwé fáámɛg.

1 Yuánes 5:11-13

Bwaagulélɛ wɔɔŋg wí nɛéé: «Zembî nyɛ a mé yɛ shé cug á kandugɛ kandugɛ; cug jɔɔŋg í ñgɛ zhu wé Mwán yé. Muud ji nɛ Mwán mɛ Zembî yé ji nɛ cug; muud cúgɛ nɛ Mwán mé Zembî yé cugɛ nɛ cug.» Mé cilɛ bí isâ íni, bi mpúg né bi mú nɛ cug á kandugɛ kandugɛ, bí buud ñgɛ \*búgula jínɛ mé \*Mwán mé Zembî wá.

16

Yuánes 14; 2 Buud ó Kɔrɛnt 5; Mbúgúlu 4, 21, 22

Storyline by: Edward D. Hughes

Illustrated by: Lazarus  
and Alastair Paterson

Adapted by: Sarah S.

Makaa NT (mcp) © 2014, Wycliffe Bible Translators, Inc.  
All rights reserved.

<https://live.bible.is/bible/MCPWBT/MAT/1>

©2026 Bible for Children, Inc.  
www.M1914.org www.bibleforchildren.org

17

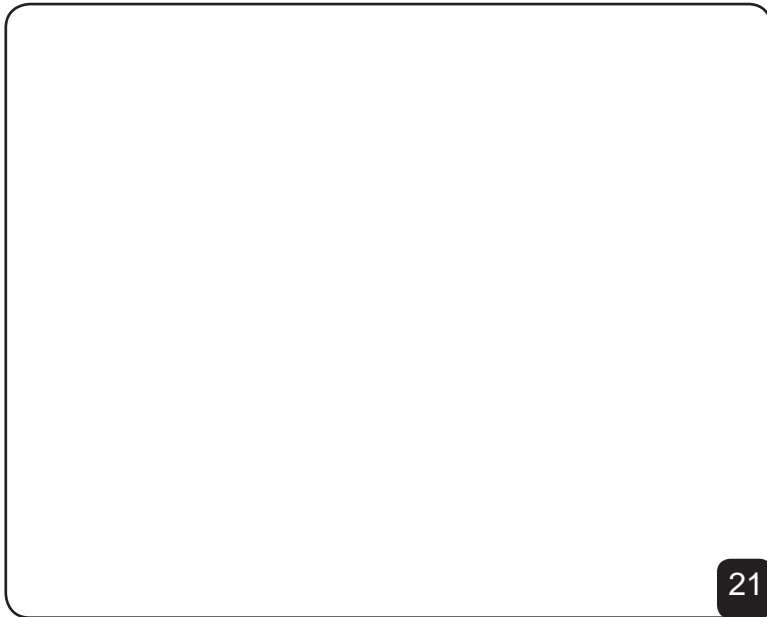

21

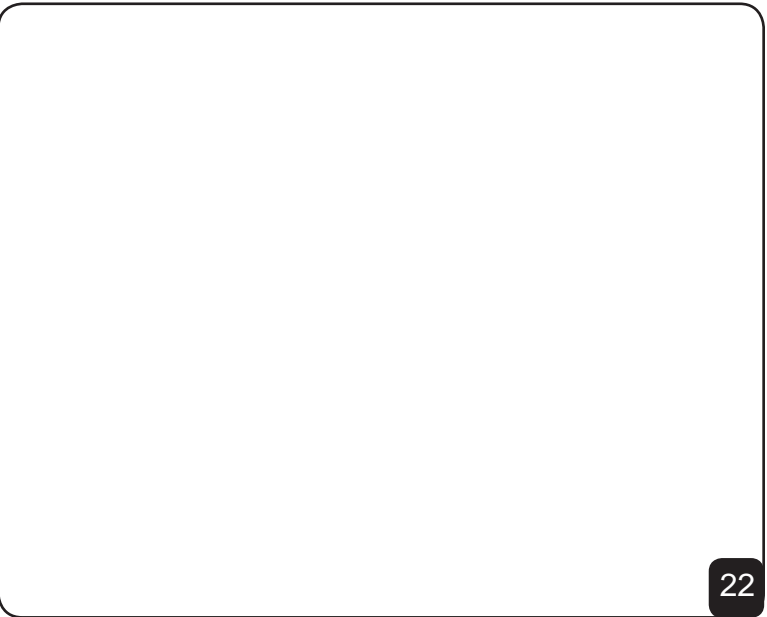

22

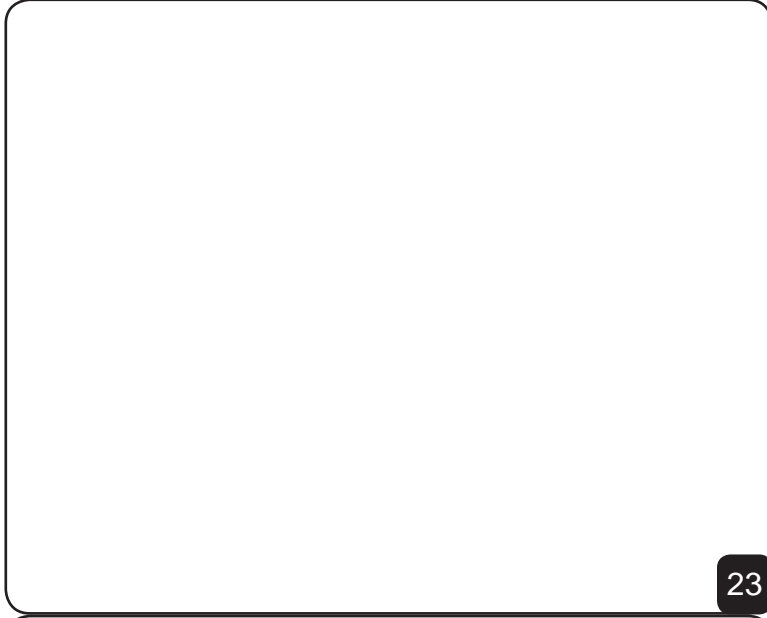

23



24



25



26

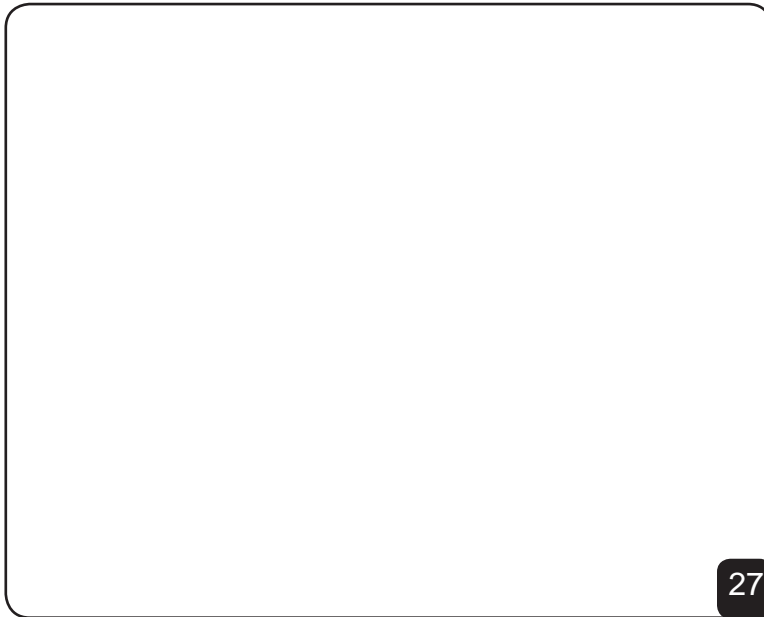

27

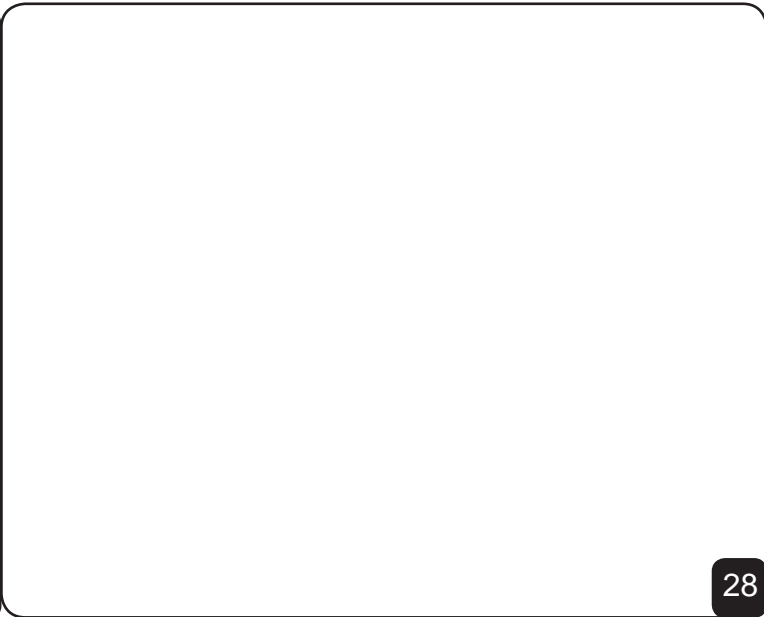

28

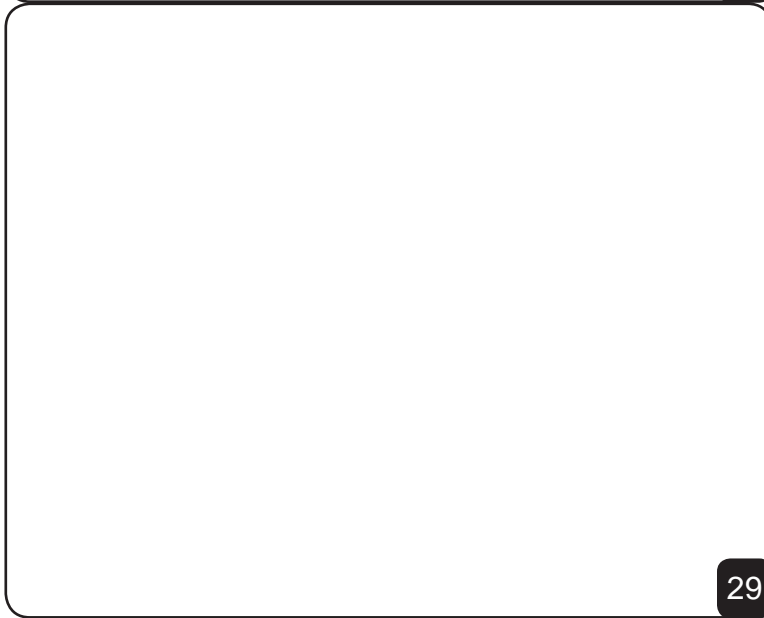

29

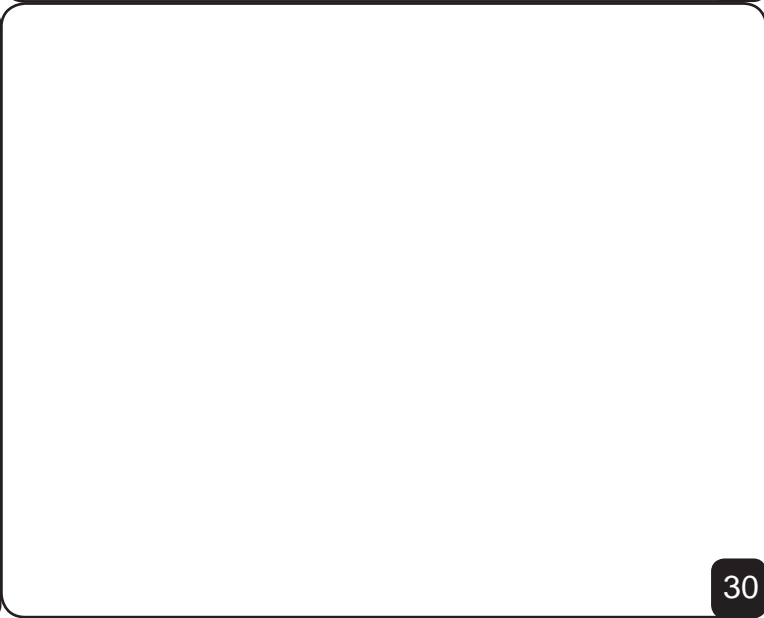

30

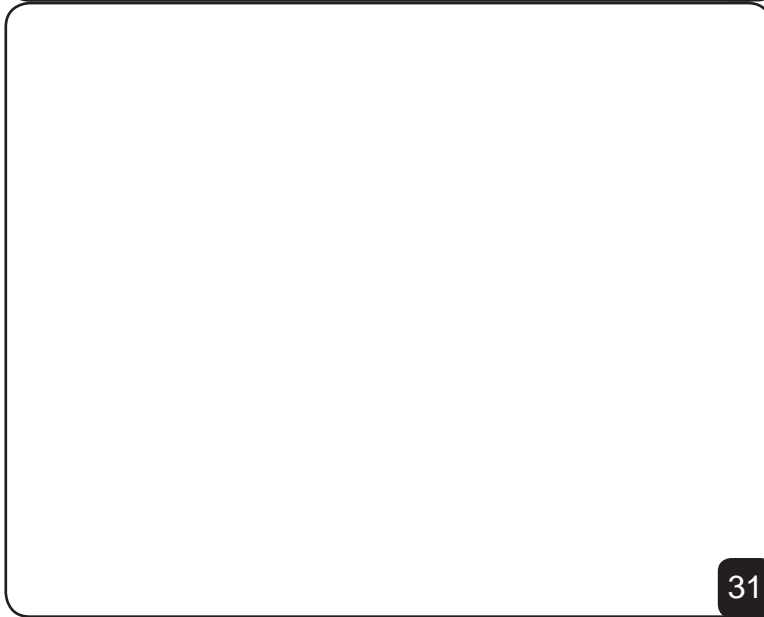

31

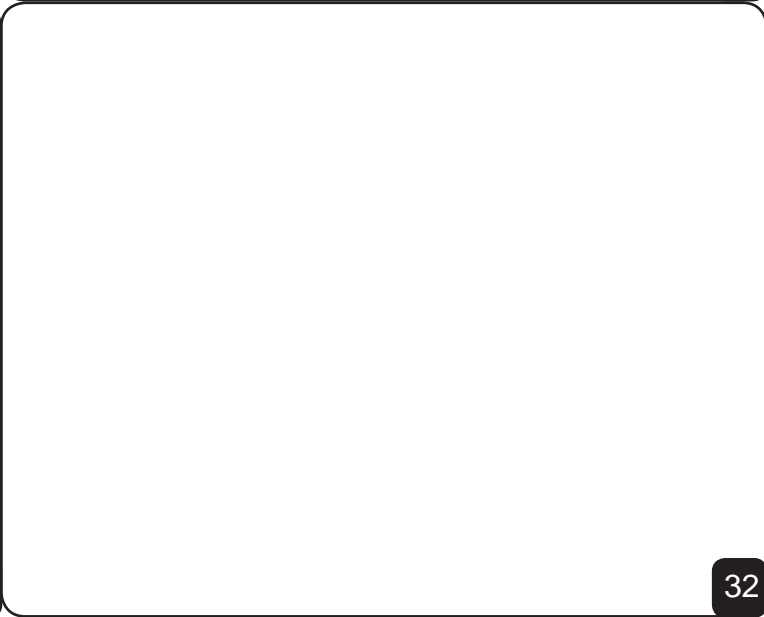

32

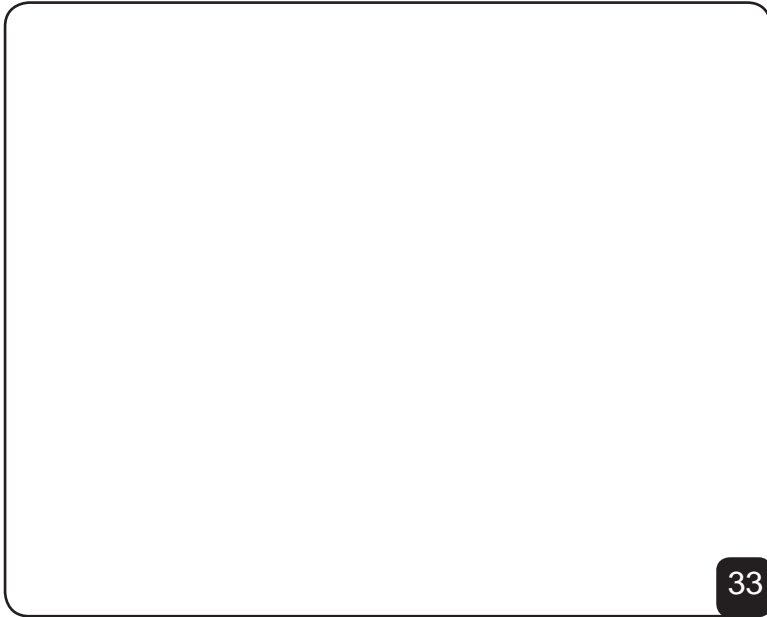

33

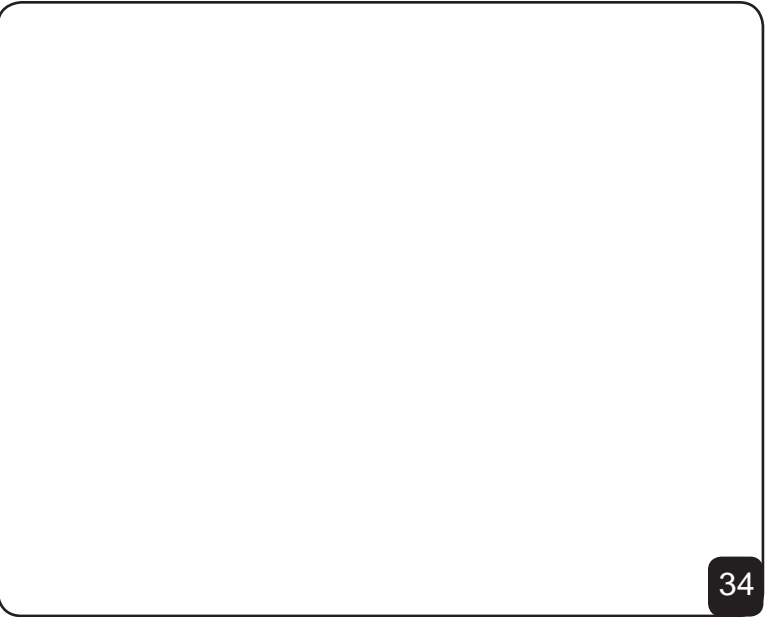

34



35



36

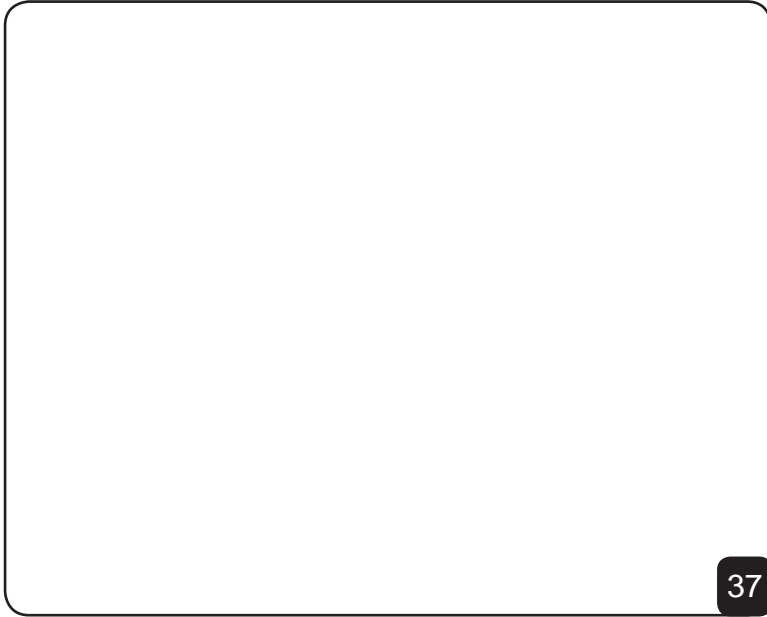

37



38

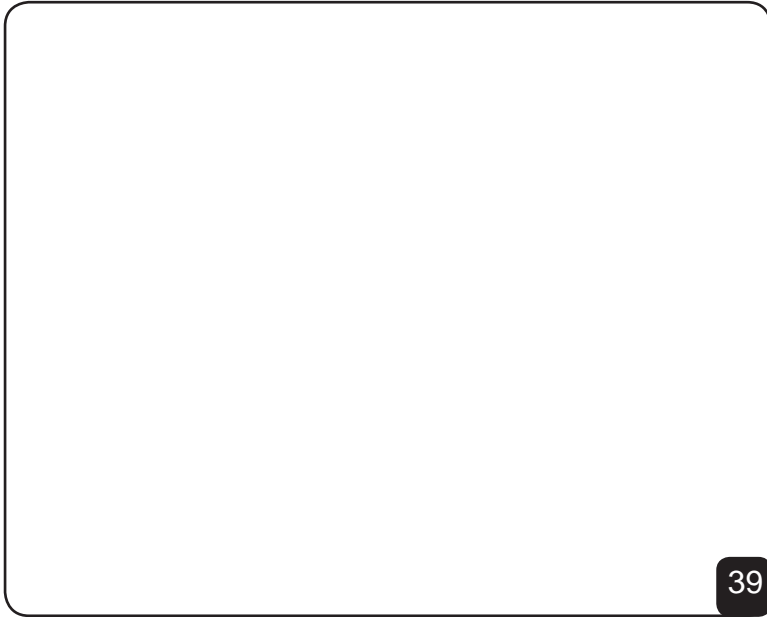

39

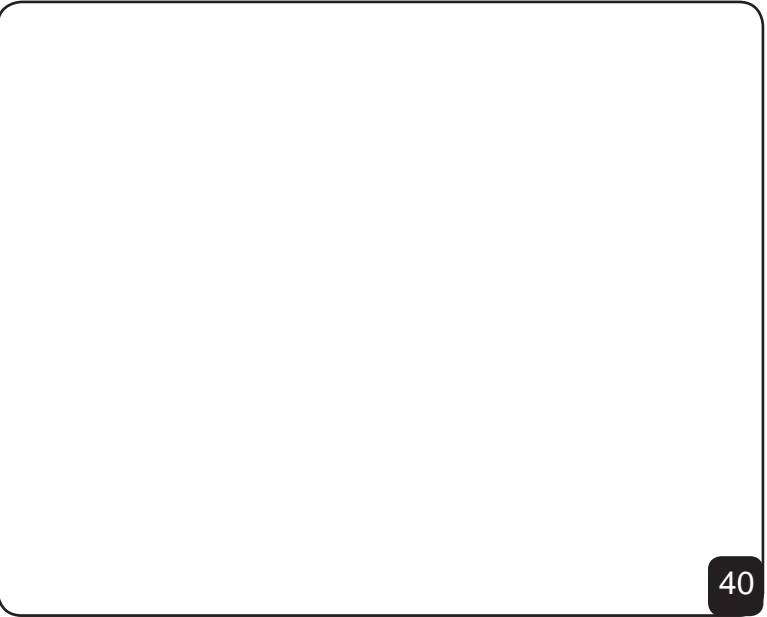

40

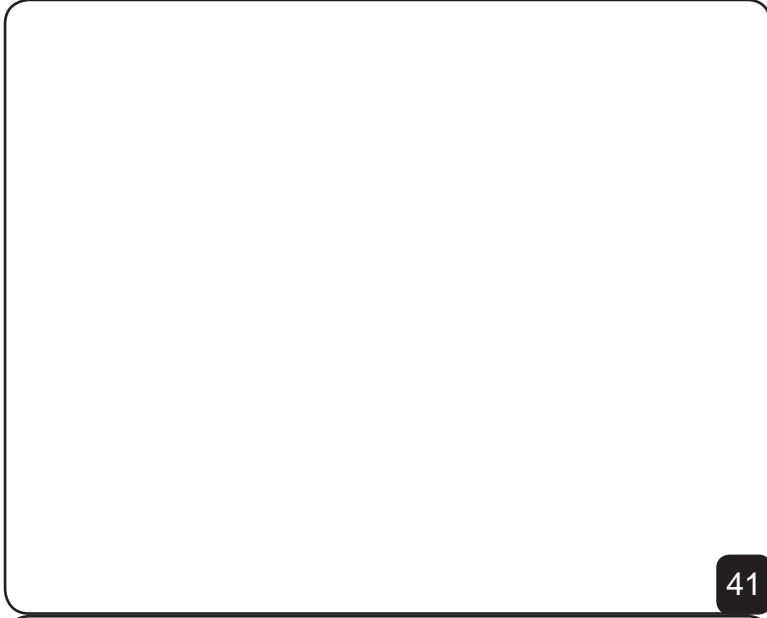

41



42



43



44

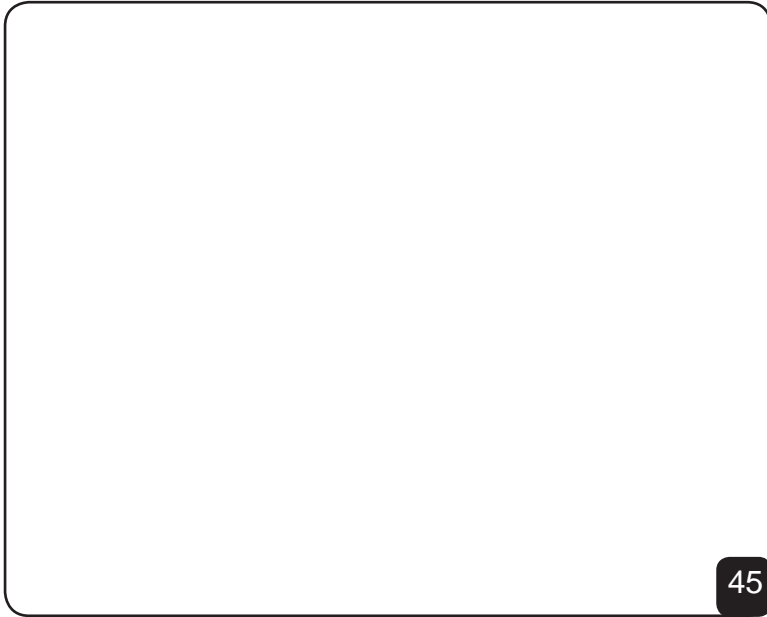

45

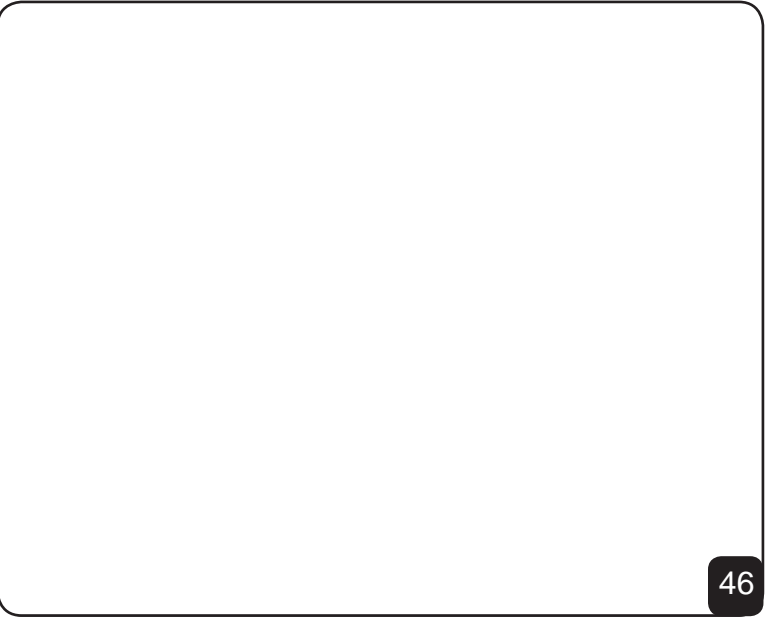

46

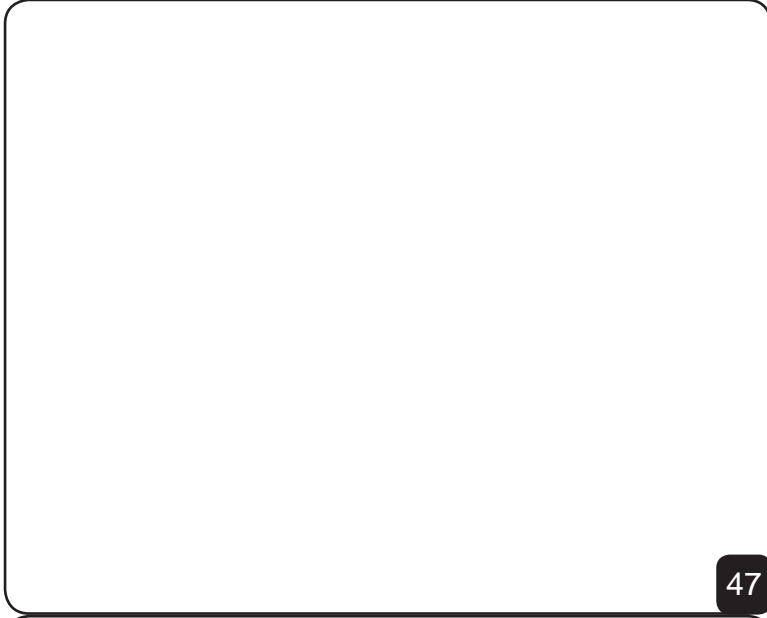

47

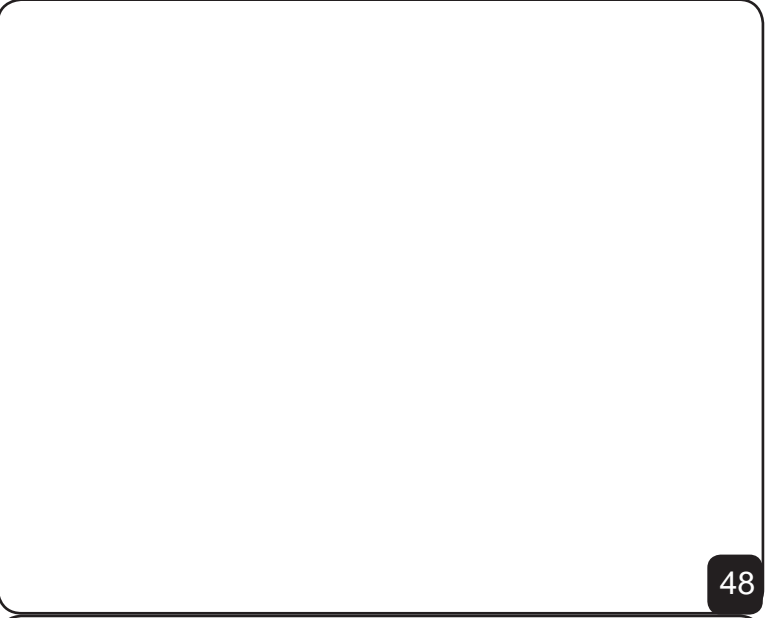

48

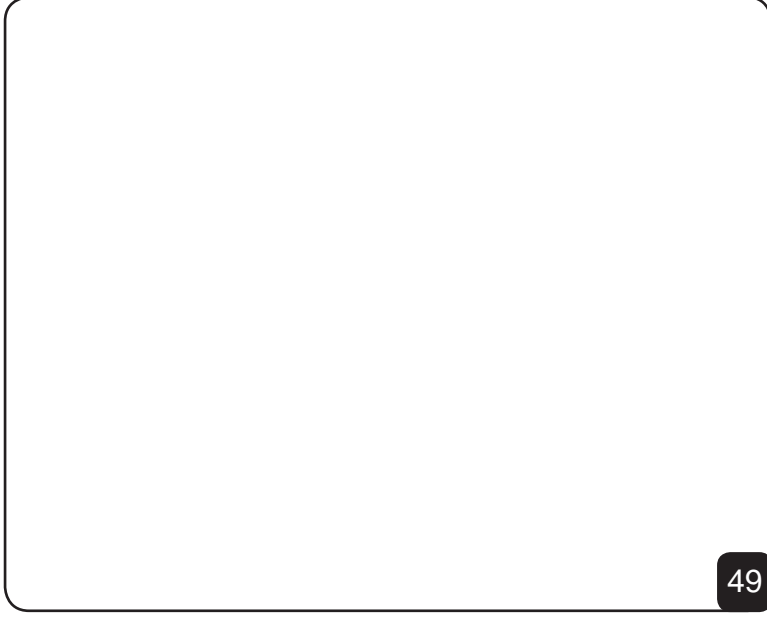

49



50

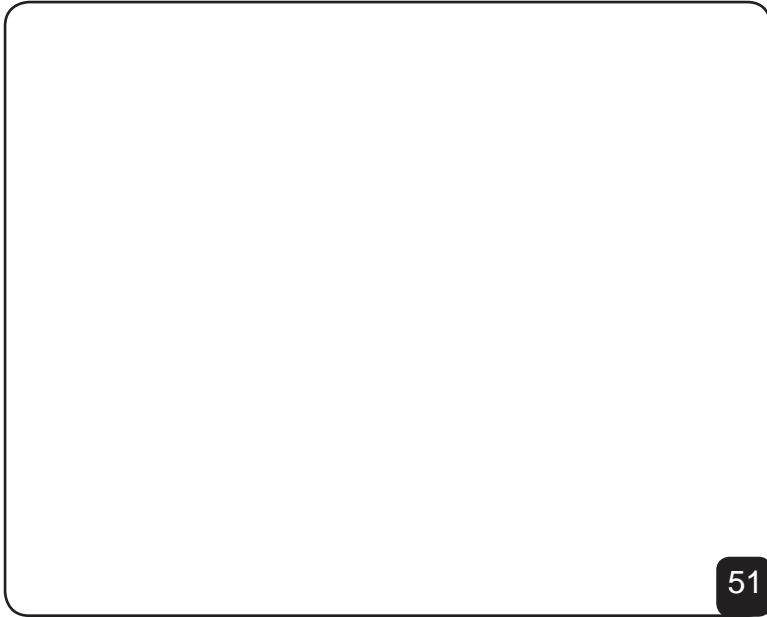

51

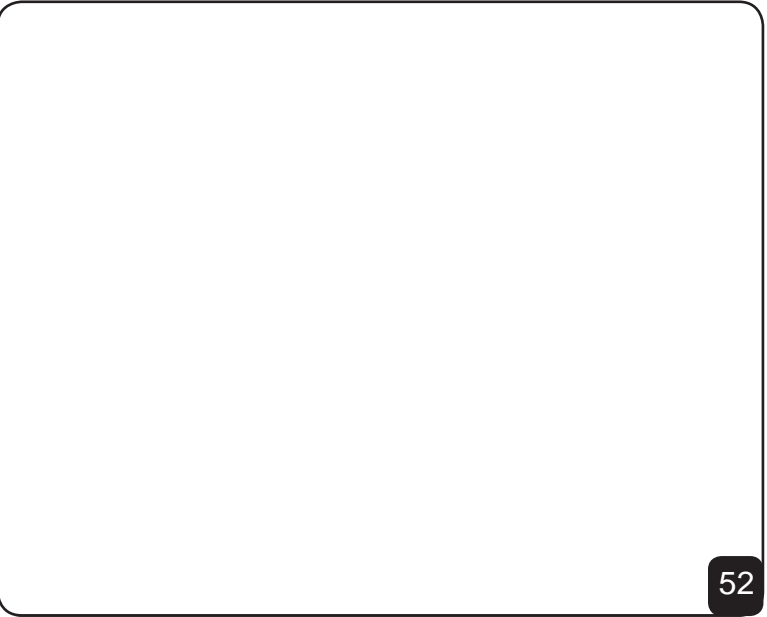

52

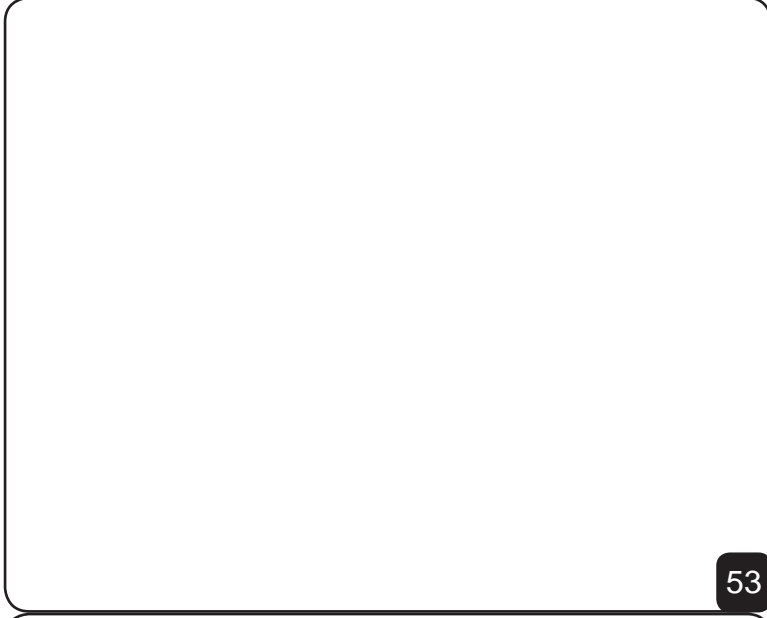

53

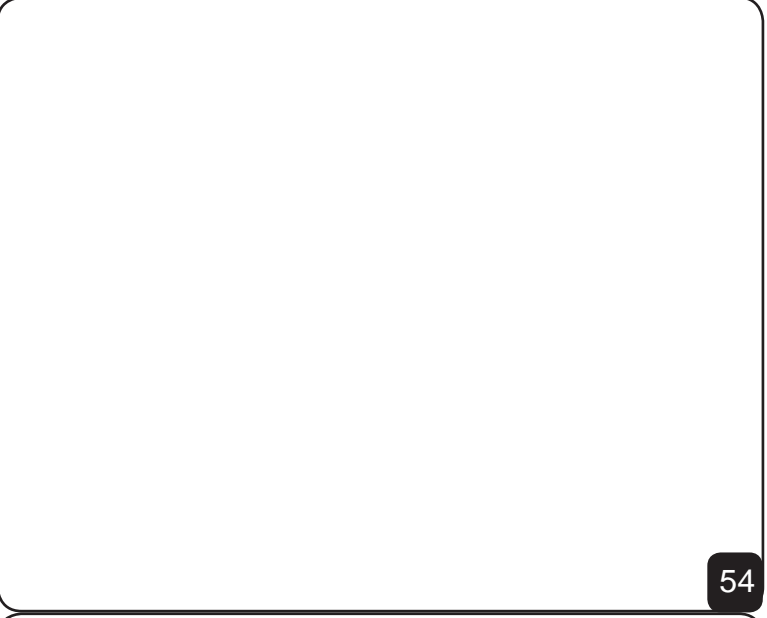

54

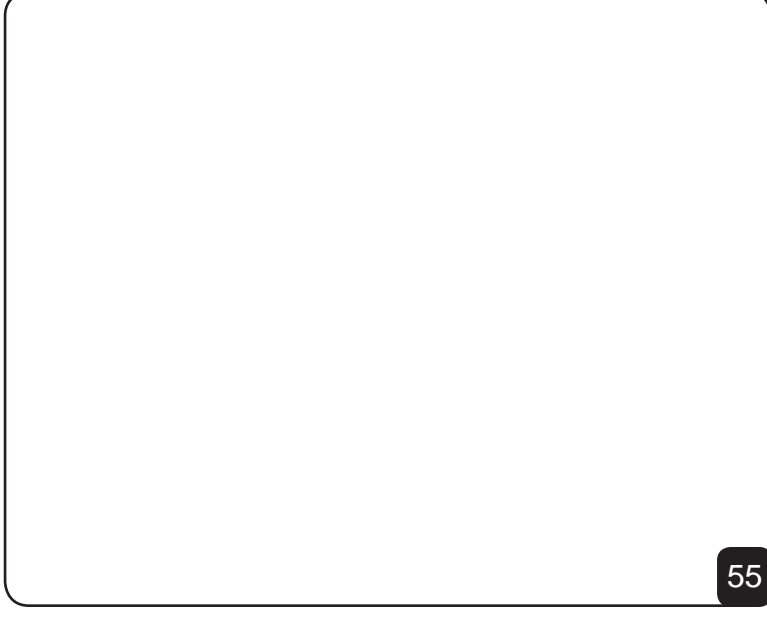

55

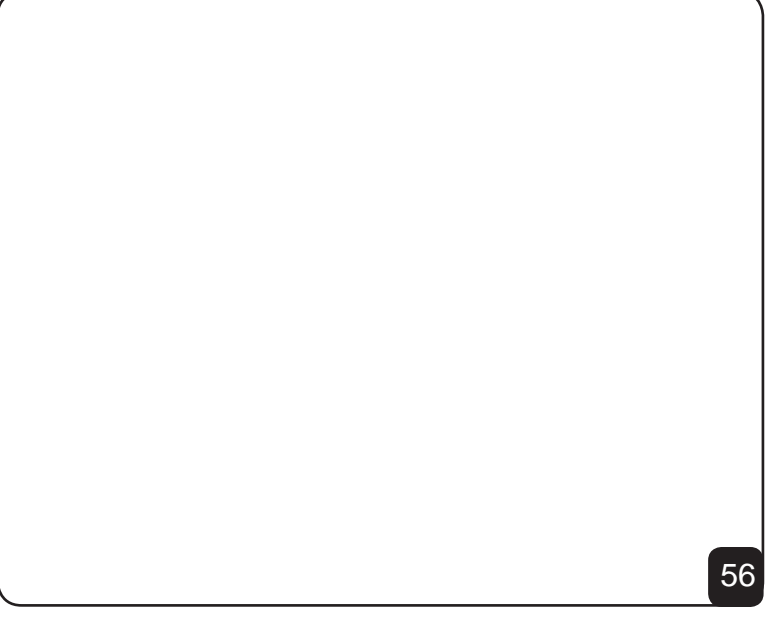

56



57



58

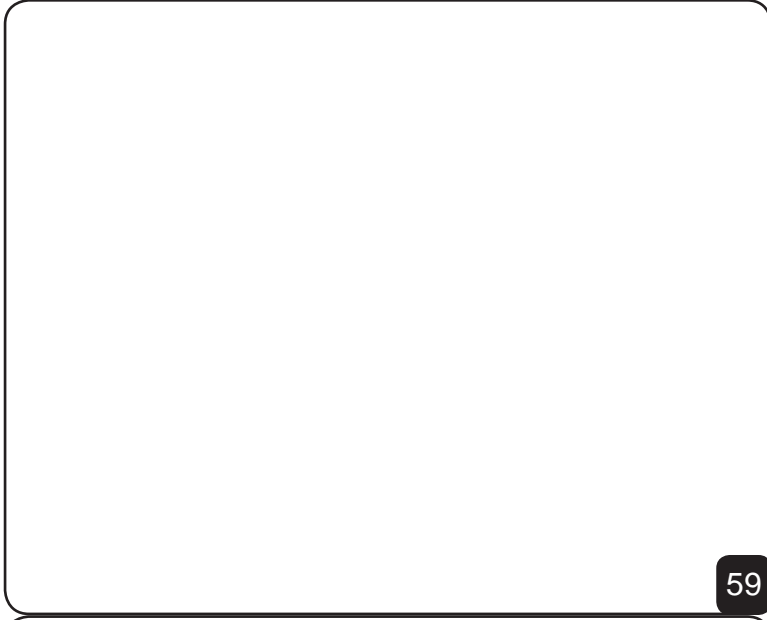

59

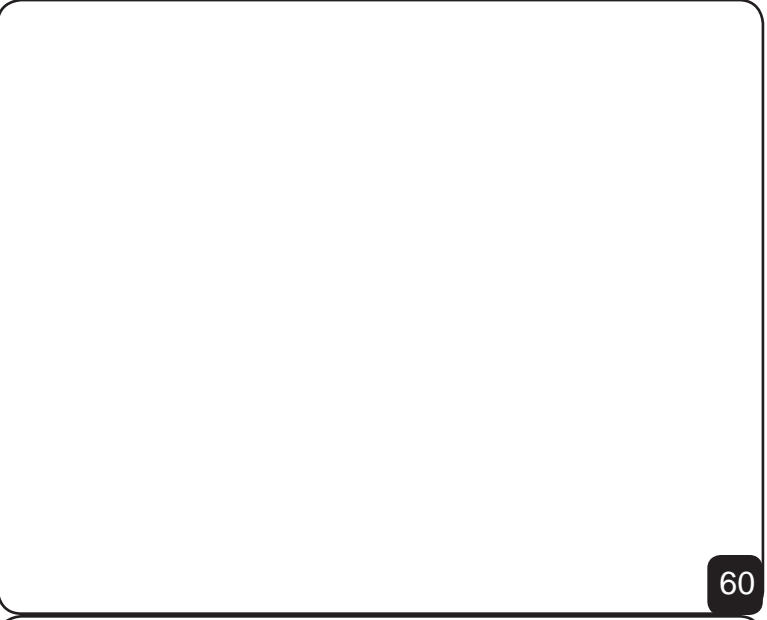

60



61



62