

Wainlalangare ole erere
Rurumong ake nge a Jona na silang aolonga

Rurumong ake nge
a Jonan na silang
aolonga



Ako Edward Hughes i wat i
Ako Jonathan Hay i wat a seire
Ako Mary-Anne S. i pakomkmoes i
Ako Hobson Mimi i eksing i
Wainlalangare ole erere ake
Bible for children i pavelpol i
www.M1914.org

BFC
PO Box 3
Winnipeg, MB R3C 2G1
Canada

©2024 Bible for Children, Inc.

I sivenga ako aro ong printim Rurumong ake na sung polpol i a
tokokoere nge. Ave mothong tova ong el umtun eve ur pelie nge
Rurumong ake omanga eve salimnga.



Nomenga ako a Israel, toko ako
iion a Jona i voth nge, lama nge
nang omole ako Patenger i pake i
a rempomnga ako
iion a Ninive.

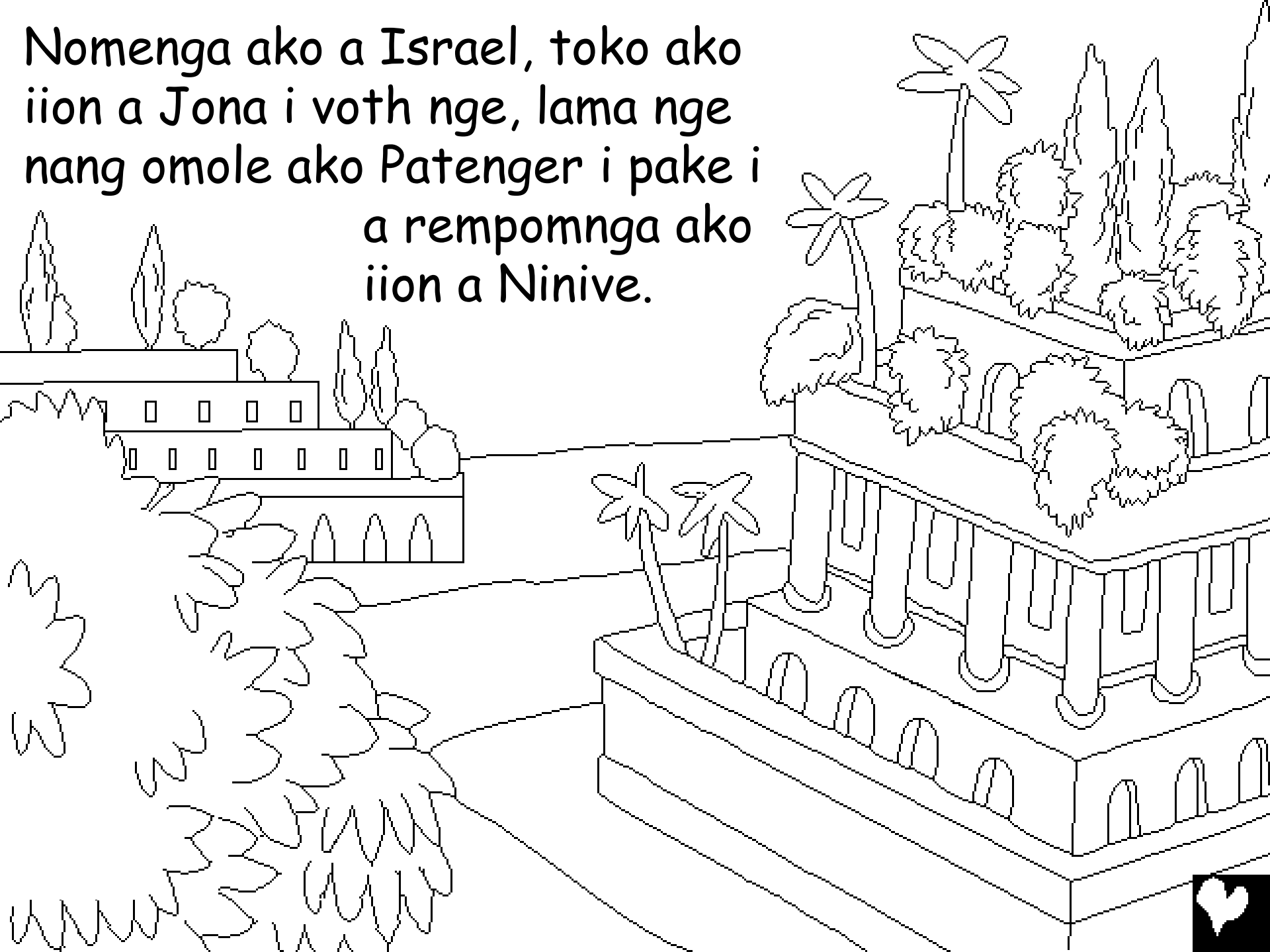

Na rempomnga aken i mukal nge
rempomnga alavusnga nge wop lemi
aken. Na Patenger i sis ve aro
Jona i es mo i panongpol na i
panakal toko na sengre nge
a Patenger ile riong eneke,
ole vothung kerenga
kene i aolotun lale
ako Patenger kene
ilemi mire nge ole
vothung areken lale.



Aveto Jona i avsa a
Patenger ile riong ma i
roa nge imot ma i lo sele
a Tarsis la, na i es ol a
Ninive avele.

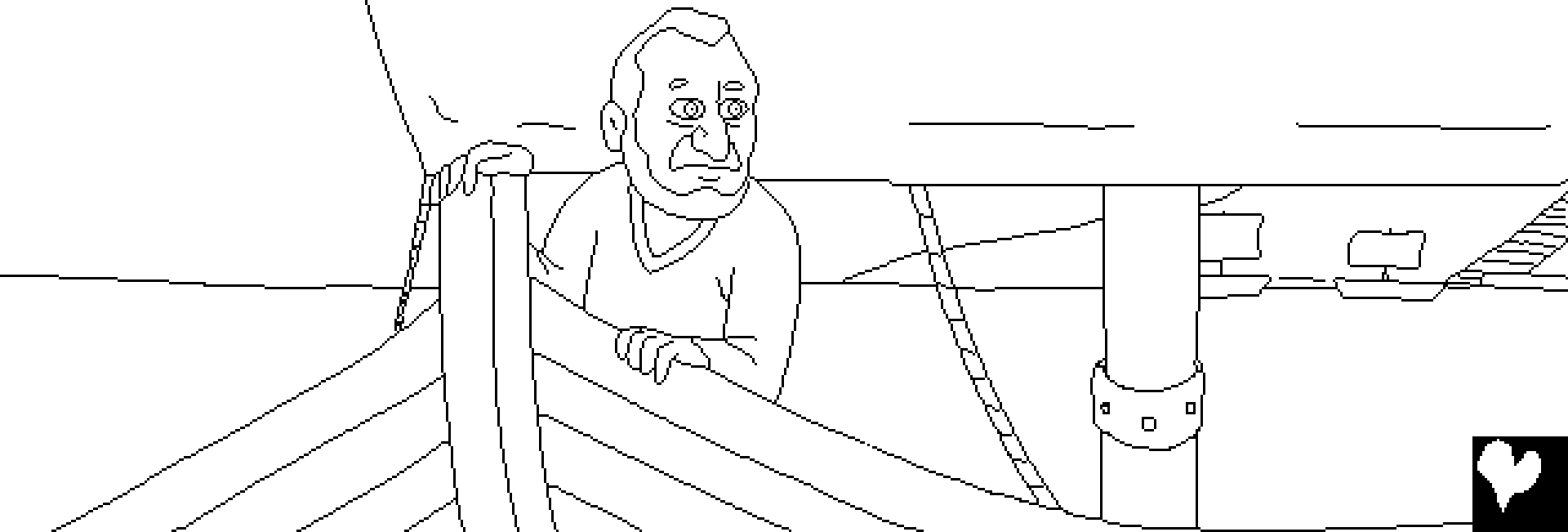

Mako Toko Pomnga i pake thue ome vit aolonga a
thev stha la, ma thev ile punong i aolonga rintet,
mako imot aken a umongare o ngeip ritet, ako o ri
tovanga aro imot aken aro i vlu.

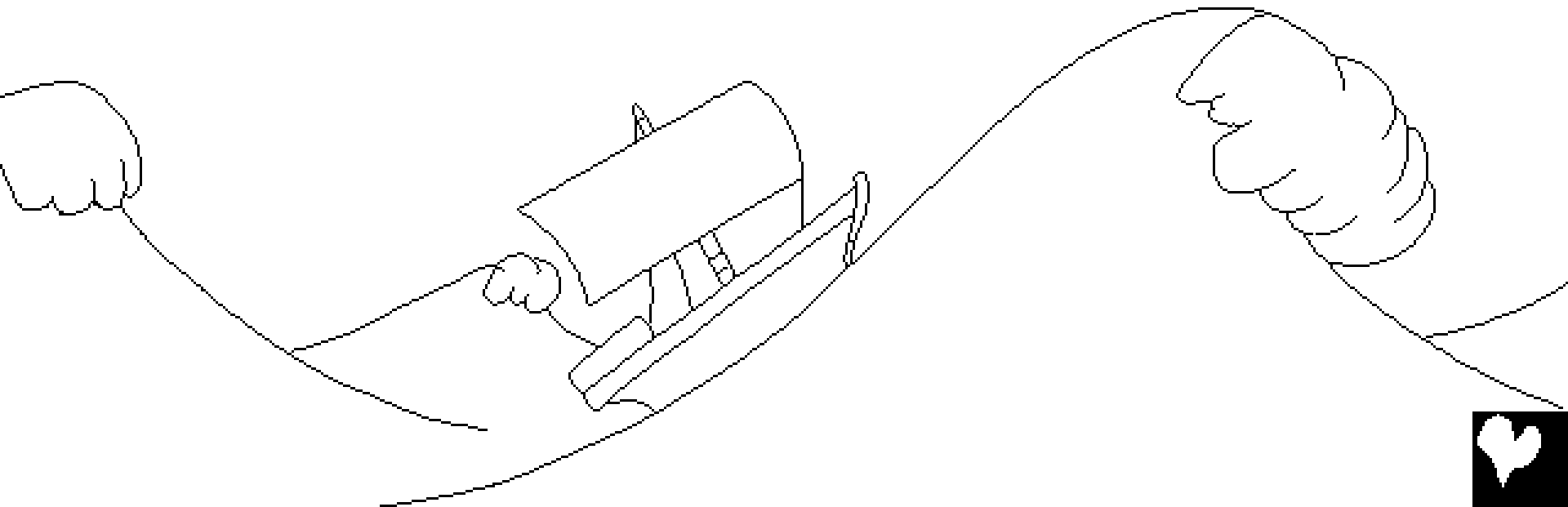

Ma rua ile punong aken i aoloaolo, mako imot
aken a umongare sawir or ma o nong a ole avalare
nge, lamako o asisespot ole ur elonga pelie ako o
paro tomo i a imot aken nge, ma o oma venen mo aro
imot aken i vthoa tie, ave
sivengaing e avele
i velpol.



Na Jona i nongnong vet inga a imot aken lemi na i nong kek avele, lamako imot aken a mukalinga i sangpolo i ako i nongnong, mako i presa ma i ria ve, "Ke voneke ako ong nongnong vet inga e? I pavurvur ako aro ong nong vet a lom God nge avele mo i opol it nge kerengaing ake, e?"

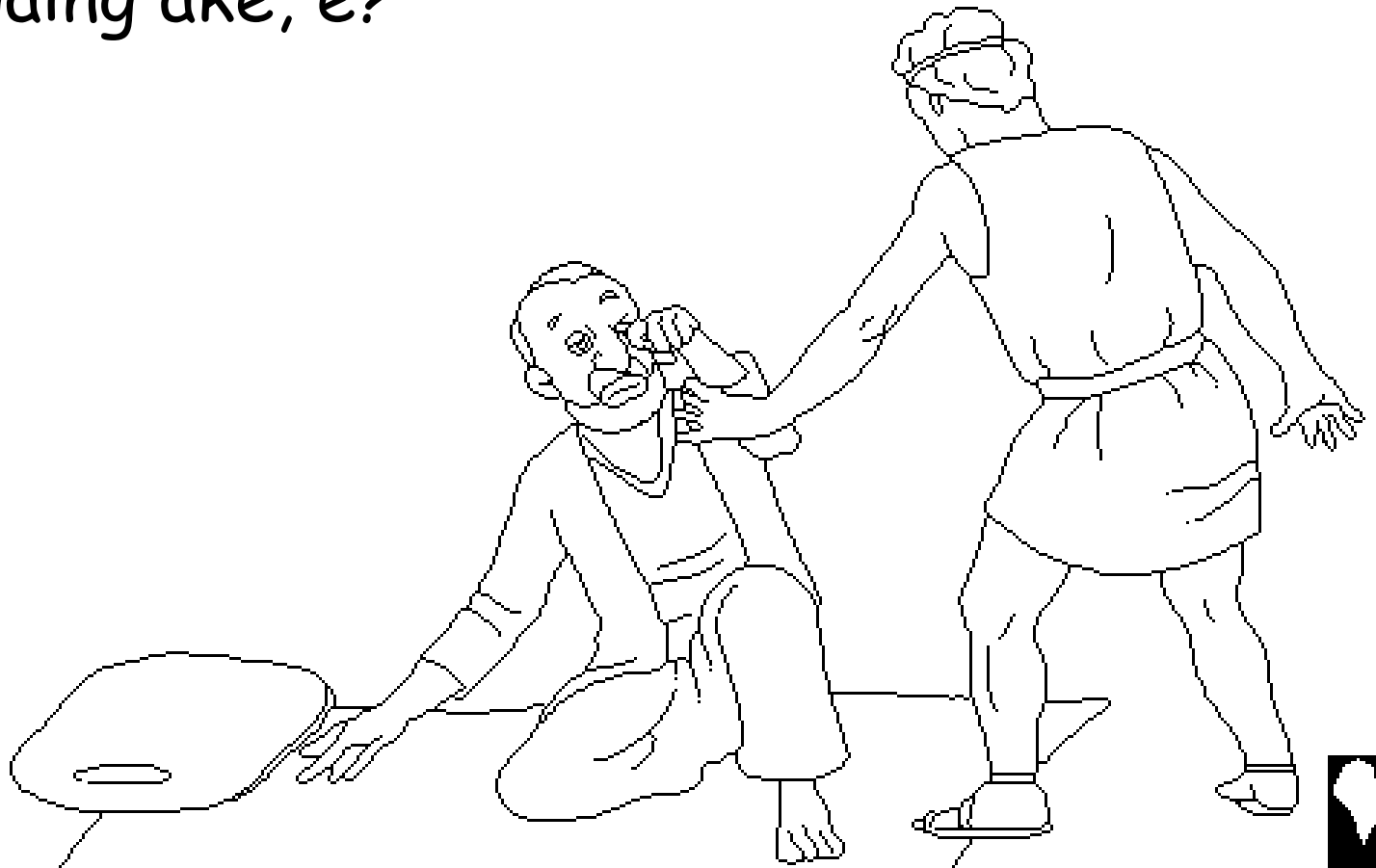

Lamako Jona i ria imot aken tokoninga ve kerengaing aken kene tepun ako nge i eneke, i lo nge a Patenger ile pakeing, mako o nina i ve, "Varo them voneke nge ong mo thev i ngo pisu e?" Mako Jona i ria or ve, "Aro thomu o asesu tho a thev lemi la mo ako aro rua i ngo pis wereru."

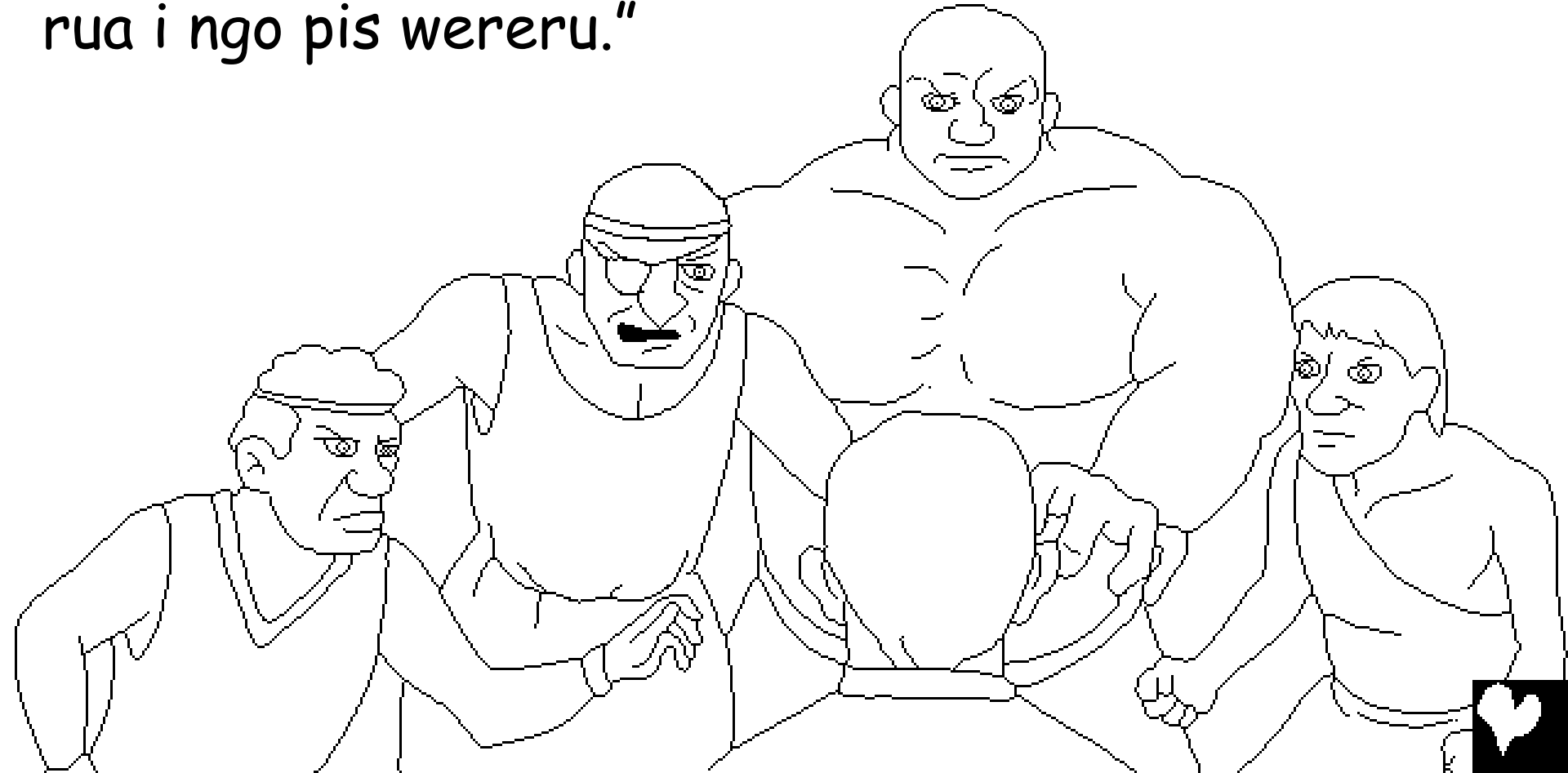

Ma imot aken a
umongare oni plong nge
a Jona iasespotnga,
mako o tongporum
ako ve aro o pasong
viriviri imot aken
a wopo la, ave
o pavurvur
ol avele.

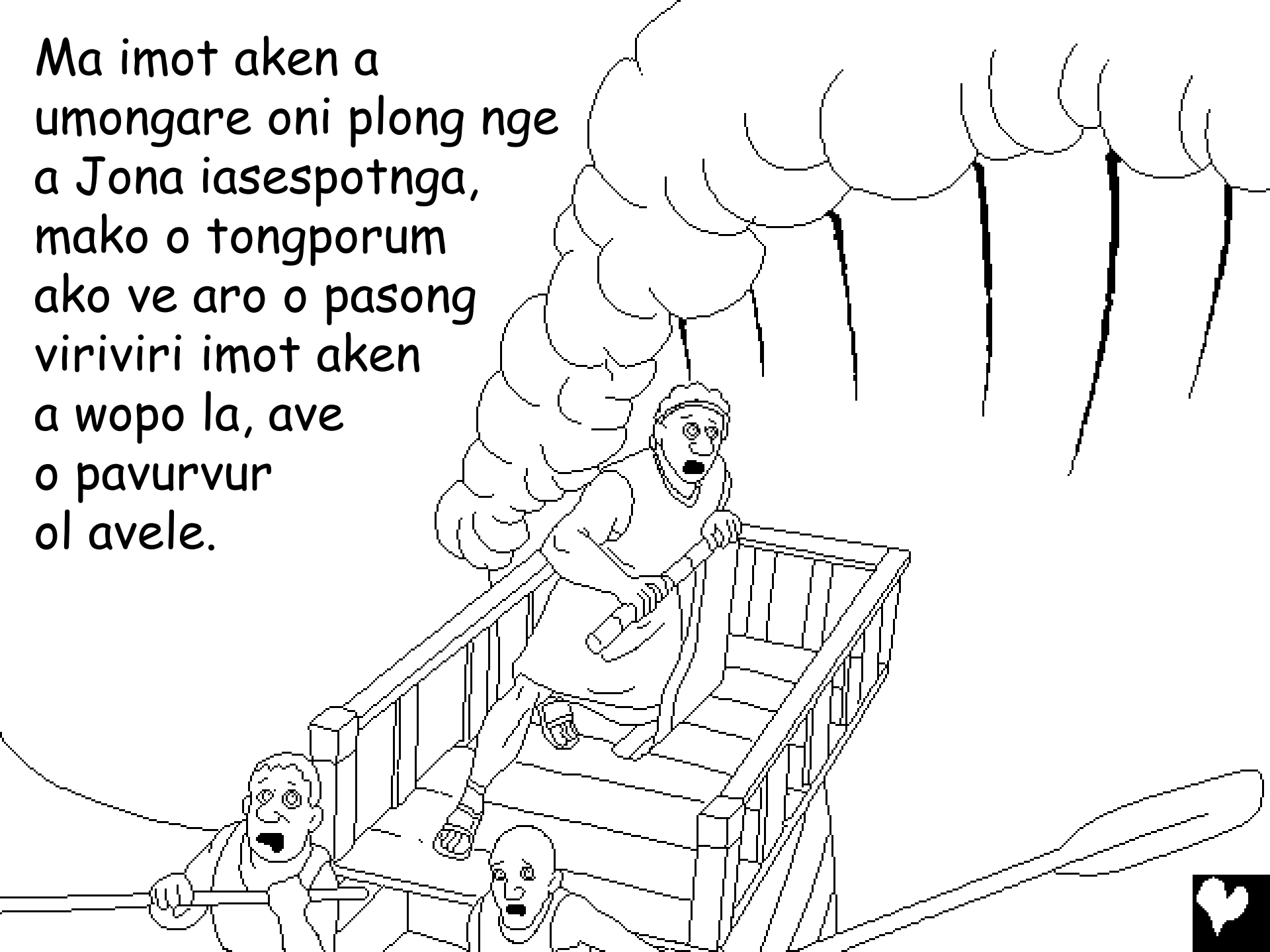

Mako imot aken a umongare o nong
ol a Patenger nge mo Jona
ile kerengaing
aken aro o
mit nge riong
avele, lamako o
asespot ol a Jona a imot
aken nge, ma i sivluku ol a thev
lemi la, nako mala a ur e avele
na thue ome thev le punong
aken i moru ol ma olemi
pelekpil na o ngeip,
mako o lotual ol a
Toko Pomnga nge.



Ma toko riong
avsanga aken i ri
tovanga aro toko
e avele i opoal ol
i na ilemi mire
avele ako aro
Toko Pomna aro i
opoal mun i.

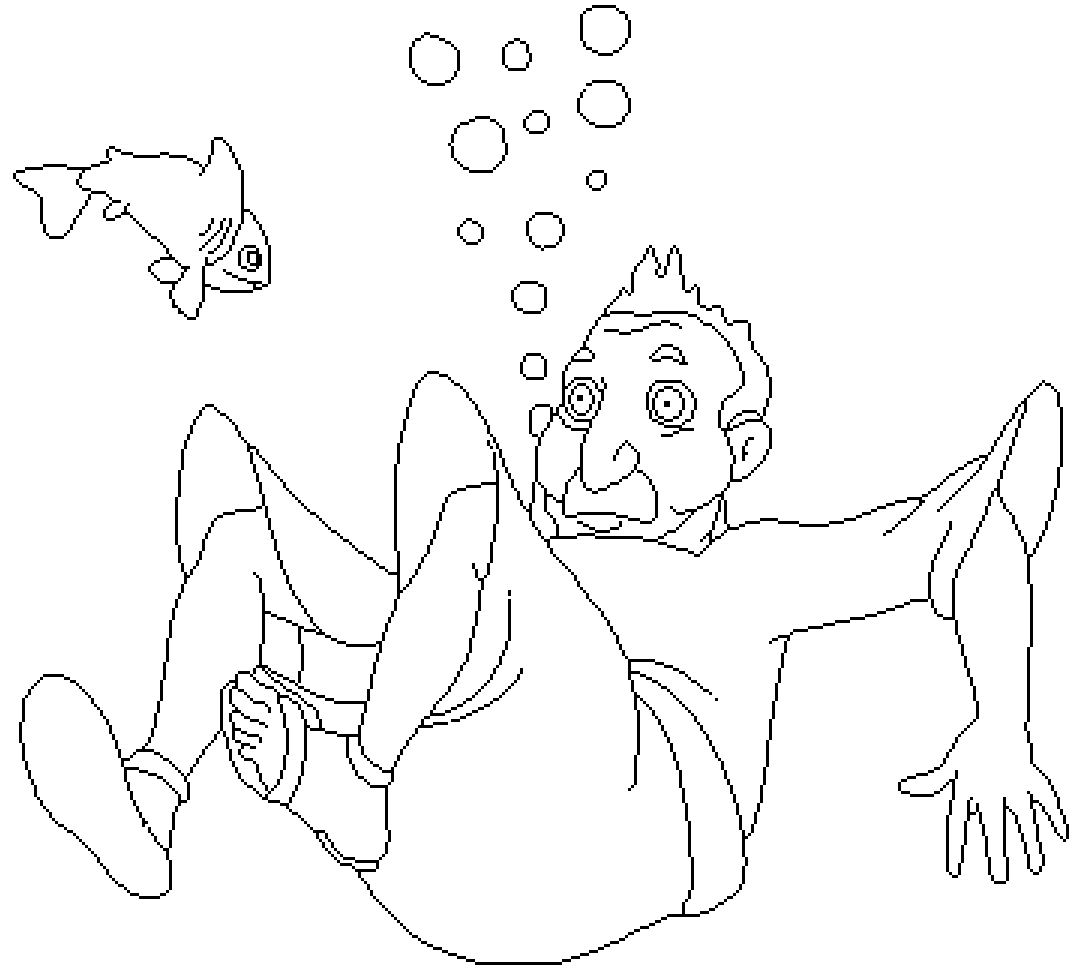

Na Toko Pomnga i mosi silanga
aolonga ako ma i mit vengtun nge pen
ako Jona aro i sivluk vengtun nge.
Mako a ur e avele na i ontetu a Jona
ma i voth a silang aken iopo lemi nge
nang orme, ma i el pasavilong aken,
mako i nong ol a silang
iopo lemi.

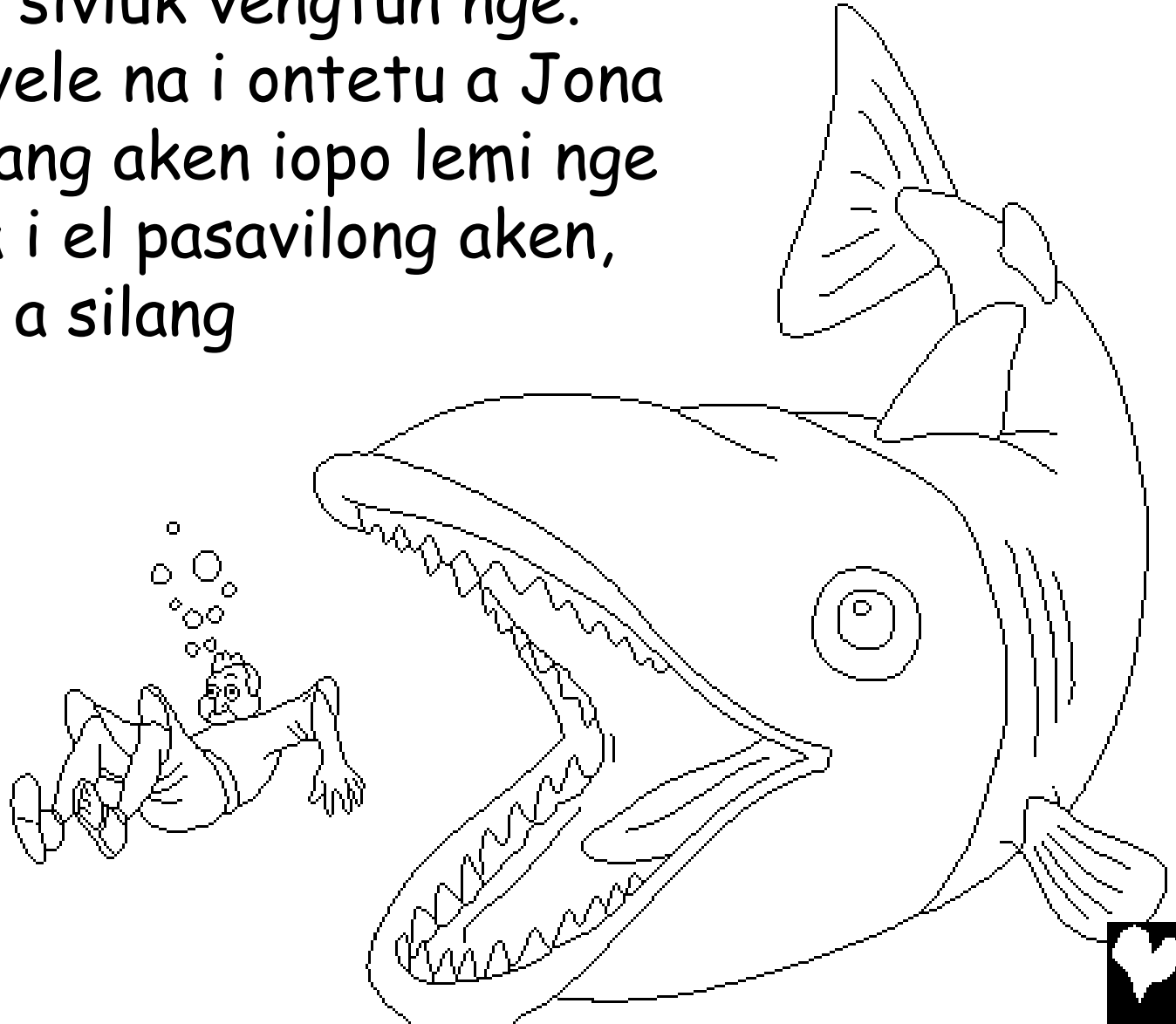

Ma nang orme i vus, mako Jona i ria ol ve, "Aro tho avsa ol a Toko Pomnga ile riong avele ol." Mako Patenger i ria ma silang aolonga aken i paeso i a wopo ma i muta i nge.

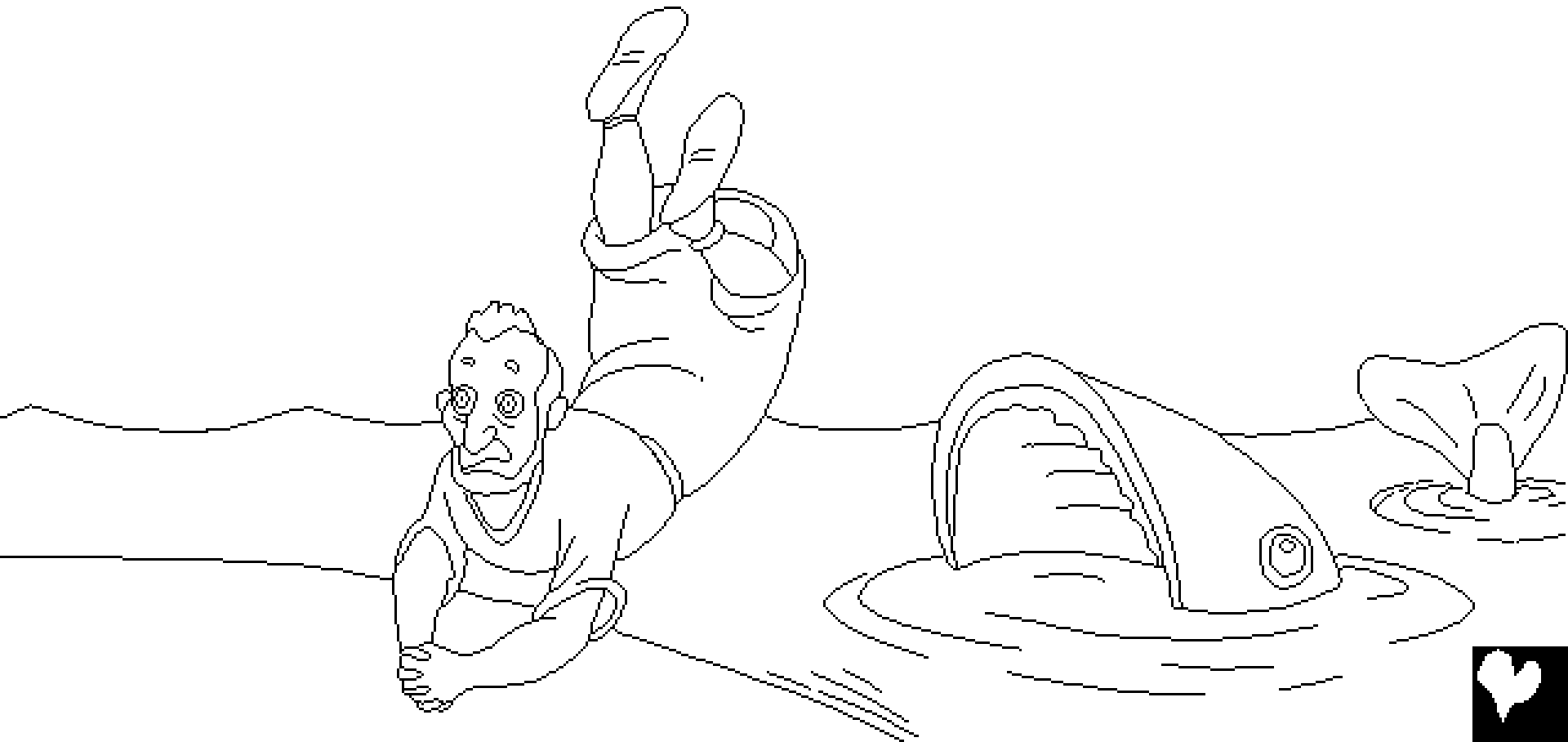

Lama Patenger i pake werer mun i mo aro
i es mo i panongpol nge ile riong a Ninive,
ma Jona i esa ol a Ninive ma i avavras ol
ma i ri ve, "Nang ormulepapenel aro i vus
aro Ninive aro i vusu."



Ma toko na seng Niniveanga areken olemio nge a
Toko Pomnga ile riong aken, mako o eksing olemi ma
o sem na o parara ole teunongre na o vor vuvus a opo
na o nong a Toko Pomnga nge mo i mothong tova i
pakerenga or.

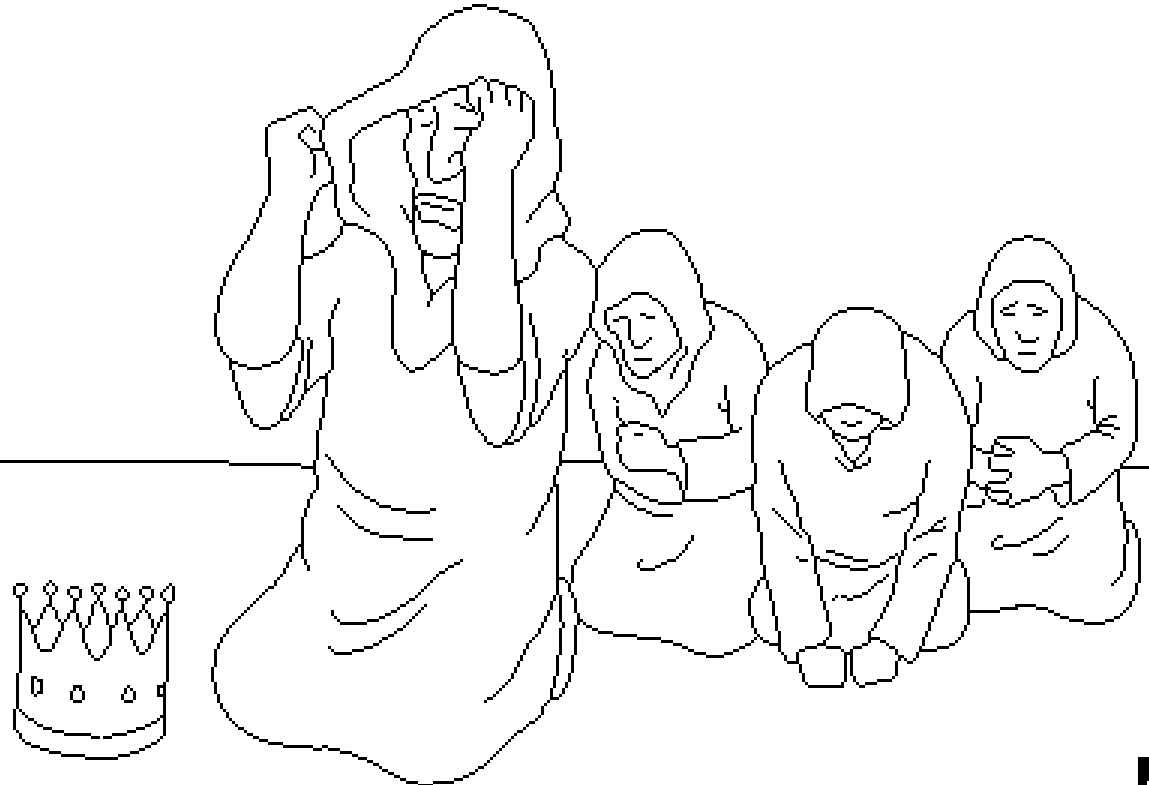

Ma Patenger ilemi eksing werer, mako i ikris werer
ile kinong aken ma nge nang aken seng na toko

Niniveangare peraling

aolonga i voth

a or nge. Na

toko inga

omole ako i

peral kek

avele ini

a Jona.



Na Jona ilemi kling eneke, Patenger i eksing werer ilemi, mako i ria Patenger ve, "Ong ini God asaguonga na ong vual nge lemi esaling na lomum kling viriviri avele, na ong vual mun nge vothung le sivengaing."

Na Jona i ri venen aken eneke, ilemi mire ako ve Toko Pomnga ilemi esal werer or lale. Aveto rongan ini silal or.



Ma ave Jona kene ilemi kling rintet, mako i ria Patenger ve, "Eltetpot lek mimiong eneke, mimiong ake i sivenga ol tho nge avele, naro i sivenga tova tho rin inga."



Mako Jona i lolepot rem pomnga aken mo i men na
i thepol vet aro Toko Pomnga i oma neke nge i. Na
Patenger i monsi we ako ma i pom viriviria nge nang
aken ma i velpol ini a Jona ile mlil.



Lamako nge rulponga nge nang aininga Patenger i pakepot mana ako ma i an vustetpot we aken ithoingre, mako we aken i rin sele. Lama Patenger i oma nang ma anreslanga i aolonga rintet ma i antun a Jona ma toth ako aro i rin nge. Ma i venen aken, mako Jona kene ile lemi klingong i aolo rintet ol nge.



Ave Ninive ini rempomnga
aolonga na toko na sengre o
mengmeng avele nge. Aken
aro lemik esal or.



Rurumong ake nge a Jonan
na silang aolonga

God ile erere a rurumong i voth nge

Jona

"God, lom riong i sung mire ninenga a
tokoere nge." Voing 119:130



Ireaken,
i vus



Rirumong sivesivengaere ako i voth a Patenger ile erere
lemi ako i pamen it alavusnga na i sis ve aro lemir mire nge ako ve ini ao.

Patenger ilemi mire nge ler vothung kerengare lale, na vothung kerenga
kene onga ini rinong, aveto Patenger ke kene ile asaguong i aulonga
rintet, mako i pakeu itun omolenga ako mo aro i mon a won ngoronga nge
mo ini ler vothung kerengare paolalnga. Ma i rin mako i mimi werer mun,
mako i voth ol a penaurvet! Na arove lomumo nge i na ong nong
tangosinga a i nge aro i eltetpot lom vothung kerenga na akennga i
nunganga aro i velpol ini ol om pomnga naro i mimi a ong nge naro i voth
tomo nge ong evelelnga ako aro ile vusonga avele.

Tova ve lomumo ve riong ake i nunganga aro ong nong ve, O, teik a Jisas
ong ini ok pomnga na ong ini Patengemem mun na ong velpol ini toko ma
ong rin nge lemem vothung kerengare lama ong mimi werera mun, make
ponange tho nong tangosinga a ong nge wot mo ako aro lomum simikal lek
vothung kerengare naro tho el mimiong ponganga. Na nge nang sivenga
omole aro tho voth tomo nge ong evelelnga naro ong opoal mun tho mo aro
tho nongal keum, naro tho panes ong ranga ve ini tum. Inunganga

Evelelnga aro ong tital a Toko Pomnga ile erere naro
ong lengleng tomo nge i nge nongong. Jon. 3:16

