

मुलांसाठी बाइबल प्रस्तुत

y;४; a;i[; m@;
mS;;



लेखक: Edward Hughes
रेखाचित्रकार: Jonathan Hay; Alastair P.
रूपान्तरकार: Mary-Anne S.
अनुवादक: Rev. Shilas Gavit
निर्माता: Bible for Children
www.M1914.org

BFC
PO Box 3
Winnipeg, MB R3C 2G1
Canada

©2026 Bible for Children, Inc.
परवाना (लाइसेंस): तुम्ही जोपर्यंत ही गोष्ट विकत नाहीत,
तोपर्यंत तुम्ही ती कॉपी किंवा मुद्रित करू शकता.



f::r v,{;pul* vsE;Al dæ::t; y;;æ; n;v;c;; Ak: muy;
r;h;t; h;ɛ;;. Akeidv,x;l prnæv,r;ney;;l ; s;v;ɾ; məe
a;i[; h;l x;;l l x;hr, innv,ey,ɛej;;[y;;s;

s;;]gt;l e t;ɛll l ;k: ik:t;l du!

a;hɛ; hedɛ;l ; miht; h;ɛ;e

y;;iv,{;y;l ty;;h;

c;ɛ;v, [;l dey;;s;

dɛ; ty;;l ;

p;@iv;t; h;ɛ;;.

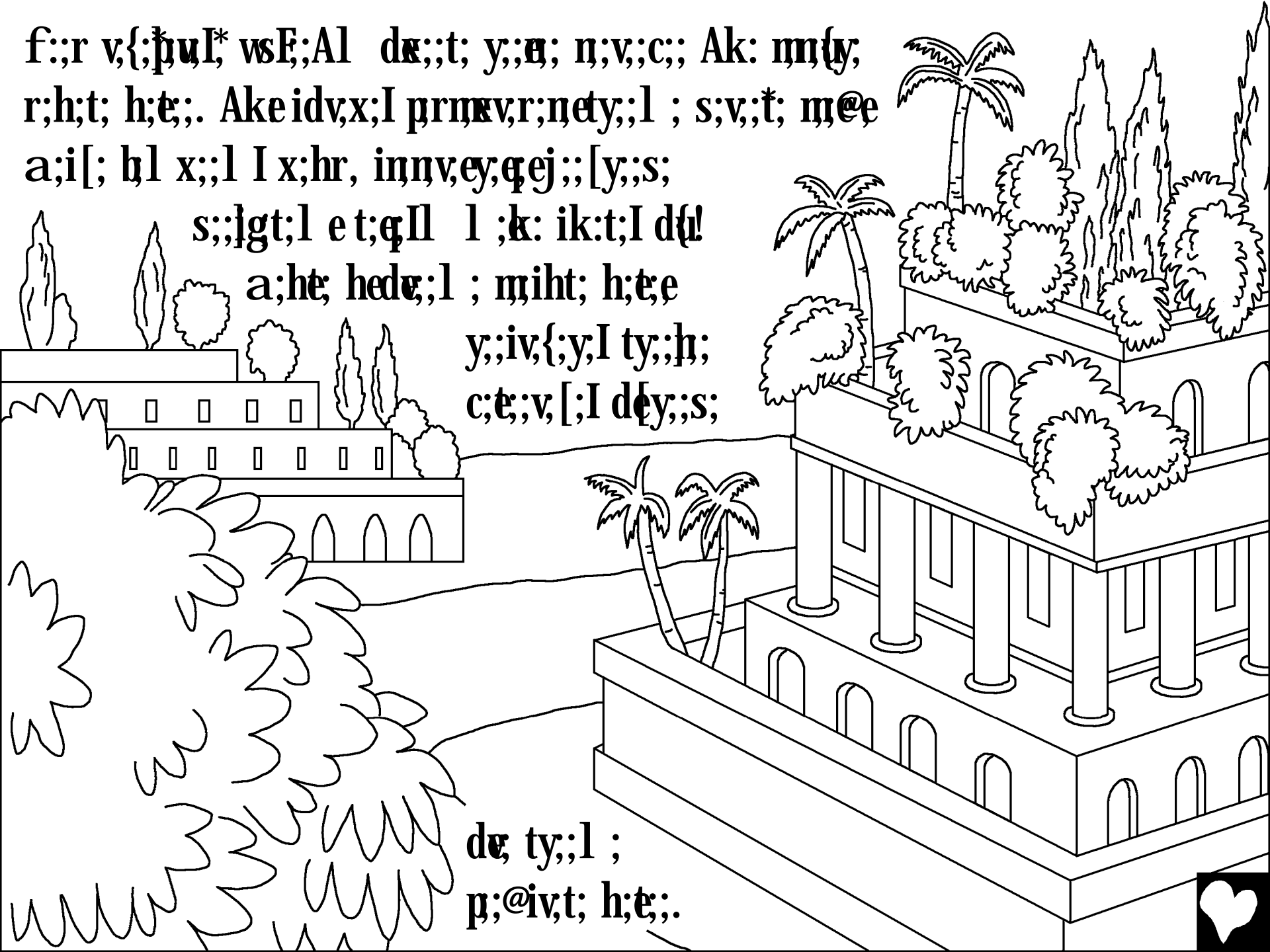

y; a; nede; cy; a; N; p; LDy; n; hl`
innv, e ; j; ; [y; Ae; j; l, innv, ey; iv, oQl<
idx; e ; as; l Dy; t; ; ix; x; x; hr; k; #e
j; ; [; ; Ry; j; h; j; ; t; y; a; j; ; ~n bs; l ;



t;h; p r n v, r d e; n e s; m d; t; p e; # v; y; u s;; # l ; a; i [; s; m d; t; m @ e t; f:: n
W @ l è j; h; j; f u l h h # t; e k: l k:: y; y;; x; k @ e k; l ; x; l G; h r l e h; e e

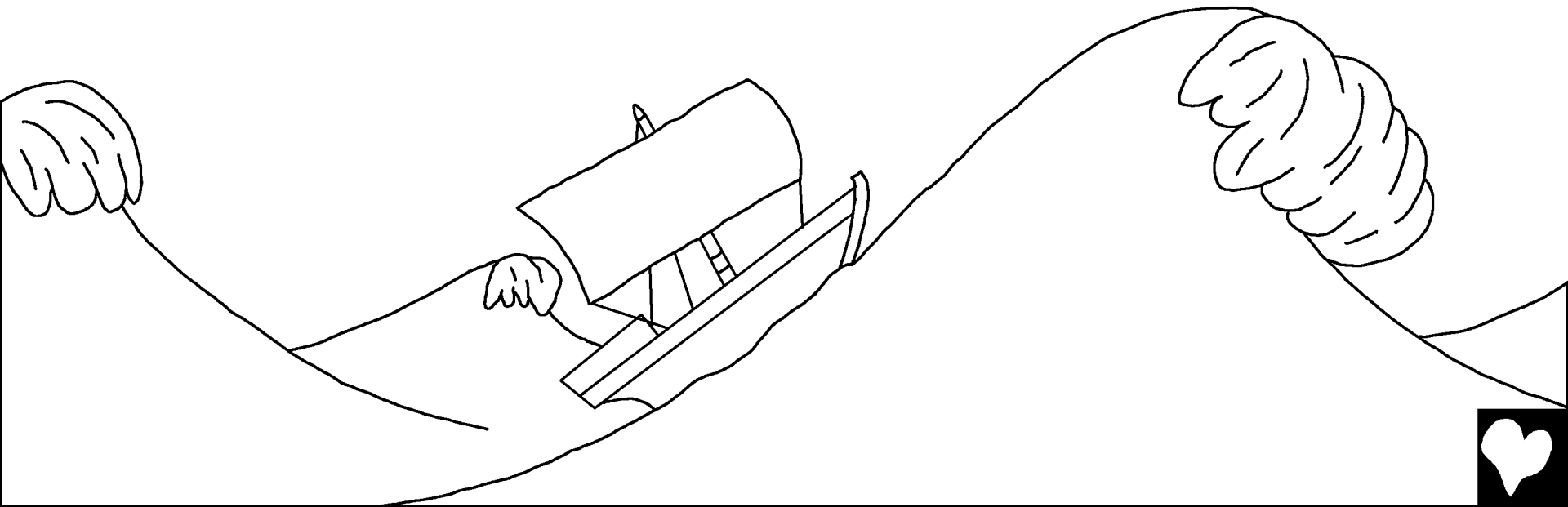

t;f::n aiQk::iQk: v;;St;c; g e G;hrl e eK;l ;x;l a;pa;pDy;; dEt;;t;l
p;qñ; k:o l ;gl ea;i[; j;h;j;;t;l s;;mñ s;mdst; fekñ j;h;j; hl ke
k:r[y;;c;; p;ytñ k:irt; h;te prt;Uk;;hl Wp;y; z;;l ; n;hl.



j;h;j;;t; as;l Dy; l ;k::pK:l y;;n; Ak:c; as;; w;ikt; h;e; k:l j;;ep;gñ;
k:irt; n;vht;;. t;;e;r j;h;j;;cy;; t;L;x;l j;;~n g;\$ z;;p Gē p#l ; h;e;.
t;h;l;j;h;j;;c;; t;;#e ty;;cy;;j;v,L y,e n m[;;l ;, "are z;;p Gē k;;y;
p#l ;s;? ~@, a;pDy;; de;c;; Q;v; k:r, n j;;[;;e;ede a;pDy;;k:#el Z;
dē , m[j;ea;p;l ; n;x; v;v;y;c;; n;hl."



ty;; K;l ;x;;h; l v,k:rc; s;mj;h a;l ek:l a;p[;;vr a;l Dy;; s;k:!:c;e
k::hlt;rl n;t;s;hQ y;;a; s;gt;l a;he y;;a;nety;;h; s;;]gt;l ek:l t;;e
de;p;s;h pLh j;;t; a;he t;h; ty;;hI ty;;l ; iv,c;;rl ek:l, "s;md>
a;mcy;;s;;@I x;;]t; vh;v;; mh[;h a;ml t;æek;;y, k:r;v;e" y;;a; ty;;s;
mh[;;l ;, "ml ; W;l h s;md;t; fekhh
dY;+k;;r[; mzy;;mLehem@ev;;dL
t;h;]r W@l ea;heheml ;
pkke@;~k: a;he"

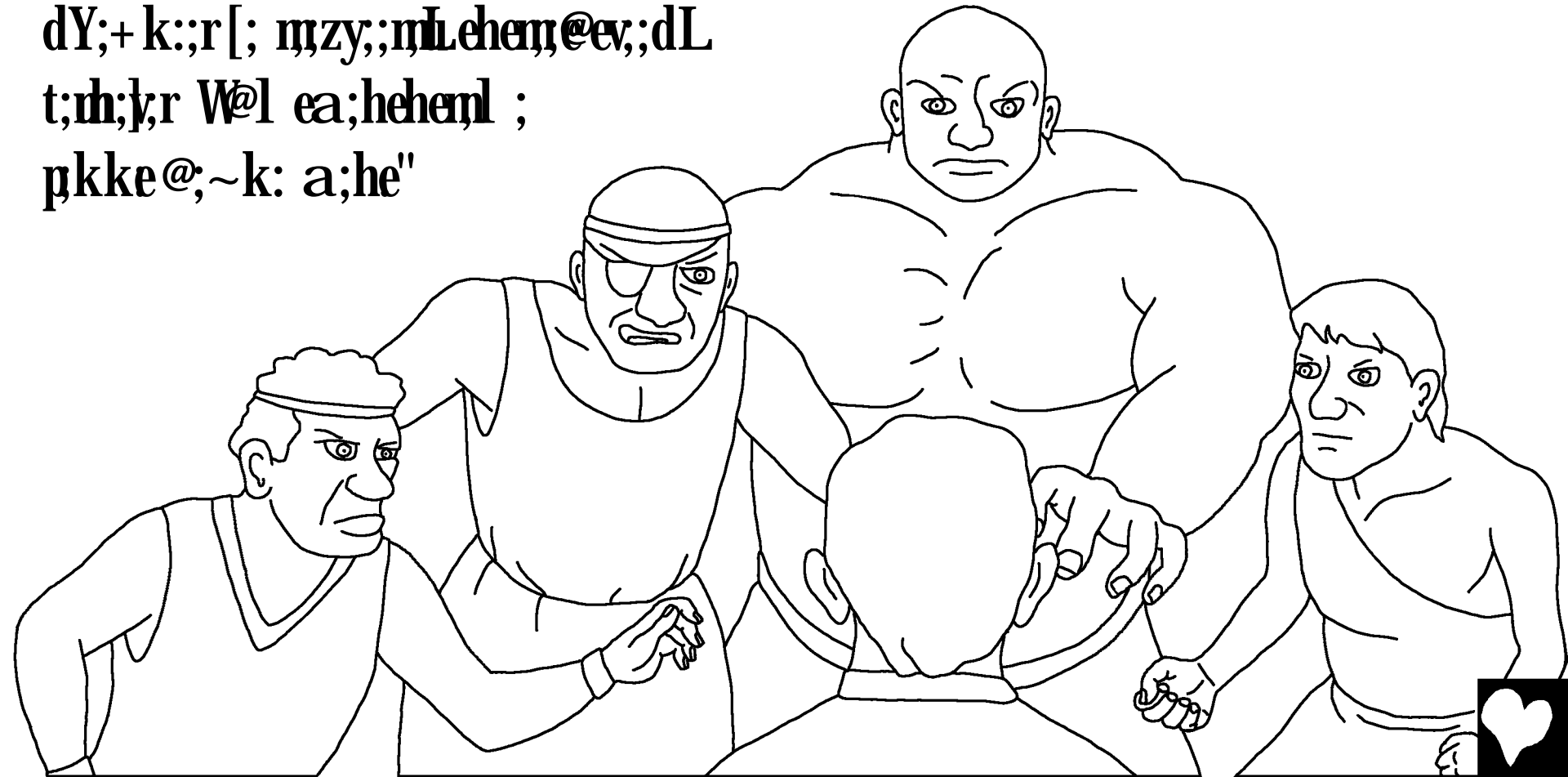

K;l ;x;l y;;a;l ; j;h;j;;t;H
s;md;t; fækUwic%t; nvt;e
m[;H j;h;j; ik:n;Ry;;l ;
l ;g;v;ey;;s;;@l ty;;hl B;rpU
p;yt; kel ep[; ty;;f; t;e
s;;Qa;. a;t;; kœ;L
Ak:c; g;é! k:r[;e
h;k:l r;ihl l h;t;l`



ty;; K;l ;x;;hI Z;me;l
p;ɣh; kel l, a;i[;
y;;a;l ; W;l h
ty;; s;mdɔ;
fekh idl e
ty;;hI y;;a;l ; j;s;e
s;mdɔ; fek:l eK;v,Ll e ; s;md>
a;i[; W;l[;;Ry;; l ;!; x;;ɔ; z;;Dy;;,
v;r; deK;l p#l ;. v;;dL inm[; z;;Dy;;mLe
K;l ;x;l j;e;SeG;hrl eh;e;ty;;cy;;pZ;; t;e
v;;dL Ak:dmc; x;;ɔ; z;;l ety;;mLet;r t;e
aiQk:c; G;hrl e de;c; as;ek:o
x;k:t;;ehet;ej;; [;h as;;v,e.
iB;t;l a;i[; a;xc;y;*k:irt;
ty;;hI pB;hI B;ikt; kel l.

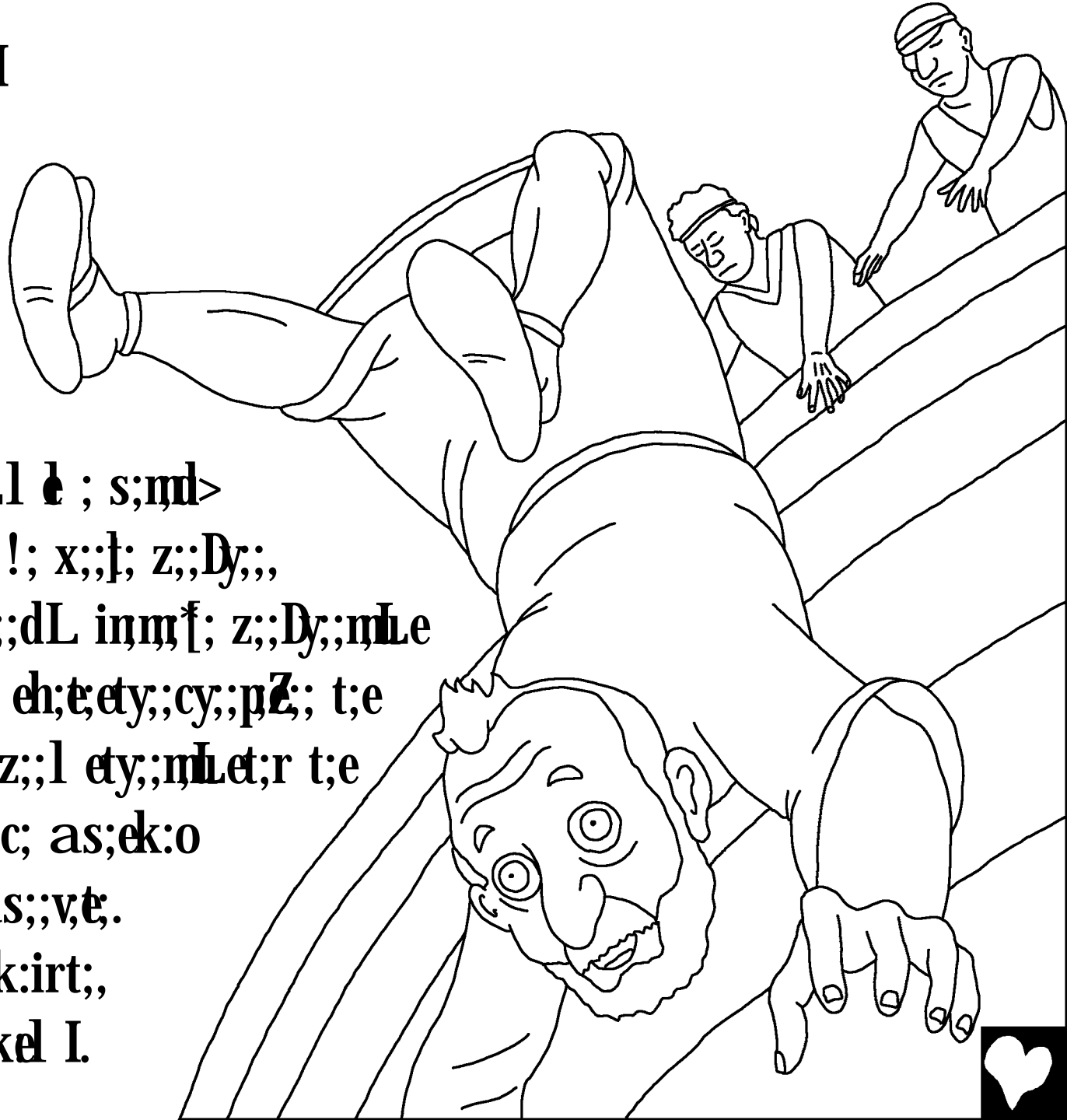

drɪŋ; ncy; k; L; t; a; N; B; g
k; r; ; R; s; h; v; h; k; l ; m; e;
a; x; c; y; ; c; Q; k; k; ; h; s; l ;
a; s; h; y; a; s; ; y; ; a; K; ; e
s; m; d; t; h; t; h; e; ; ty; l ;
m; i; h; t; h; e; e; k; l s; m; d; t;
h; t; y; ; p; s; h; ty; l ; a; t; ;
k; ; e; l; h; l v; c; v; l; k; t; n; h; l.

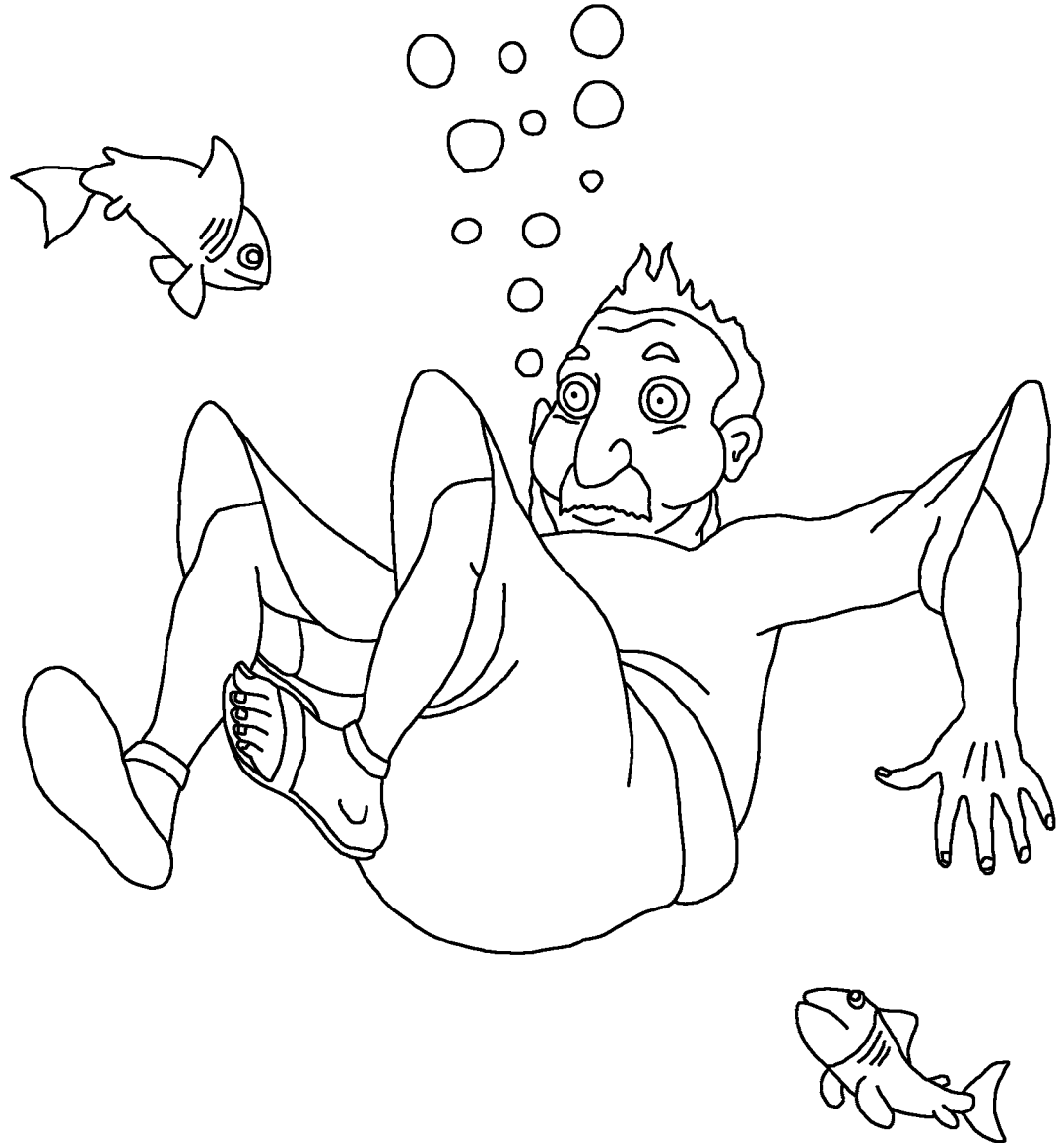

y;ǣ;l ; igL[y;ſ;;@I pǣſrǣv;r;neſ@Y;
m̄x;;c;l inim̄;l kel I h;e;l. m̄s;; agdI hr;ǣr
v,ǣt; t;ǣea;l ; ` Ak;;c; G;e;t,, y;ǣ; s;md̄t;ſ;
m̄x;;cy;; p;e;t; gē :. m̄x;;cy;; p;e;t; y;ǣ; it;n
idv,s; h;e;,. t;ǣety;;cy;;k:#eiv,c;;r k:r[y;ſ; v;
p;ǣñ; k:r[y;ſ; B̄rp̄ſv,ǣ h;e;.

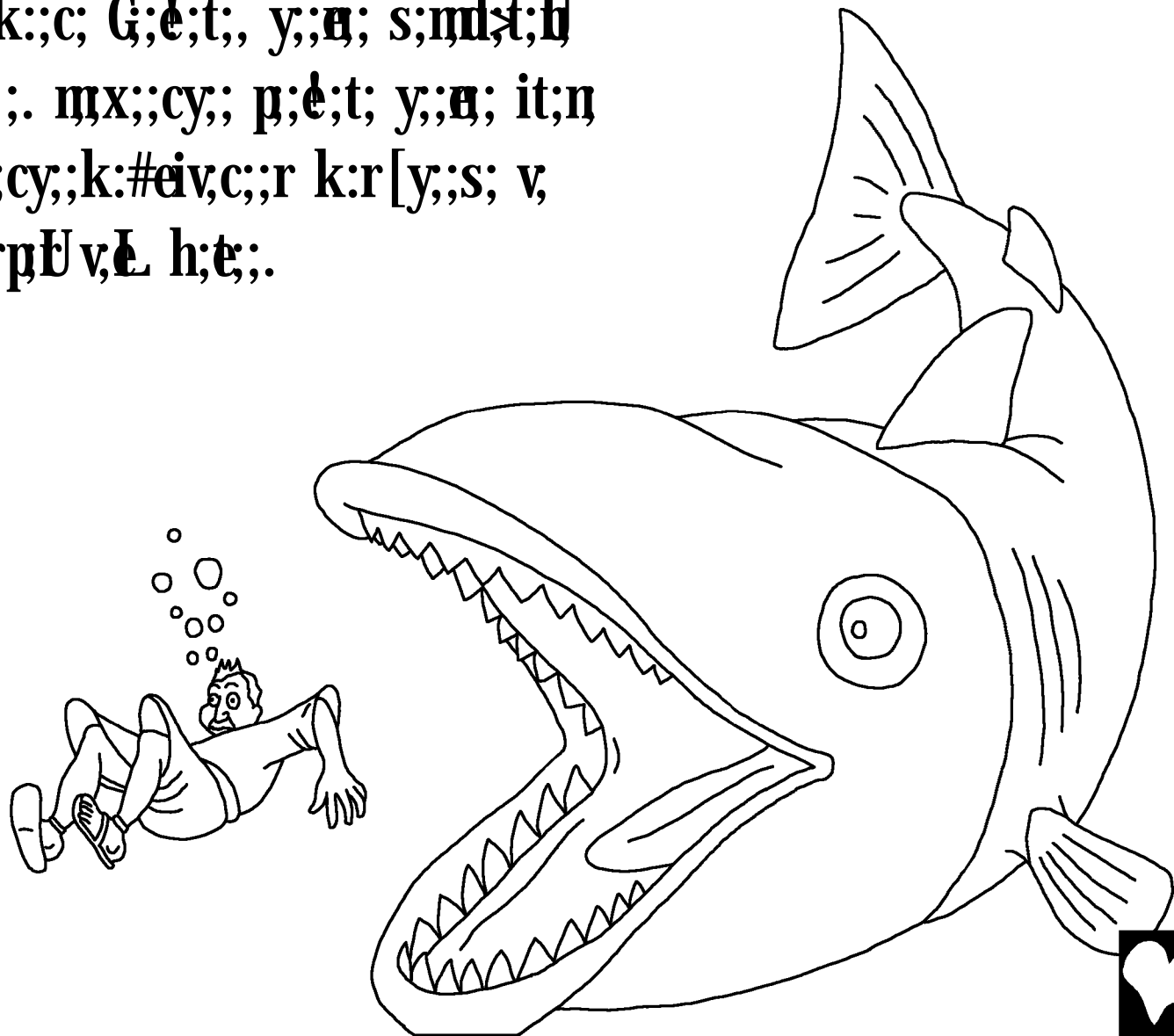

it;ŋ idv,s;;h̥r, d̥;cy;; a;N; p;L[y;;s; y;;a; aK;ɪrs; t;y;;r z;;l ;. ty;;c;
v,ɛɛ ;, p̥rɲv,r d̥;ɲɛx;;l ; a;N; kɛl I a;i[; ty;;ɲes;ɲɔ;cy;;
ik:ɲ;ʁ;;v,r y;;a;l ; a;kɪh̥ !;k:l e

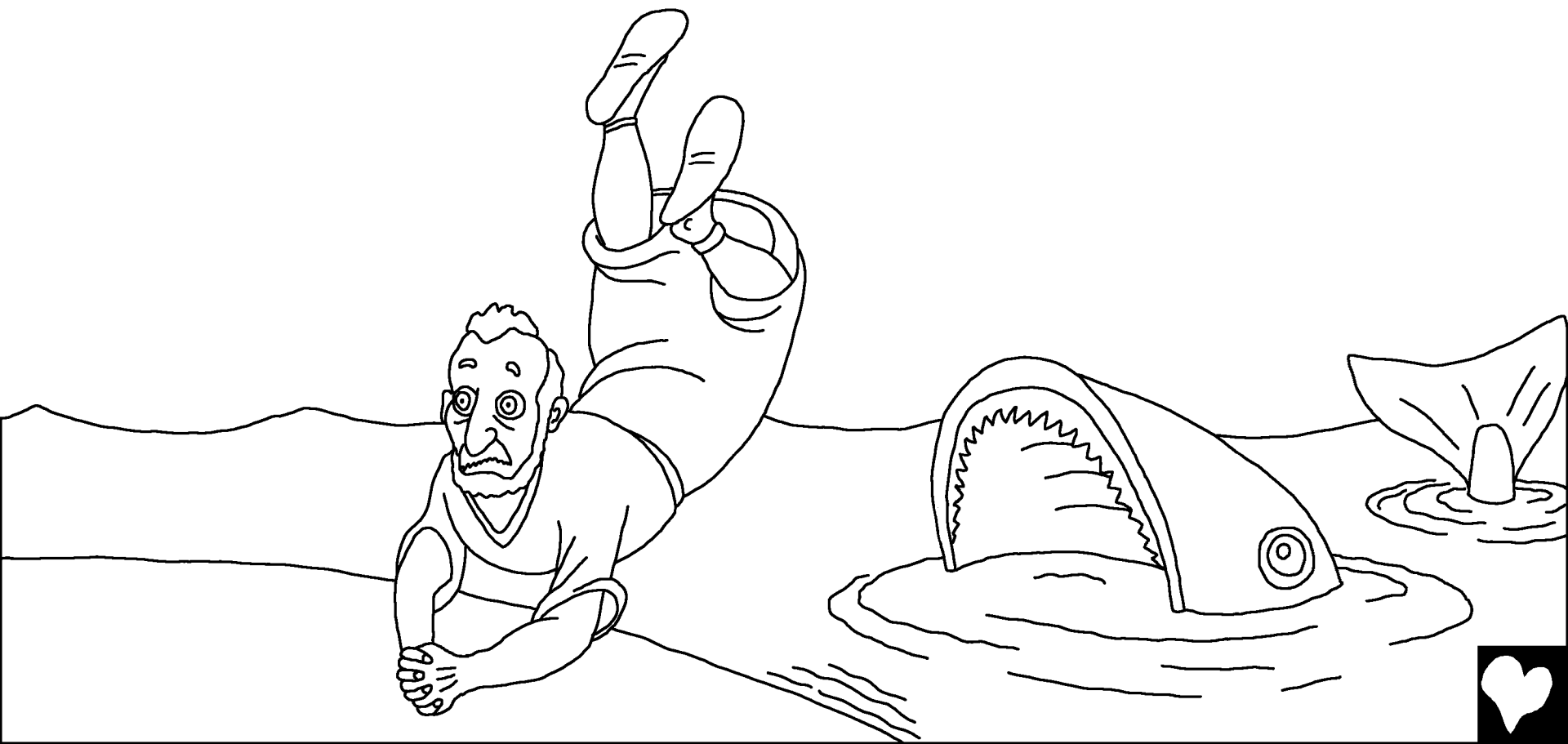

prh; Ak:d;, prnæv,r;ney;æ;l ; innv,ex;hr;t; j;;~n dæ;cy;;
v;c;n;c;; s;hæ; s;;g[y;s; s;;lgt;l ey;;v,LI, y;æ; gē ; ` "c;;LIs;
idv,s;;f;; av,k;;x; a;hæ mg innv,eQLIs; imLē . " as;ea;e#H
s;;gt; y;æ; innv,ex;hr;t; if:rl ;



innv,ex;hr;t;ll l ;k::hI de;cy;; v,c;n;v,r iv,xv;;s; @e,l :. a;ml j;ep;p
kel ea;hety;;iv,{;y,I a;ml dIK; vy,kt; k:rt;;eas;edx;iv,[y;;s;;@I ty;;hI
Wp;s; kel ; a;i[; g;e;t;;!;c;I k:p#eG;t;l I. Ae;Se; nvheter prmæv,r;s;me
r;j;; diK;l nmz;;l :. t;;ety;;cy;; r;j;;s;n;v,on W@l ;, g;e;t;;! ns;h
r;K;e hs;l :. ty;;nepty;k::l ; ty;;ty;; d(u' mg;p;s;h v, ih;k: v;T;lp;s;h
mgeif:r[y;;s; a;i[; prmæv,r;ne
ty;;t;I Zm k:r;v,I m[:h
p;æh; k:r[y;;s; s;;]gt;l e

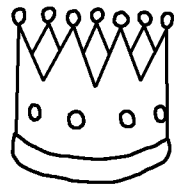

de;nety;ç;I Z;m kel I` de;nety;ç;I Z;m kel I a;hehej;h; ty;;h; k:Ll et;;e
idv,s; innv,ex;h;r;t;ll l ;k;;ç;;@I f::r m@, a;nçc;;, adBt; idv,s; @rl ;

as;;v;; ... p[; Ak;; w;ikt;l ;

f;;r r;g a;l ;

h;ç;; y;;h;`



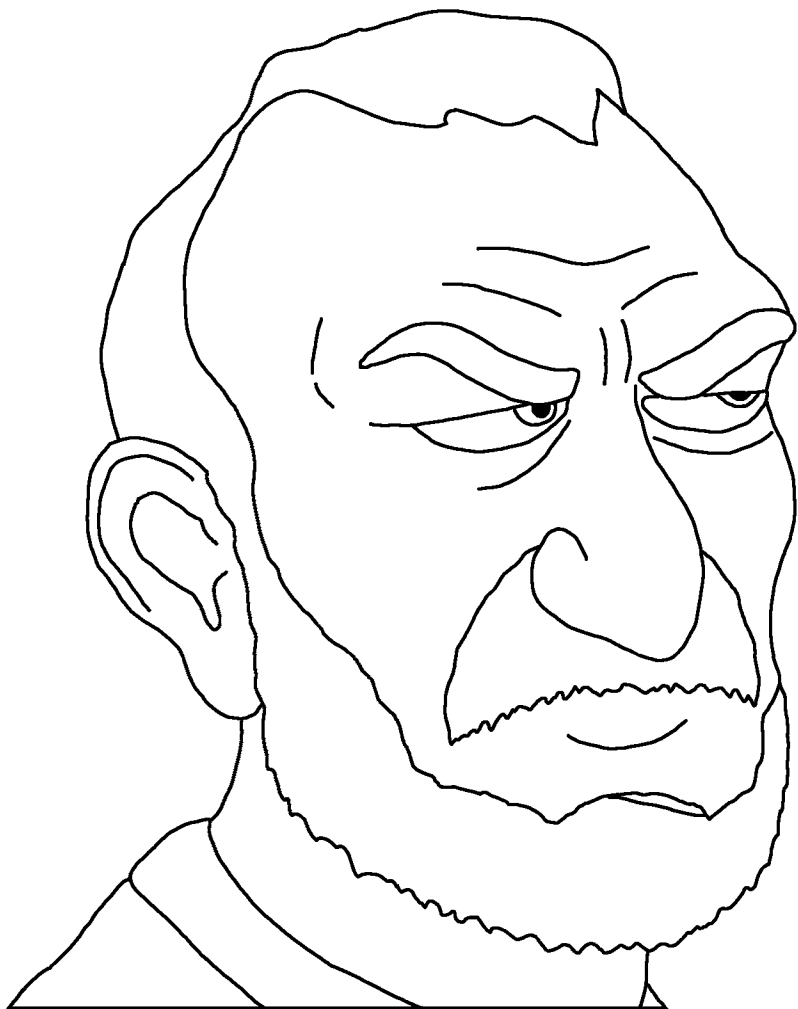

y;æ;l ; r;g k; a;l ; h;e;? t;;e
pɾnæv;r;l ; m[;l ; "ml ; m;ht;
h;e;ek:l, t;|k&;L|Uk:nv;;L|U|k>;@,
dy;;s;ɸm, as;; dæ a;hs;" dæ;Ry;;
x;bd;t; s;;g;y;c;et;r, j;ek;;e;l dæ;c;e
v;c;n Ak|h ty;;c;ea;N;p;l n k:rt;;t,,
ty;;ɸy;; p;p;|v;{;y;l v;w! v;|H ty;;c;l
Z;m mgt;;t; ax;; p;ty;k;;c;l pɾnæv;r
Z;m k:rt;;e hey;;æ;l ; a;iQp;s;Hc;
m;ht; h;e;e as;ev;|t;ek:l y;æ;l ;
innv,e;el ;k: a;v;#t; ns;;v;e ty;;ɸ;l
Z;m v;h;v;l ax;l ty;;c;l w%; n;vht;l.



y;æ;l ; y;iv,{;y,l dæ;c;; f::r r;g a;l ; m[;h t;;eas;eh[;;l ; k:l, "he
pɹɪæv,r;, mɜz;; p>[; Gɛ k::r[; j:g[y;pʒ;; ml ; mɹ[; bɹev; !t;e"



a;t;; p r n v,r p s e k::y; k:rt;;e h e p;h[y;;s;;@l, y;;a; x;h r;cy;; b;h e j;;~n
h s;l ;. p r n v,r d e;n e n@Y; p;n;t;; A k: v,e W g i v,l ;. t;;e v,e l v,k:r
v;;\$l ;+ t y;;c y;; s;;v,l l n e y;;a;c;e s;y;*c y;; W [;t;p;s;h s;p U;*i d v,s;B r r Z; [;
z;;l e



ds;Ry;; idv,x;I s;k::LI, prnkv,r;neAk: ik:#; Wpm kel ;, t;;ety;; v,e II ;
l ;gDy;;mLet;es;kh ge e ty;;n;r prnkv,r;nez;Lw*; v;r; wt;k;; v;hiv,l ;
k:l, ty;;mLenl m e ehreas;ey;;u;neiv,c;;r kel ;. y;; s;v;;mley;;u; aj;h
aiQk:c; r;g;v,l ;.



ng prnɛv,r dɛ;ney;ɹ;l ; m!l ɛ "r;gv,[y;;c;; t;ɰ ;
k;;hl aiQk;;r a;hek;;? y;; v,ɛ ls;;@I t;ɰ ; k;;hl Xm
p#l ɛn;hlt;, t;ɰhl ; v;;\$iv,l ɛn;hl, hl Ak;;
r;ɛlt; v,r a;l I v, Ak;; r;ɛlt; mɛ I, ihc;I
t;ɰt;k:I p,v; *k:irt;;s;`
t;r hj;;r;el ;k:

as;l ɛ e
m;ɲ x;hr
inɲv,ey;;c;I mɪ
p,v; *k:o ny,ek;;y;?"

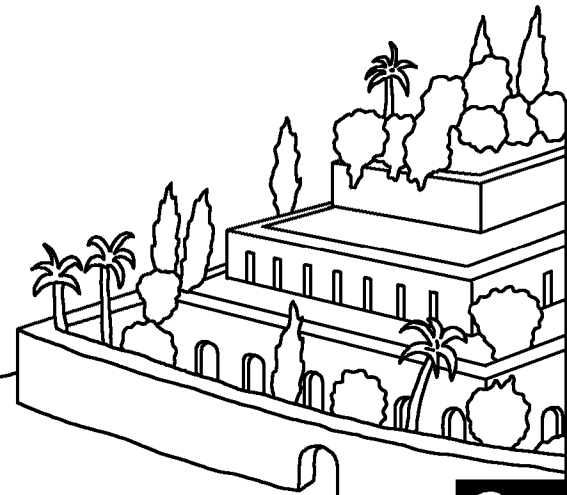
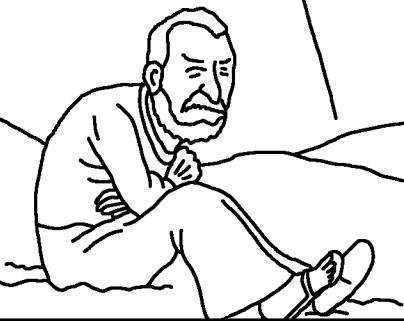

y;h; a;i[: m@; ms;;

prnkv,r;c;l वाणी - बाइबल मधून गोष्ट

Gey;t; a;l l आहे

y;h;

"t;ny; v,c;n;cy; W g#Y;nek::x; p;pt; h;e;e"

st;;Es;|ht;; 119/130



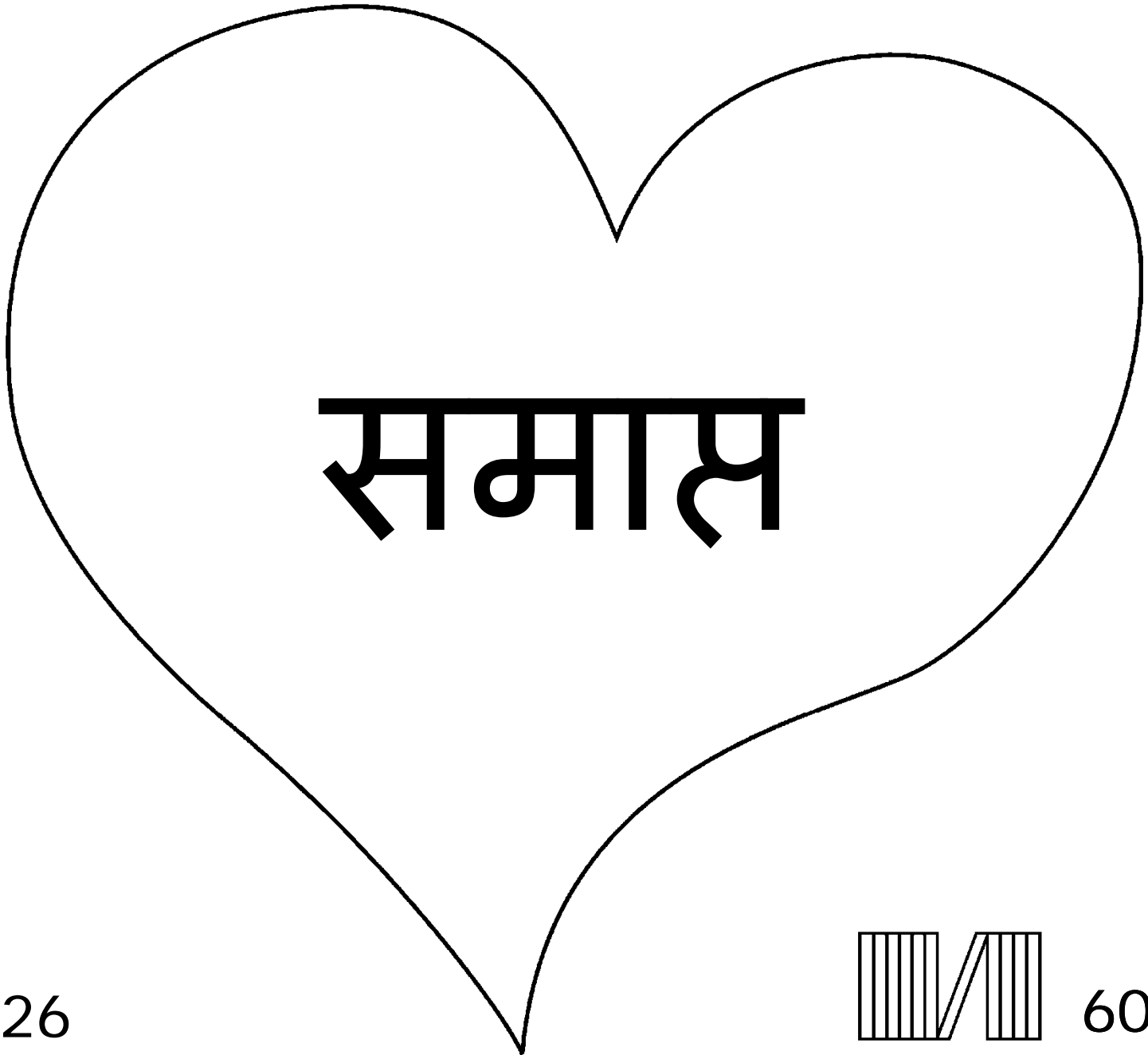

26

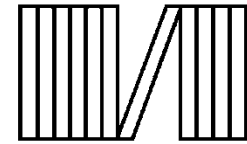

60



बाइबलमधील ही गोष्ट आम्हांला आमच्या सुंदर प्रमेवर,iv,{;y,I सांगते ज्याने आम्हांला बनविले आणि ज्याची ax;Iwc%; आहे की आम्ही त्याला ओळखावे.

प्रमेवर;l ; माहित आहे की आम्ही वाईट गोष्टी केल्या आहेत, ज्याला तो पाप म्हणतो. पापाची शिक्षा nr[; आहे, पण प्रमेवर तुमच्यावर इतके प्रेम करतो की ty;;l ; तुमच्या p;p;t;l शिक्षा मिळावी आणि v,Qst;B;v,r nr;v,म्हणून त्याच्या Akul t;; Ak: pfi y,x;Uj;;l ; पाठविले. नंतर y,x;Uj;v,t; z;;l ; आणि sv,g;t;ll घरी गेला. जर तुम्ही येशूमध्ये विश्वास ठेवता आणि तुमच्या पापांसाठी त्याने क्षमा करावी अशी त्याला विनंती करता, तर तो नक्की क्षमा करील. तो आता तुमच्याबरोबर येऊन राहील आणि तुम्ही त्याच्याबरोबर कायम राहणार.

hes;ty, a;hey;;v,r j;r t;rhI विश्वास ठेवता, तर प्रमेवर;l ; हे सांगा:
प्रिय येशू, तू प्रमेवर आहेस आणि माझ्या पापांसाठी nr[; p;v,[y;;s; मनुष्य hnI ; आणि आता तू ij;v,t; a;heयावर माझा विश्वास आहे. कृपा करून माझ्या जीवनात ये आणि माझ्या p;p;t;l मला क्षमा कर, जेणेकरून आता मला नवीन जीवन प्राप्त होईल, आणि Akeदिवस मी कायम तुझ्याबरोबर राहण्यासाठी

y,श्री. तुझी आज्ञा पाळण्यासाठी आणि तुझे मूल होऊन जगण्यासाठी मला मदत कर. आमेन.

बाइबल वाचा आणि प्रमेवर;x;l रोज बोला! y;;h;n 3:16

