

www.BibleForChildren.org

Uan 14

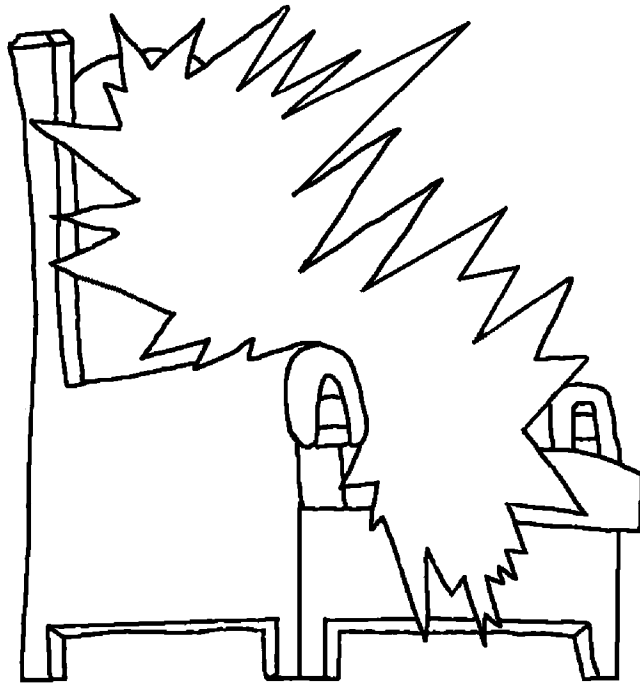

Aden chuisho tantiash ubitedi natic tabadsho isashien
Esus: Natienda. Ubi dayun uaquid nec, quequin Nuquin
Papa tantiata. Adembidi tantiaquin ubitsen tantiaquiota.
Cun Pan shubu yacno quënë dadpenquioshēcquid
tsucustiapimbo iquendac. Adquidpenquio icsho mibi
aden chienquio
ictsiambi.

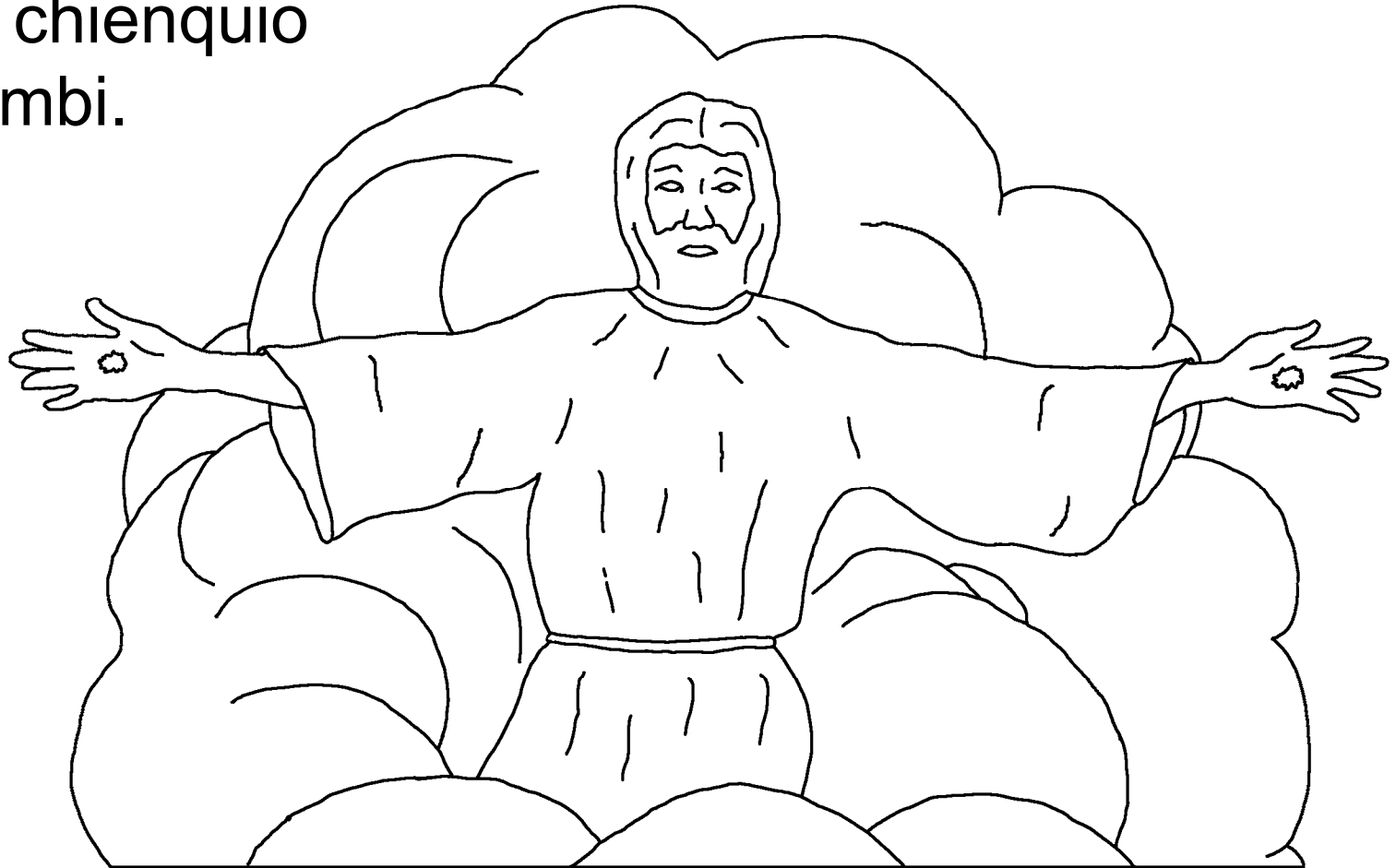

Adquid tantiaquin: Ubi tantiaquido ubëdi
tabadmendambi, quequin chiombi. Adquid iquec,
quiash ubia nidshun: Ubi tantiaquido nëmbo
tabadmetiad, quequin Cun Pa chiendambi. Adashic
ubi yacno ubëdi tabadmenuen mibitedi bednuec
chouaindabi.

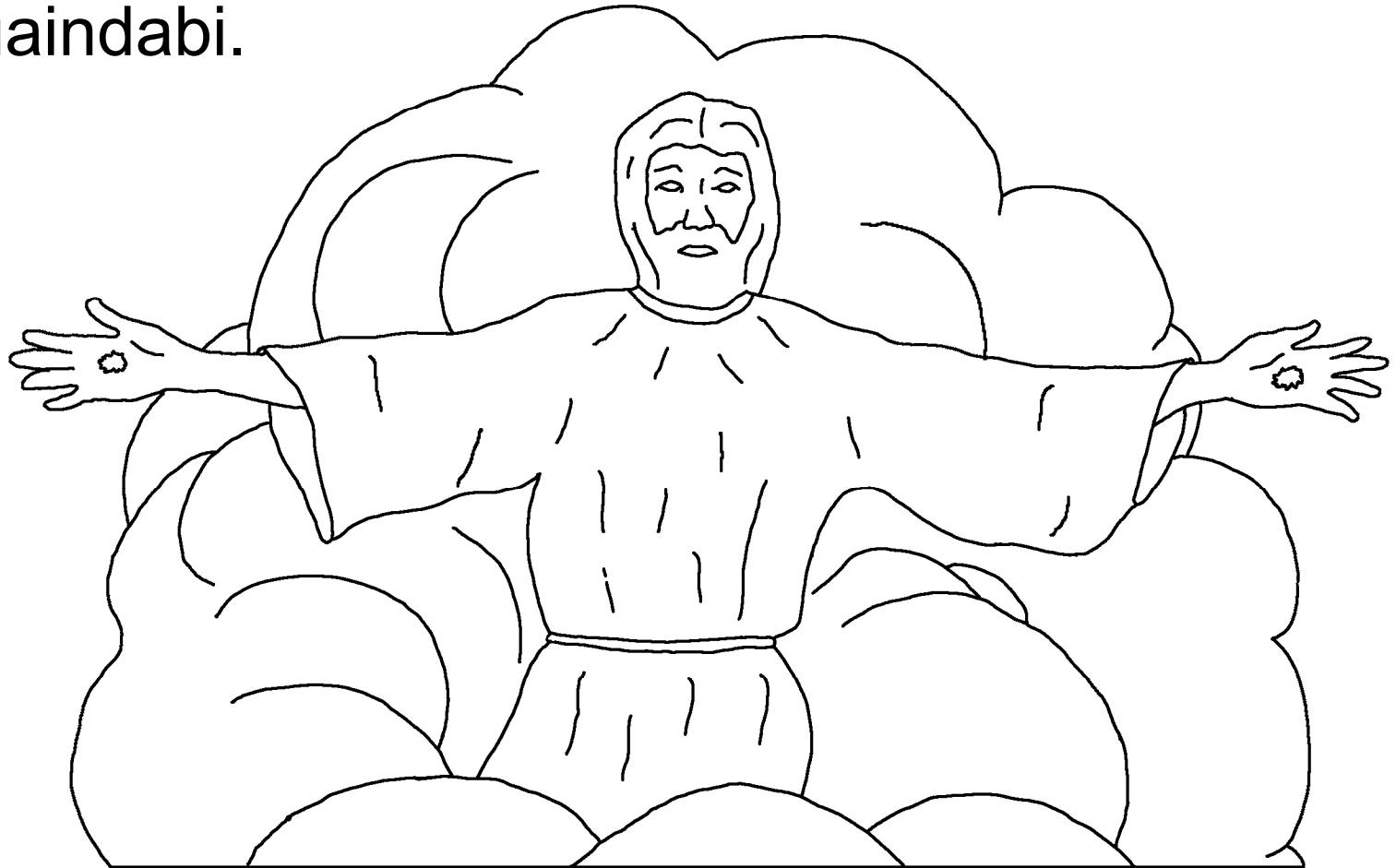

Esusböd iccondaidquio Uan nebi. Mibëtan Esus
tantiaquid yec min utsi nebi. Esus tantiaquid
icscho Nuquin Papan namiaido yec

aidböd tabadtequido
nuqui nec.

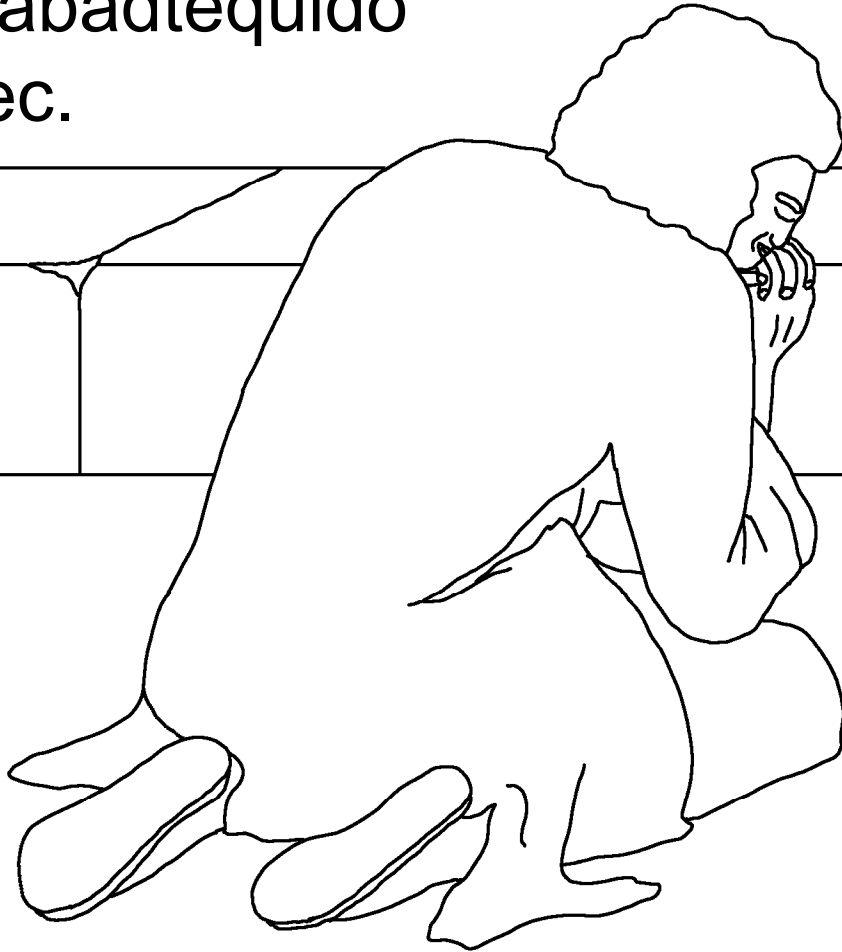

Esus tantiasho mibi natiamequin
chieshënacpadembidi Esus tantiesabon
chieshëmpondashi. Adoaqui Esusën

namiacpadec chieshtoenquo icquin abi
Esus chuibenniondambi.

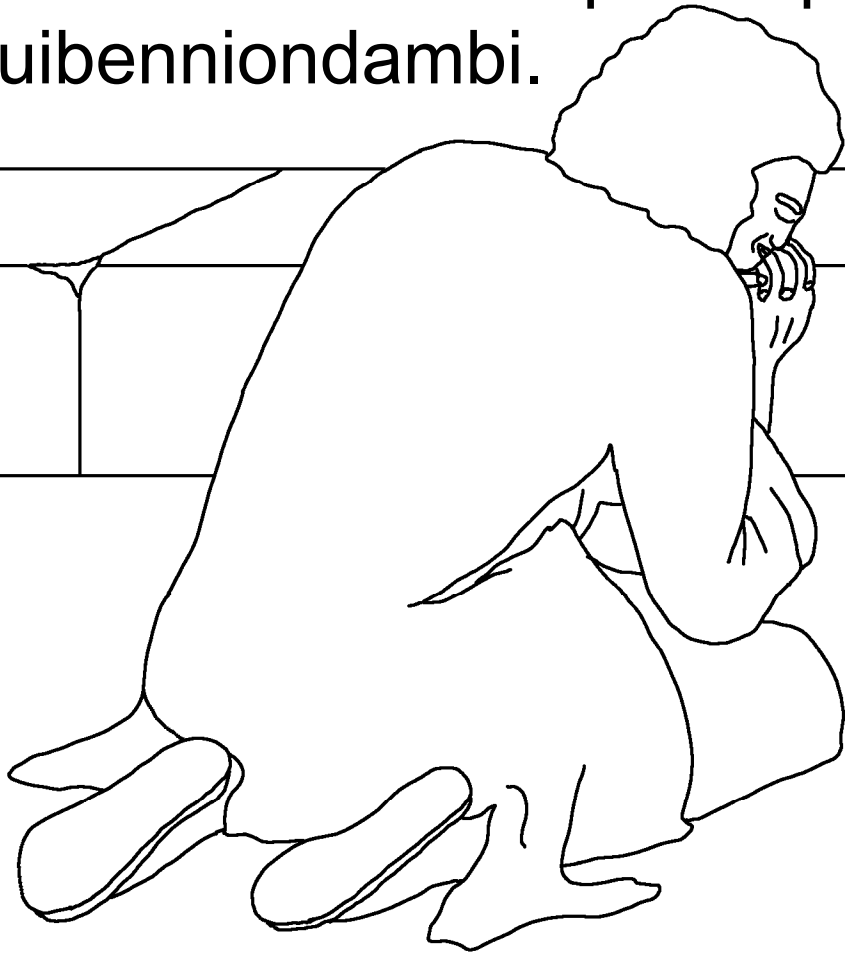

Adsho issun Esus chieshënquidon quënën
tsadunacimbuen cuenmenquio icnuen acte
dapa mad caid nidaid nacbëdquid tapa

Padmos caidën tsadunondac
abi tsadec nebi.

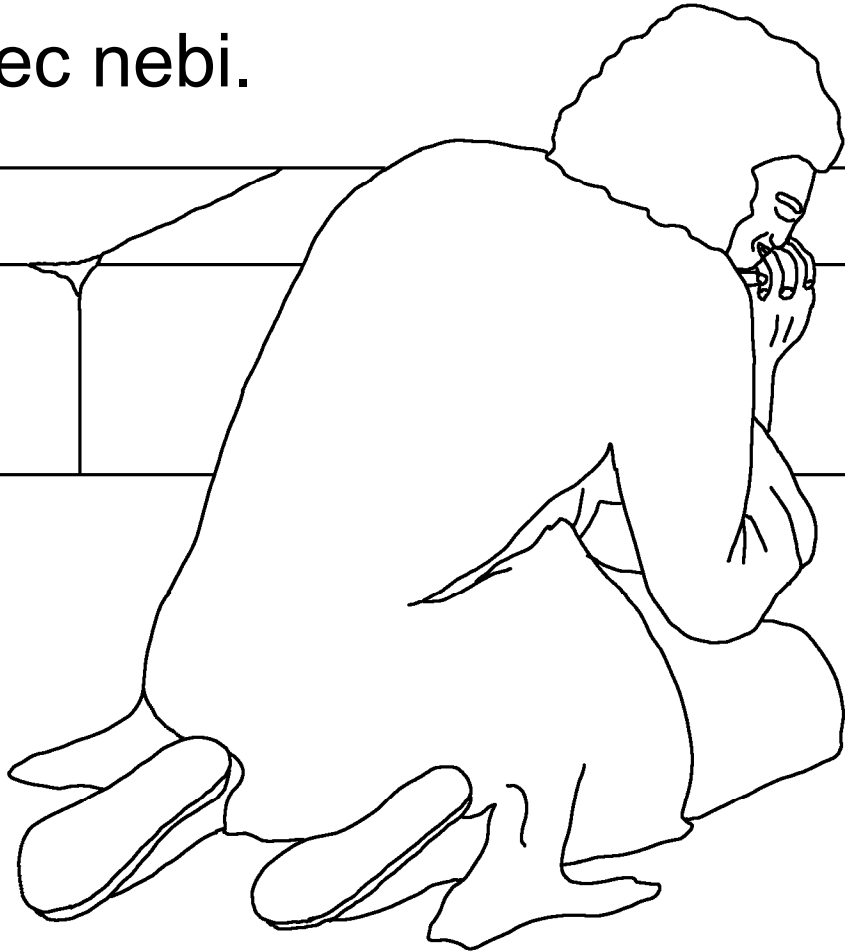

Adoac Nuquin Papan Mayanën buanshun ismiac
ushquin isacbimbuen ispombi. Adshun isaquien
aton tsadte dapanquio tsudain tsadposh.

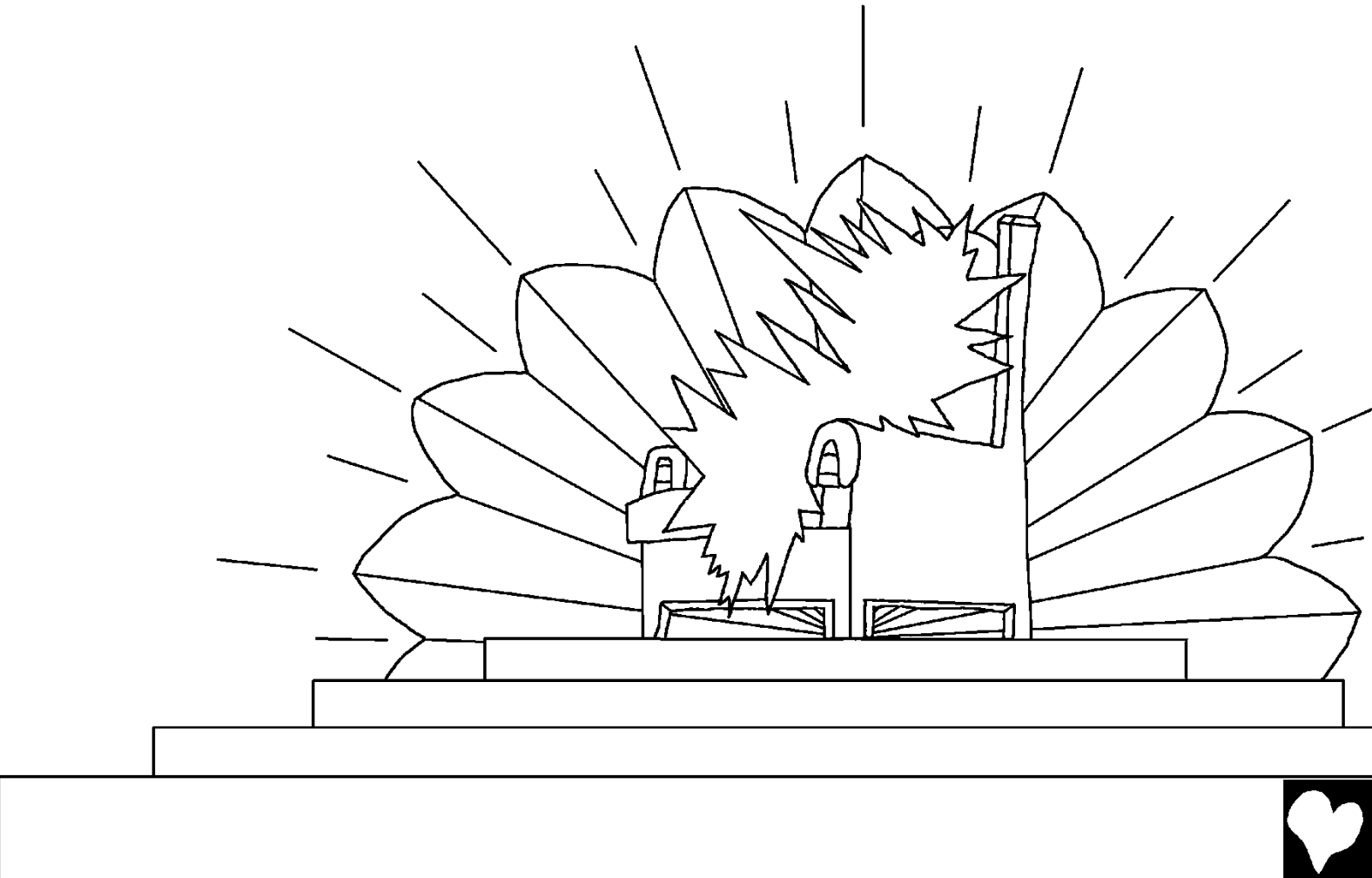

Adnubien Nuquin Papan uaido abitedimbo
cuëdëndoposh. Abi yacnocquidotedi yec
nidaidën icquidotedi yec uënësaid
uincuenmiaidotedi yec acten
icquidotedi yec quec cumapenec
cuëdëncuededposh naden
chiec: . . .

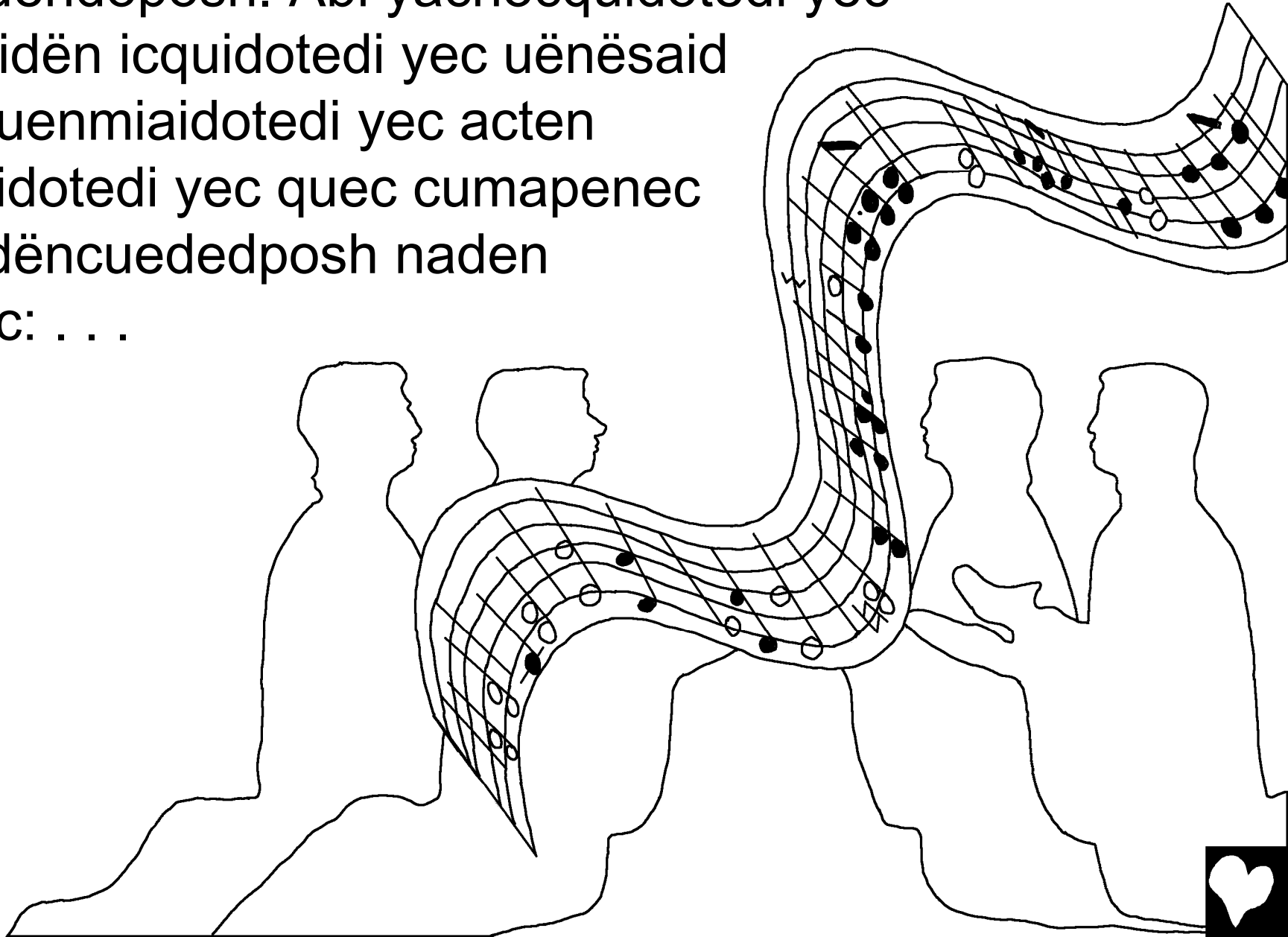

. . . Abitedishun Icbombo yec aton tsadte dapan
Nuquin Papaböd tsadquid Obecabimbuecquid
bödamboshë iquec. Aidi abided
cuidadec uënäsaid bödamboshë
iquec, canuna ënenquio icquin.
Aiduidtsëqui Nuquin Icbombo
nec. Utsi adquid nibëdec.
Aidën nac
nuqui
bödamboshë
iquec.

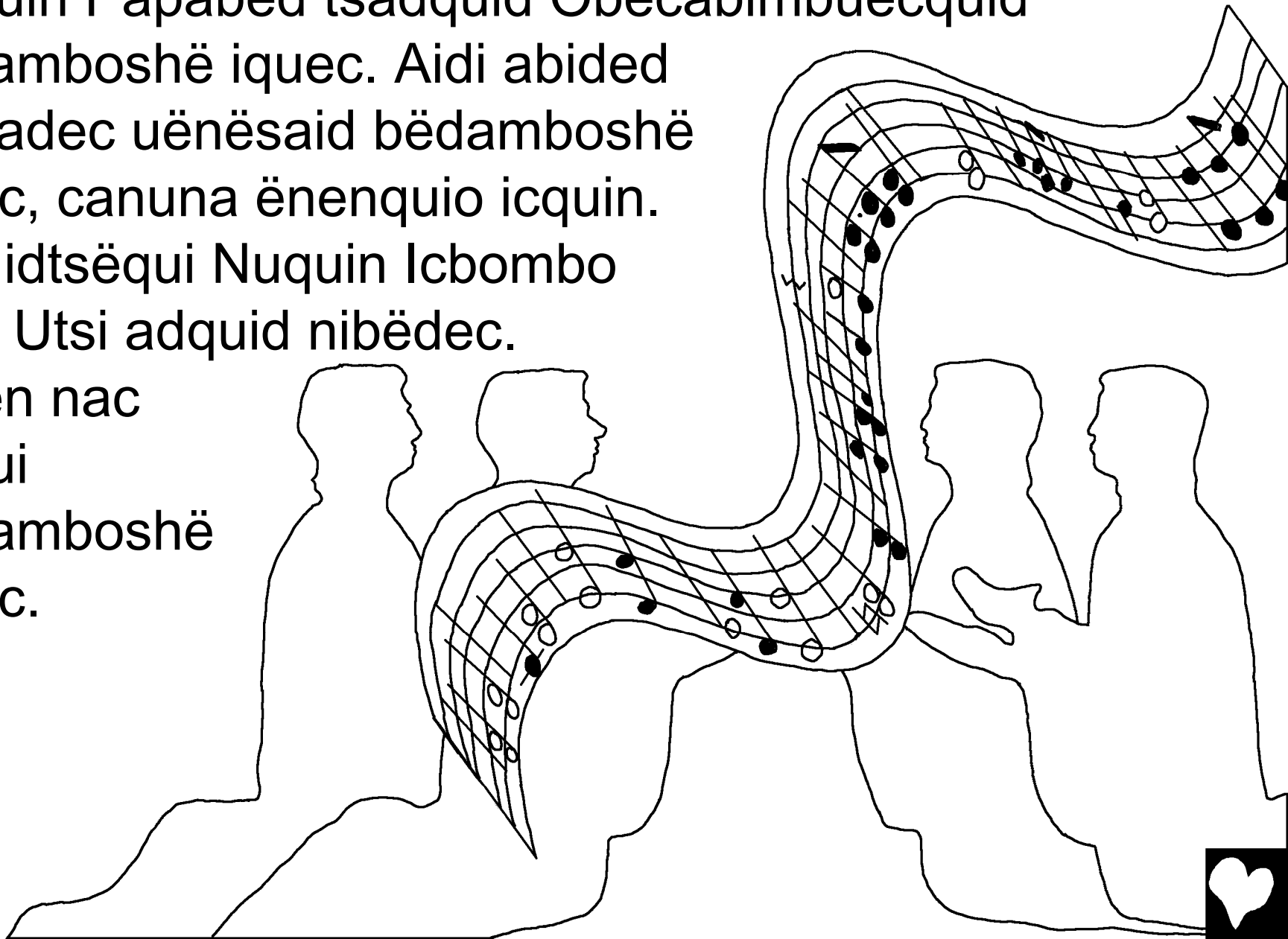

Aidpadquid nadatiambocquid utsi nibëdec,
canuna ënenquio icquin, quec abitedimbo
cuëdëncuededposh.

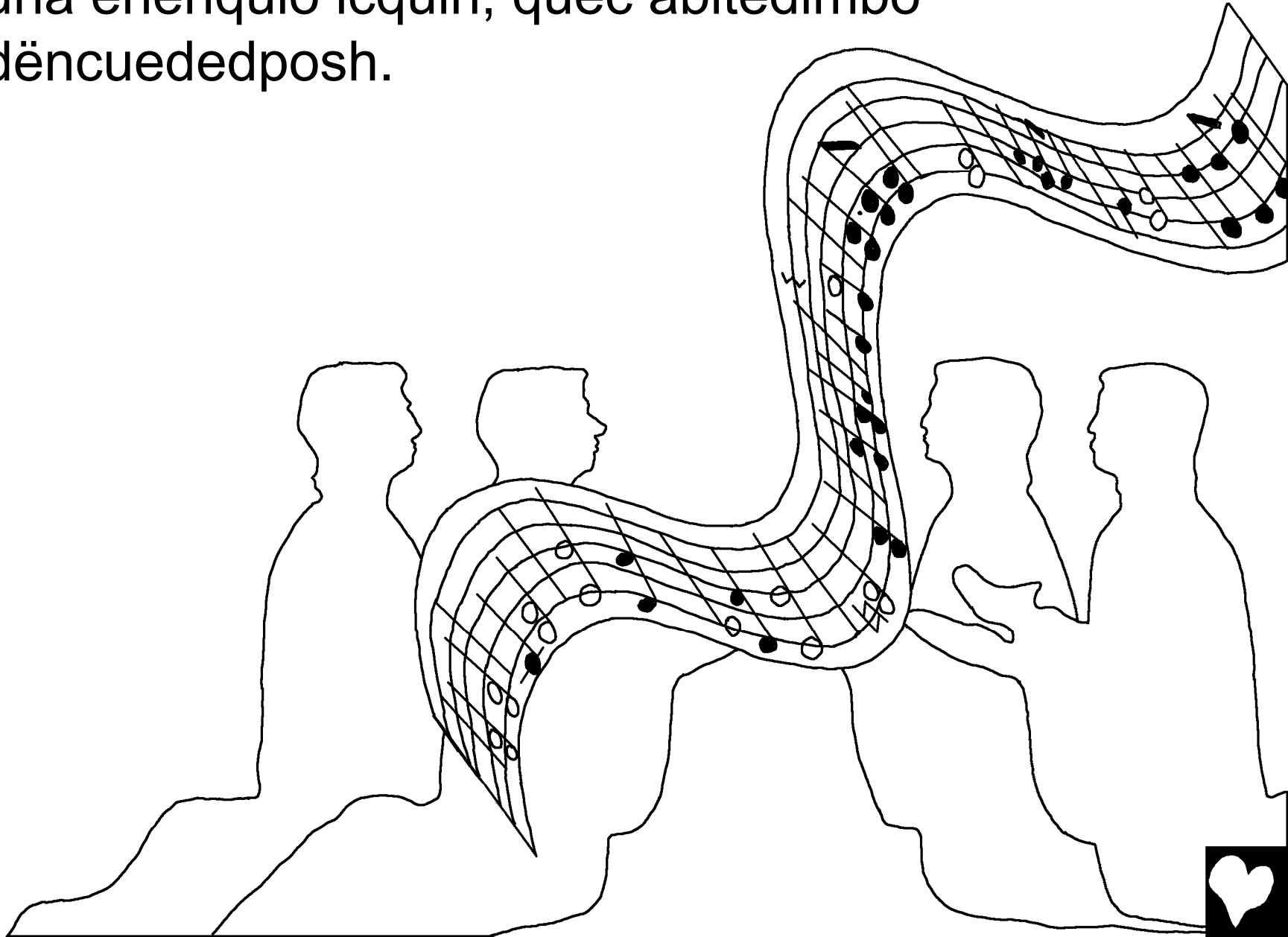

Adnubien bēdamboshē isadquid shubu dadpen icquid
Edusaden chuca caid Nuquin Papa yacnoësh
abucuësh budsho ispombi. Aidi chidon: Ma ubi bednu,
quequid dada bedmequin cuishoncamiacbimbuec
bēdamboshē isadposh.

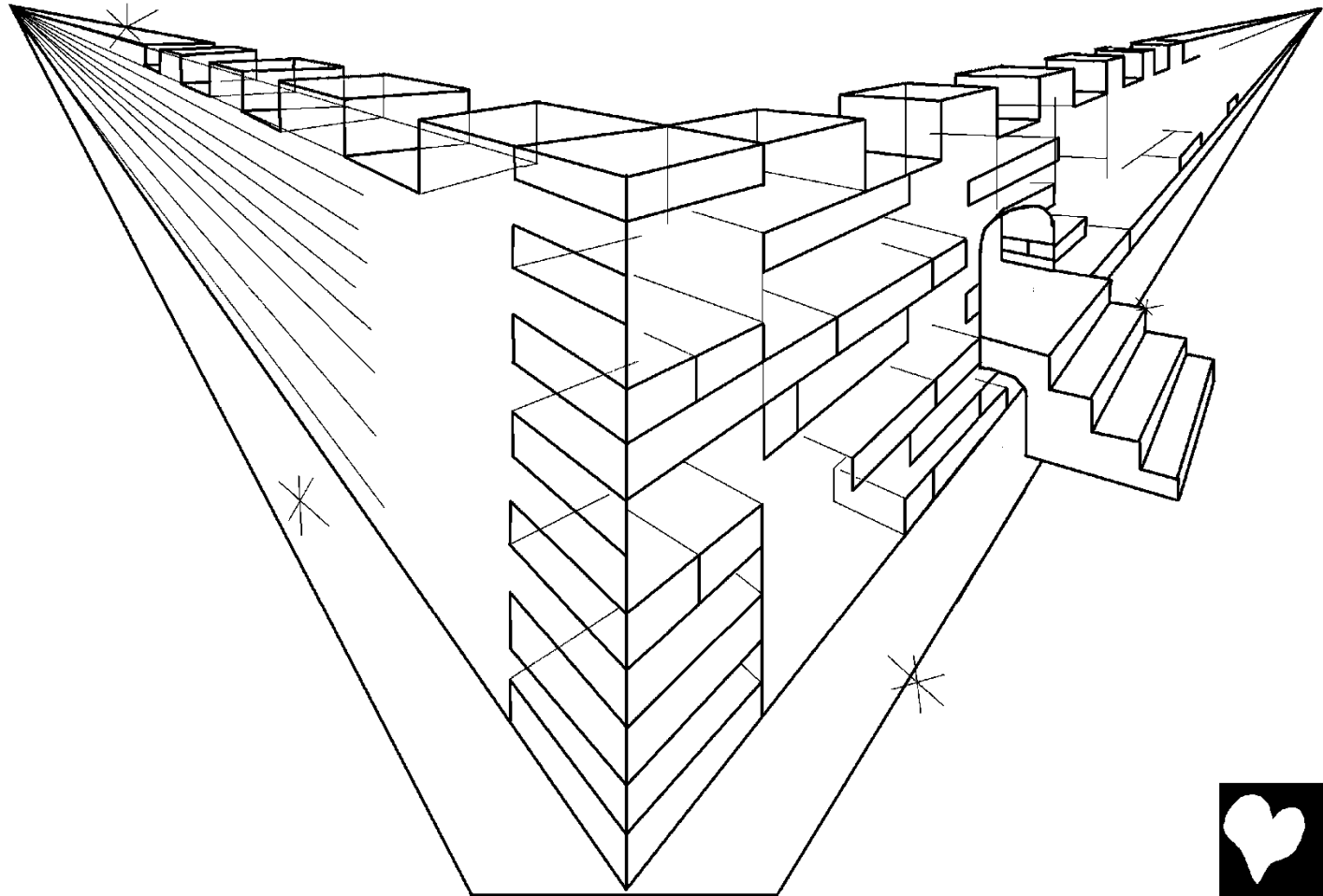

Adnubien aton tsadte dapan tsadacnouëshquio
cumapenec naden chiec onquesho tantiapombi: Cun
matses nec, quiash nēmbo aidobēd cuëshēdenquio
yec Nuquin Papa tabadendac. Adsho issun aton iuabo
icquin abitedishun: Nuquin Papauidtsēqui nuqui
tantiaidquio
icscho aid
Nuquin Papa
caindac.

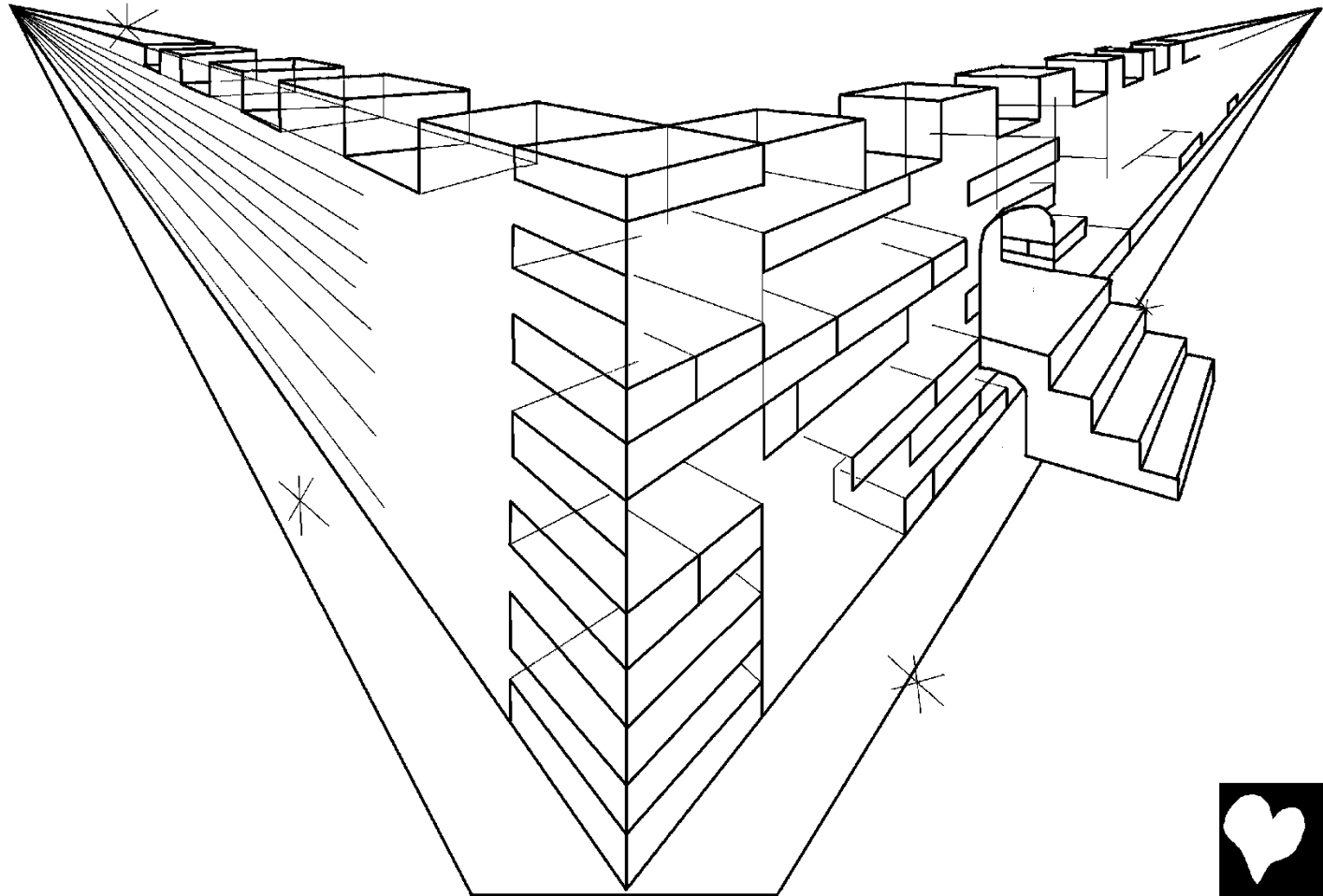

Aden ismeboshombic Nuquin Papaböd icquidän
padpiden ismeuaposhi. Adoac acte Nuquin Papaböd
tabadmetequid uënësenquio icmetequid icposh. Acte
bödambocquid acte actectsëcquio isadquid nushan
nibödquidquio chëuödsho ispombi. Aidi Nuquin
Papaböd Obecabimbuecquid tsadte dapan
tabadacnouëshquio choec chëuödposh.

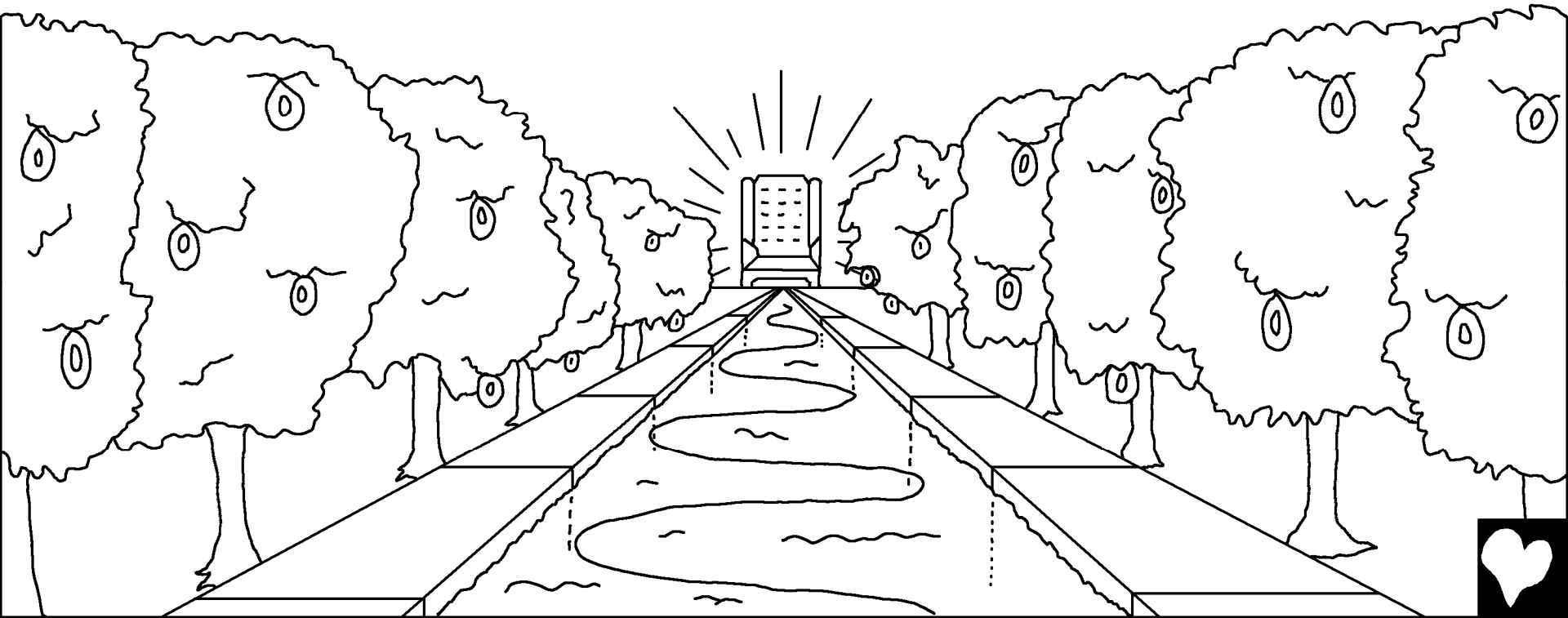

Ambobidi inchështanec badiadenquoio iquendac.
Badiadën uëshë isadenquoio iquendac. Inchëshën
uëshëtsen isadenquoio iquendac. Nuquin Papa
uëshëmbo yec bëchamauanquiec icquidëmbi ambo
uëshëmbouidquoio iquendac. Adecbidi
Obecabimbuecquid tabotebimbuec iquendac.

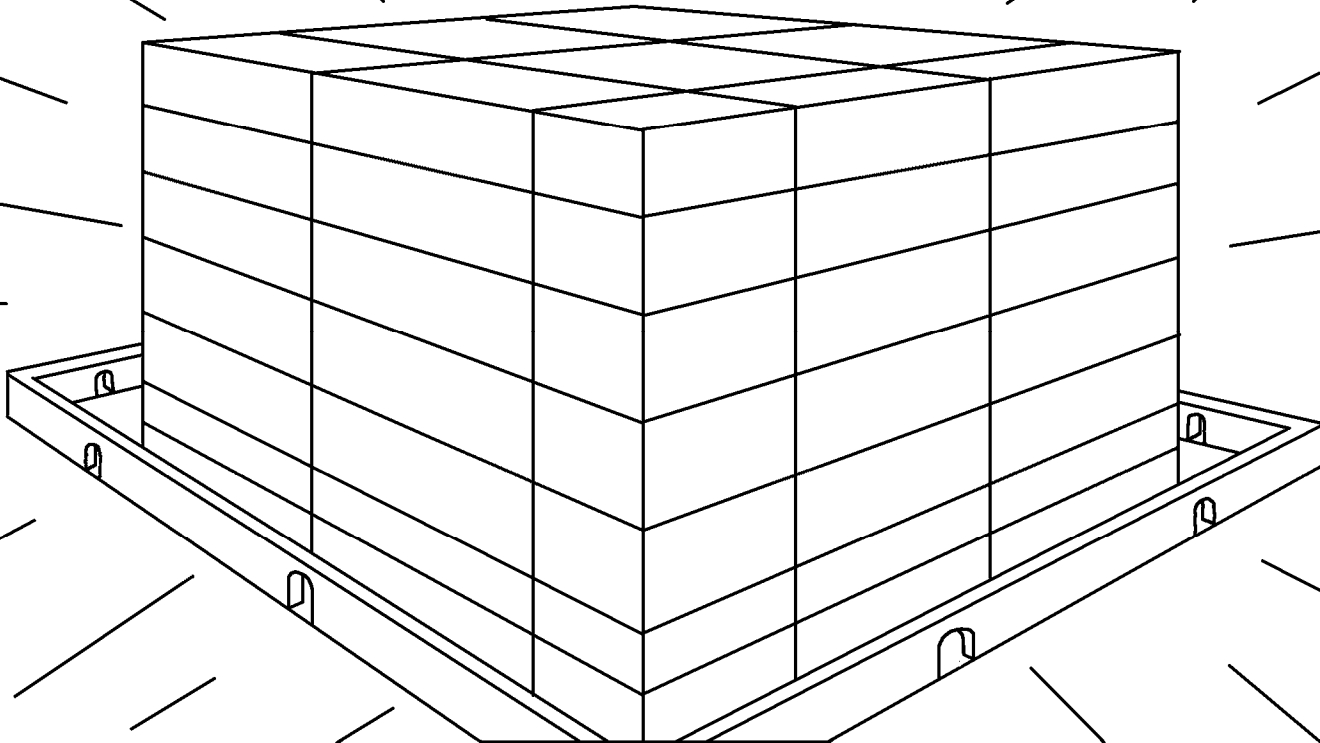

Ambo Nuquin Papan: Icsambuen naic, caido
puduedtiapimbo iquendac. Ambi papa canun
nacnenaid tantiaquido adecbidi
puduedtiapimbo iquec.

Obecabimbuecquid
tantiaquidoen
puduedendac. Aden
tantiaquid icsho: Cun
Pa yacno
tabadmetequid nëid
nec, queshun dadauate
dapan aton cuëmëdquid
dada uaidouidtsëqui ambo
puduedendac.

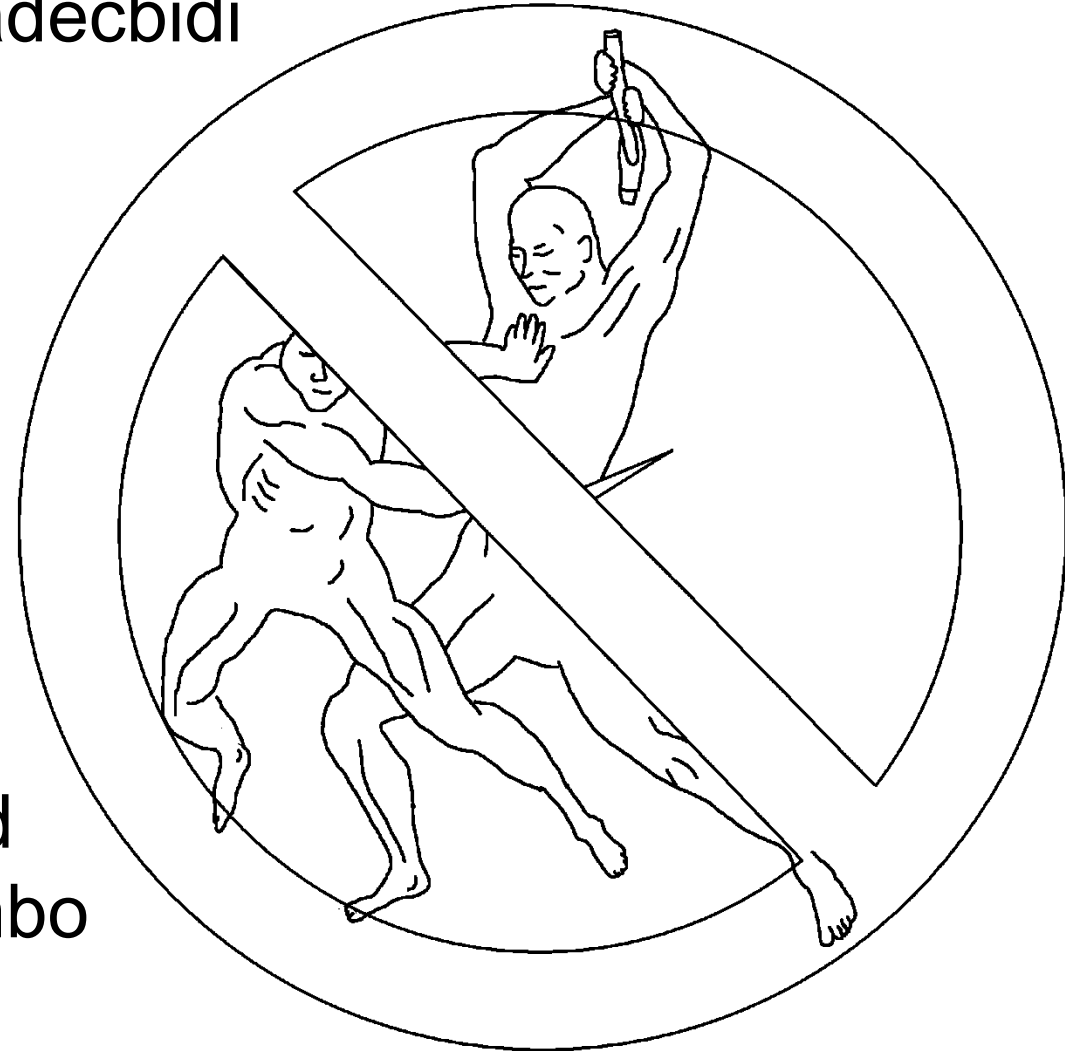

Nëmbo tabadec bëun
bëucacbimbuec matses
shubitiapimbo iquendac.
Nidaid shënin tabadec
abitedi uënëstequiduidquo
icbuedi nëuëshquo matses
uënëste nibëndendac.
Adecbidi sedenquec shubite
nibëndendac. Adecbidi
uënësquo icmiantequidbëd
paëmbo icte nibëndendac.
Adec ënden nidaidën
iccondaidtedi nibëdquo
iquendac, queposh.



Ambo cuidmete quid nibēdquio iquendac. Adquid
nibēdnuc shubu dadpen yacno aton tsadte dapan
tsadquid Nuquin Papabēta Obecabimbuecquid
tantiaquiec abi nashunquido tabadendac. Aido Nuquin
Papan abi cuēmēdquid
dada uaquin bēsiaido
yec Nuquin
Papambo bēisquiec
tabadendac.



Adshumbic uënësaidotedi aton matsesën
chuiquidobëd utsi chuiquidpenquo yec quec
Nuquin Papa aton tsadte dapan tsadsho bëisec
tabadposh. Adnubien dadauate dapan
dada uabanaid isquin Nuquin Papan
matsesën naidtedi abimbo
chuibamposh cuidnumbi.

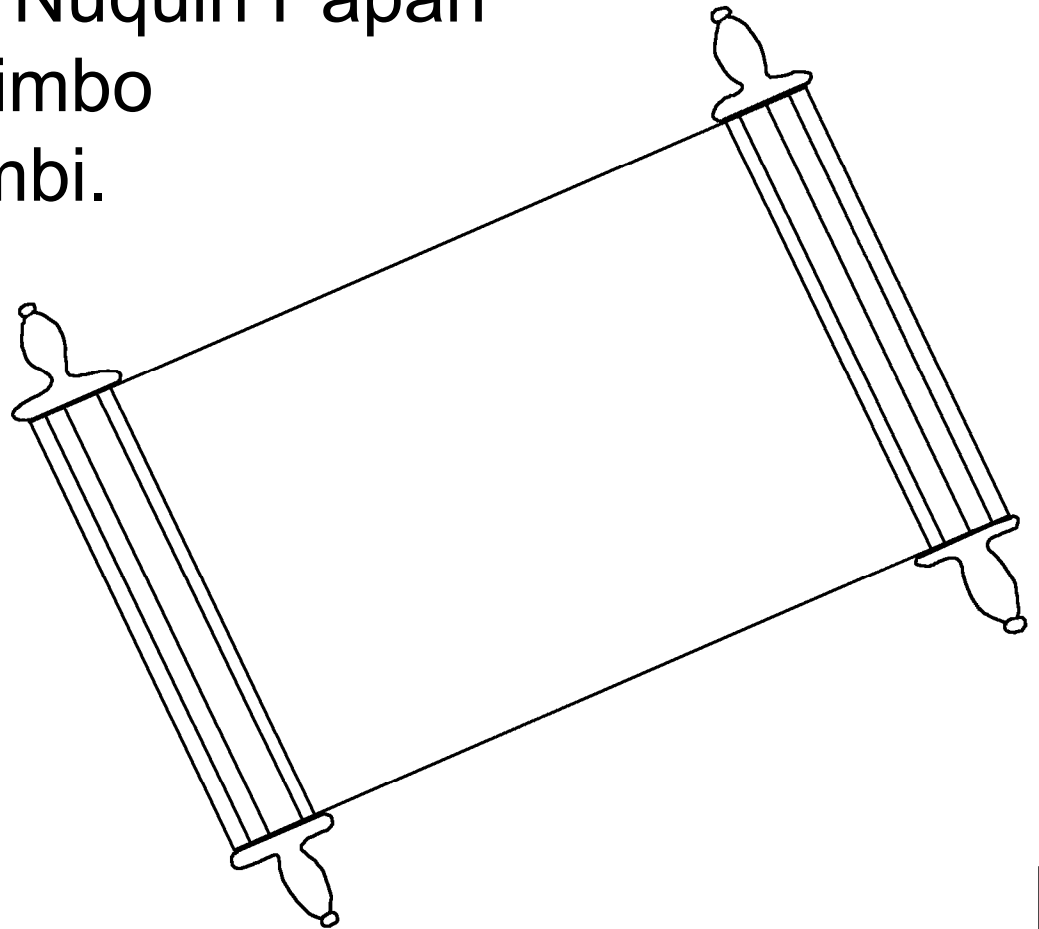

Adshumbic abi tantiaquido abëdi tabadmete dada
uaid tapa nec, caidën dada uabanaid isquin
chuibamposh abëdi tabadmenumbi. Ambobi
abi tantiesabo yec aton cuëmëdquid abëd
tabadmetequid dadauate dapan dada
uabicquid icsho Nuquin Papan
cuidquin nësecaposh.

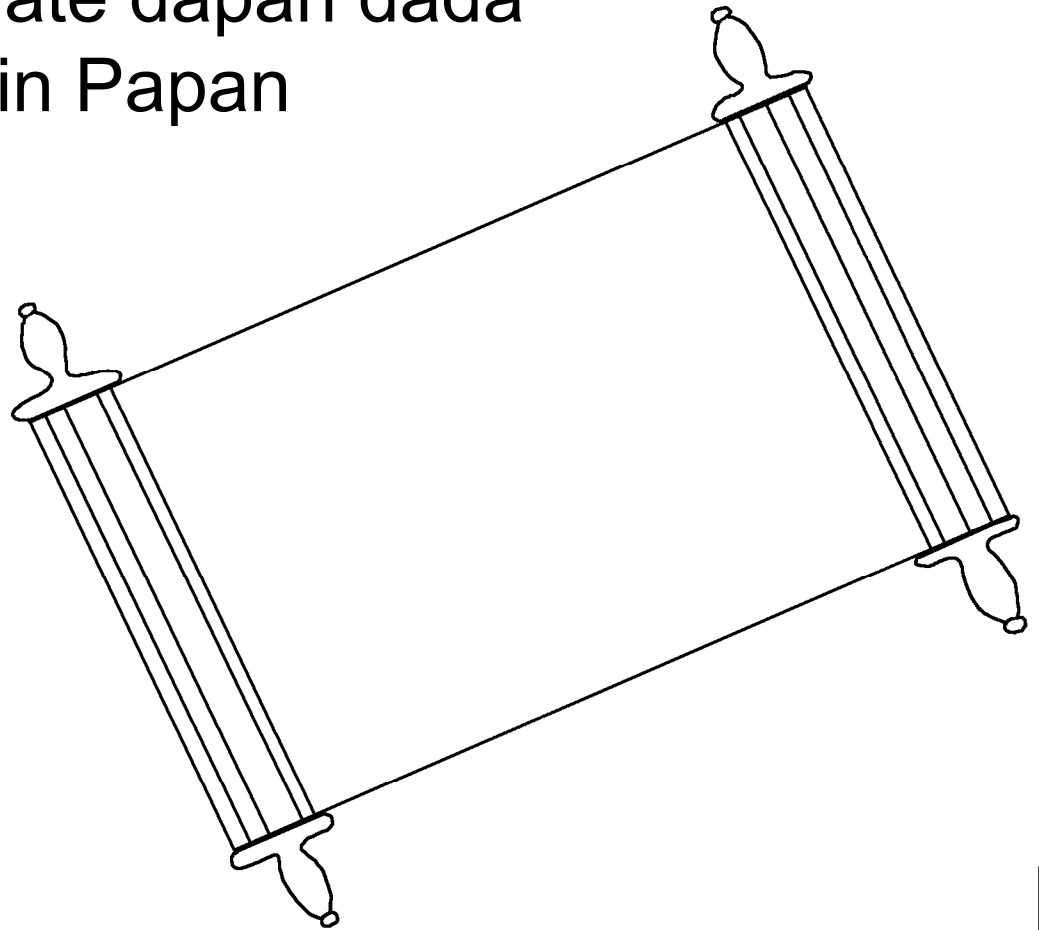

Adsho tantiashun Nuquin Papan Mayambëtan
Obecabimbuecquidën chidobimbuecquidën: Cho, cun
Icbo Esus, capec. Adembidi chuibansho Esus
tantiaquidotedishun: Cho, cun Icbo Esus, capec.

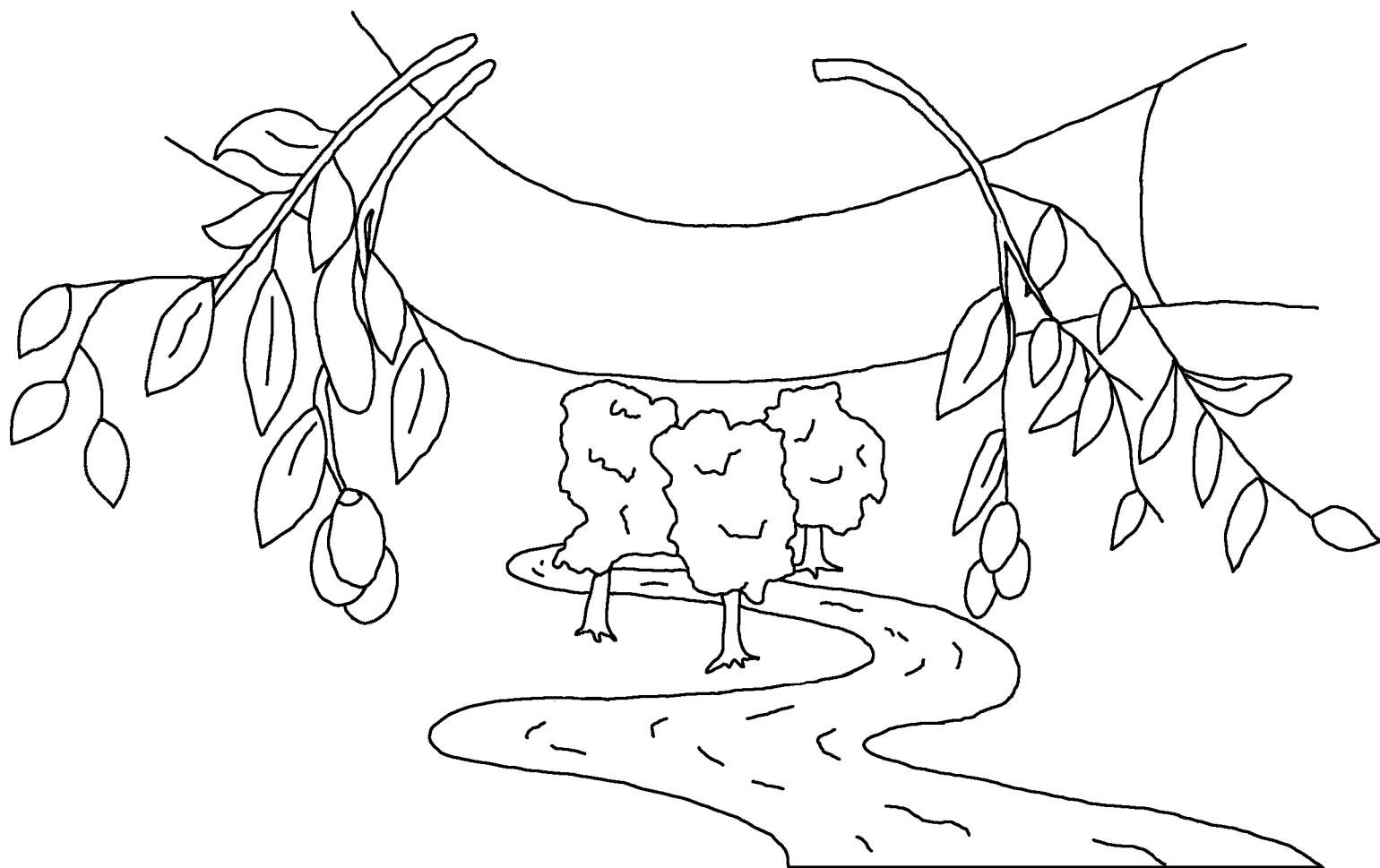

Adshumbic: Acte bundoash ubi acte acme, quesho:
Piucquid bec cho, quenquo icquin acte ushumbocquid
cushtoshon acmiacbimbuen ënëdenquo icnuc abëd
tabadmendac.

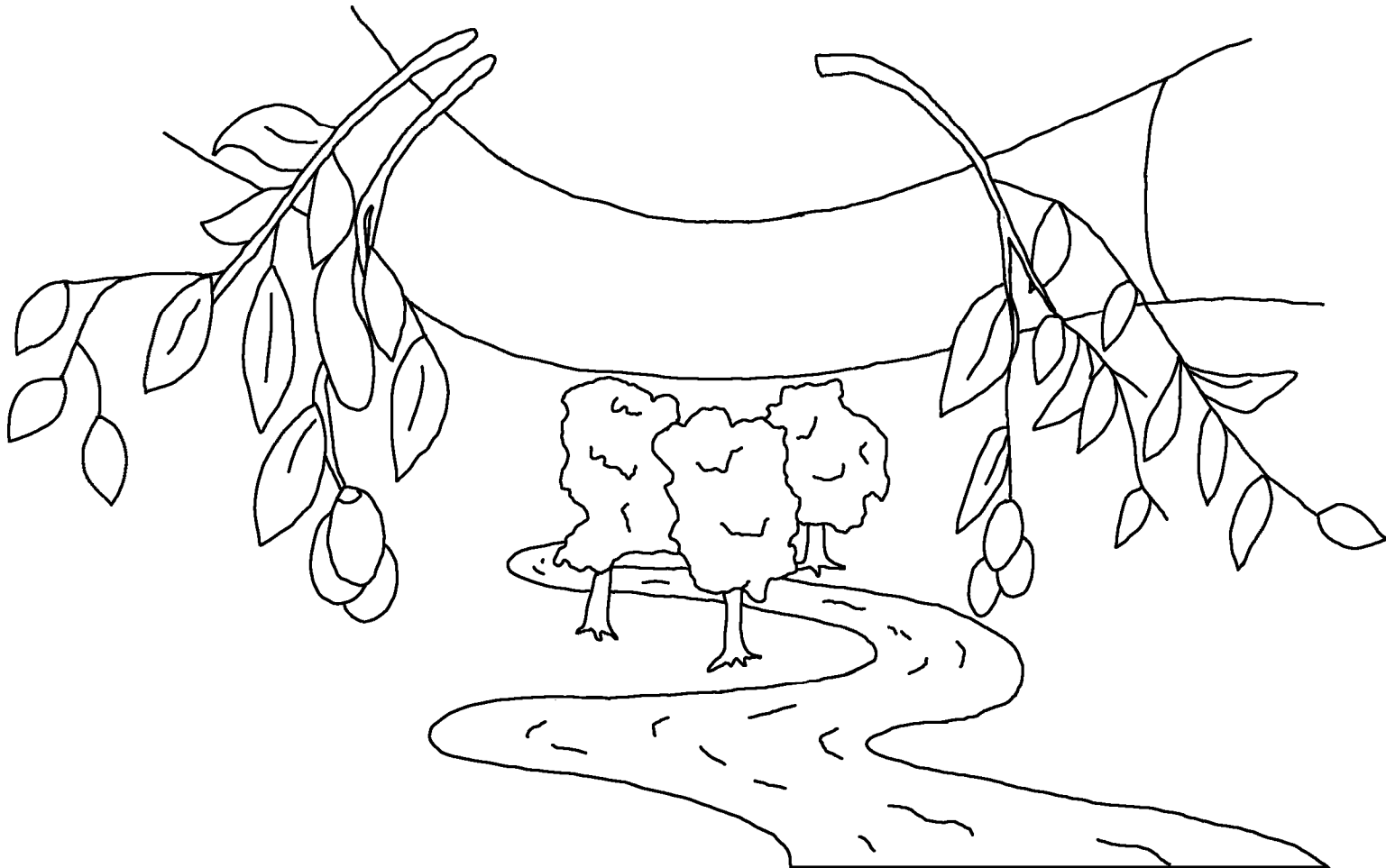

Adashic Esus: Matses abitedimbo
tantiaquidquo icquin Nuquin Papan aton
Mado abentsëqui abided cuidmequin
uënës uasho ubi tantiaquid
cuidenquiocquin abi yacno
ubëd ënëdenquiocnoc
tabadmendac.



Doma 3:23

Matses abitedi icsambuen naquido yec Nuquin Papa bēdamboshēcquidbēd ictiapimbo yec uannombo iquec.

Doma 6:23

Icsambuen naic tabadec uēnēsacsho Nuquin Papan ēnenquo icquin cuidacno nēsecaindac. Padnuen Nuquin Icbo Esuquidistubēd abentsēc yacbimbuec tabadquid icsho Nuquin Papan ēnenquiocquin abēdi tabadmendac.

Ebedeo 9:27

Adecbidi nidaidēn tabadquidtedi uēnēste uēshē abentsēc iquendac. Uēnēsacsho uincuemiac matsesēn ambi naidtedi chuisho Nuquin Papan tantiendac. Adshumbic Esus tantiaquido cuidenquiocquimbi abi tantiesabo cuidendac.



Epeso 2:8,9

Nuquin Papa matses bēdambuen iste bunquid icquin
Esuquidistu tantiasho abi yacno tabadtequido mibitedi
icmiac. Umbibi tantiacpaden naquin Nuquin Papa
bēdambuen ismembi, quetiapimbo mibitedi iquec.
Padnuen mibi tantiaquioquin: Ubi cuidquin mene,
quenquiocquin Nuquin Papan abi tantiamiaido mibitedi
nec. Matses iquec abi bunacpadombuen naic: Umbimbo
bēdambuen nabanquin Nuquin Papa bēdambuen
ismembi, quetiapimbo matses abitedi iquec.



Doma 10:9,10

Nuquin Papan uincuenmenëdaid Esus nec, quequin tantiaquin: Esus Cun Icbo nec, quequin abimbo chuisho Nuquin Papan mibi bëdambuen isquin abi yacno tabadmendac. Nuquin Papa tantiembi, quequin bëdambuen tantiasho icsaisabimbuecnuc bëdambuen isendac. Adembidi: Esus Cun Icbo nec, quequin tantiaquin chuisho abi yacno tabadmendac.

Uan 3:16,17

Adashic Esus: Matses abitedimbo tantiaquidquo icquin Nuquin Papan aton Mado abentsëqui abided cuidmequin uënës uasho ubi tantiaquid cuidenquiocquin abi yacno ubëd ënëdenquiocnoc tabadmendac. ¿Matses cuidnuenda Nuquin Papan aton Mado chomepanëdash? Padenquo. Aton Mado tantiasho matses cuidenquo icquin abëdi tabadmenuen chomepanëdash.



Uan 1 5:11-13

Nuquin Papan Chiaid nad iquec: Cun mado tantiaquido
ënëdenquio yec ubëd tabadtequido iquendac, quequin
chiaid iquec. Adec aton Mado Esus tantiaquido ënëdenquio
yec aibbëd tabadtequido nendac. Esus tantiesaboen
Nuquin Papabëd tabadtequidpenquio nendac. Nuquin
Papan Mado Esuquidistu nec, quequin tantiaquid
Icbobëd ënëdenquio yec tabadtequid nendac, quequin
tantiaquidquio ma mibitedi icpanu, quequin
chuiquin dada uaic nebi.



Uan 14; 5 Codinto 2; Esusën Uan ismiaid, 21, 22

Storyline by: Edward D. Hughes

Illustrated by: Lazarus
and Alastair Paterson

Adapted by: Sarah S.

Matsés NT (mcf) © 2023, Wycliffe Bible Translators, Inc.
All rights reserved.

<https://www.bible.com/bible/631/MAT.1.MCFNT>

©2026 Bible for Children, Inc.

www.M1914.org

www.bibleforchildren.org

