

www.BibleForChildren.org



San Juan 14



—Pues te'i. Jetz'a'anaque'ex a wool. Que'ene'ex tun a wool tu pach a Dioso. Que'enaque'ex ilic a wool tin pach inene,— cu t'an a Jesusu. —Ichil u yotoch in Tat ti ca'ana, yan ti yaab tuba u cuntal a maca. Wa cuchi ma' baalo' ti yana, ma' cuchi tan in wadic te'ex ti yan.

Bel in ca'a in wutzquinte'ex a cuuchil,— cu t'an a Jesusu.

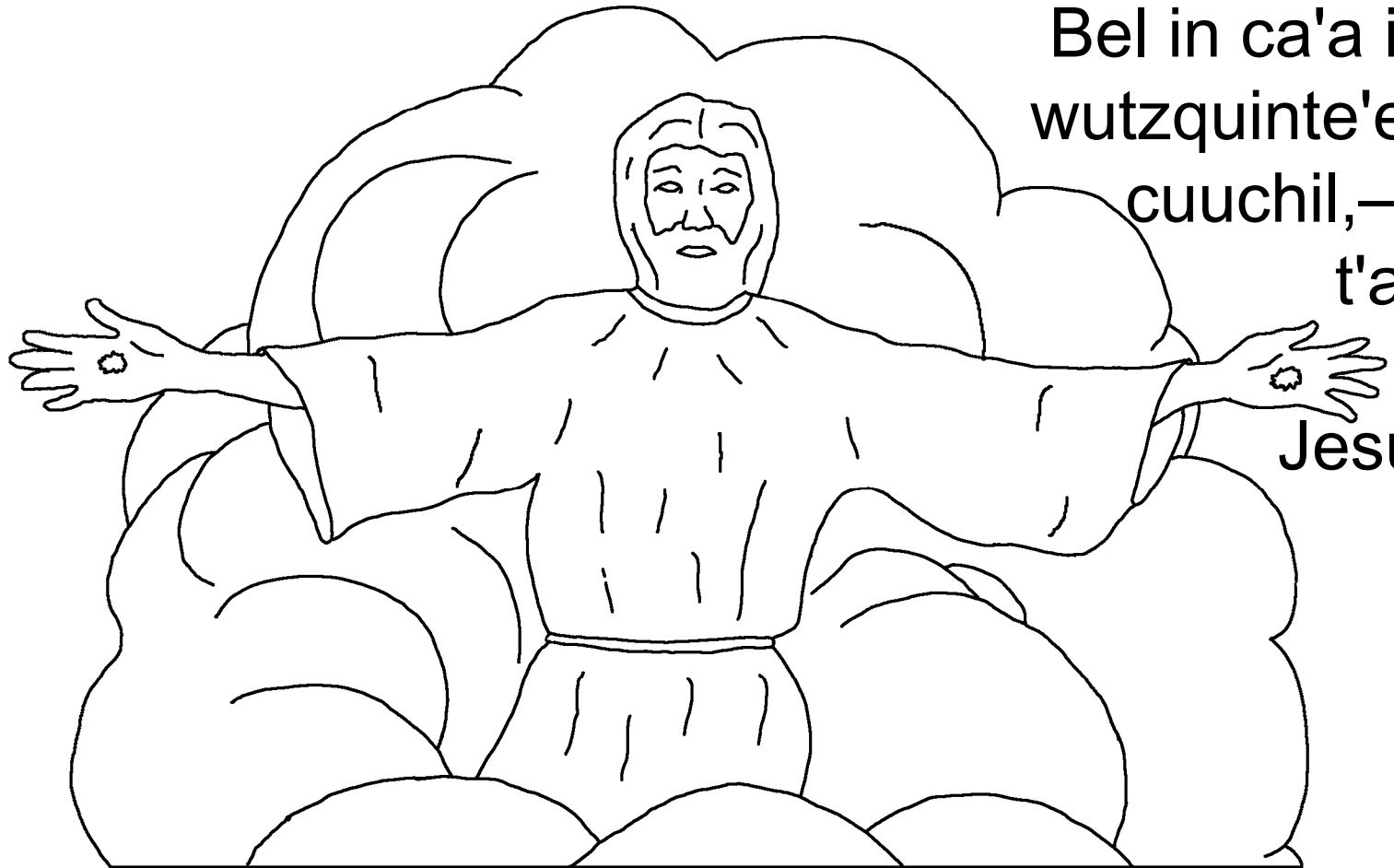

—Le'ec ca' xiquen in wutzquinte'ex a cuuchili, ca' wataquen in ch'a'e'ex. Ti baalo'o, le'ec tuba que'enene, te'i ilic a beele'ex,— cu t'an a Jesusu.



Pues te'i. Inene, aj Juanen. Hermanojen jabixe'ex
iliqui. Walac in c'ümic a yaj jabixe'ex iliqui, u
men ti'ijo'on a Jesucristojo. Que'enen

tu c'ü' jabixe'ex iliqui.

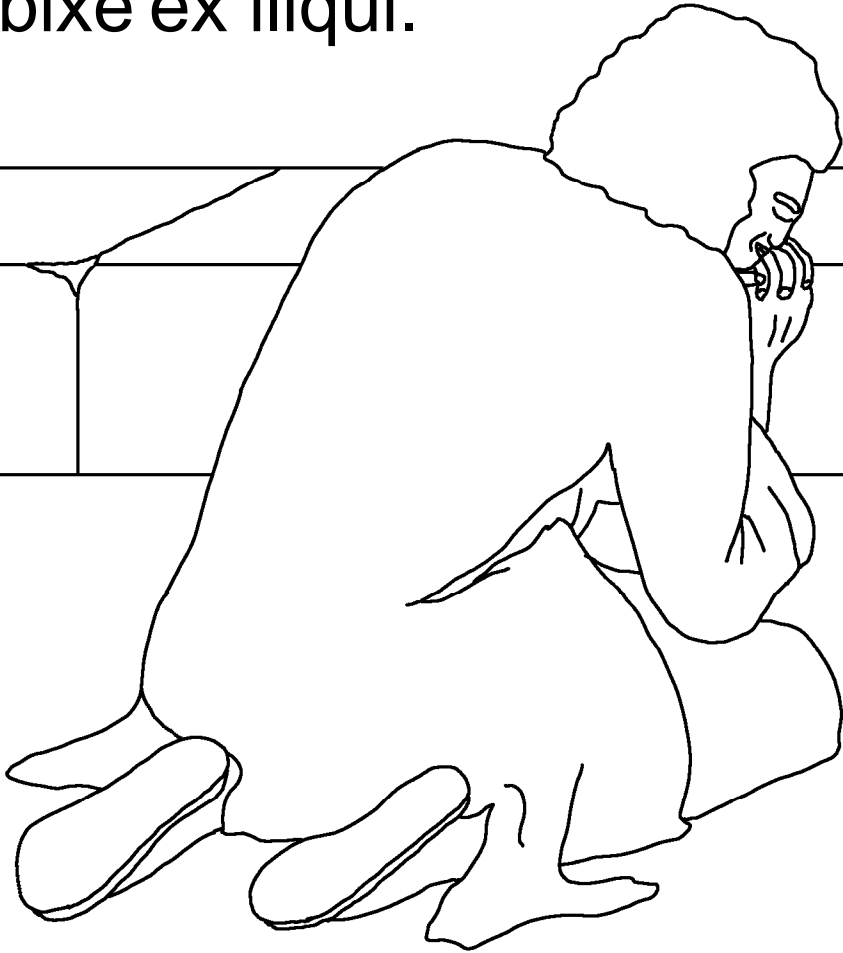

Walac in muc'yajtic a yaj abe' jabixe'ex iliqui.
Yoc'lal u t'an a Dios y u pectzil a Jesucristo
a walac in wadiqui, p'ütbeen tuwich jun

p'eel lu'um Patmos u c'aba'.
Xooya'an ti c'ac'naab a

lu'um abe'e.



Tu seebal tan in wu'yic ti mas que'en u Püsüc'al a Dios tin wetel. Ca' in wilaja, te'i que'en a jabix u silla a rey ich ca'an. Tina'an ti que'en a Dios tuwichi.

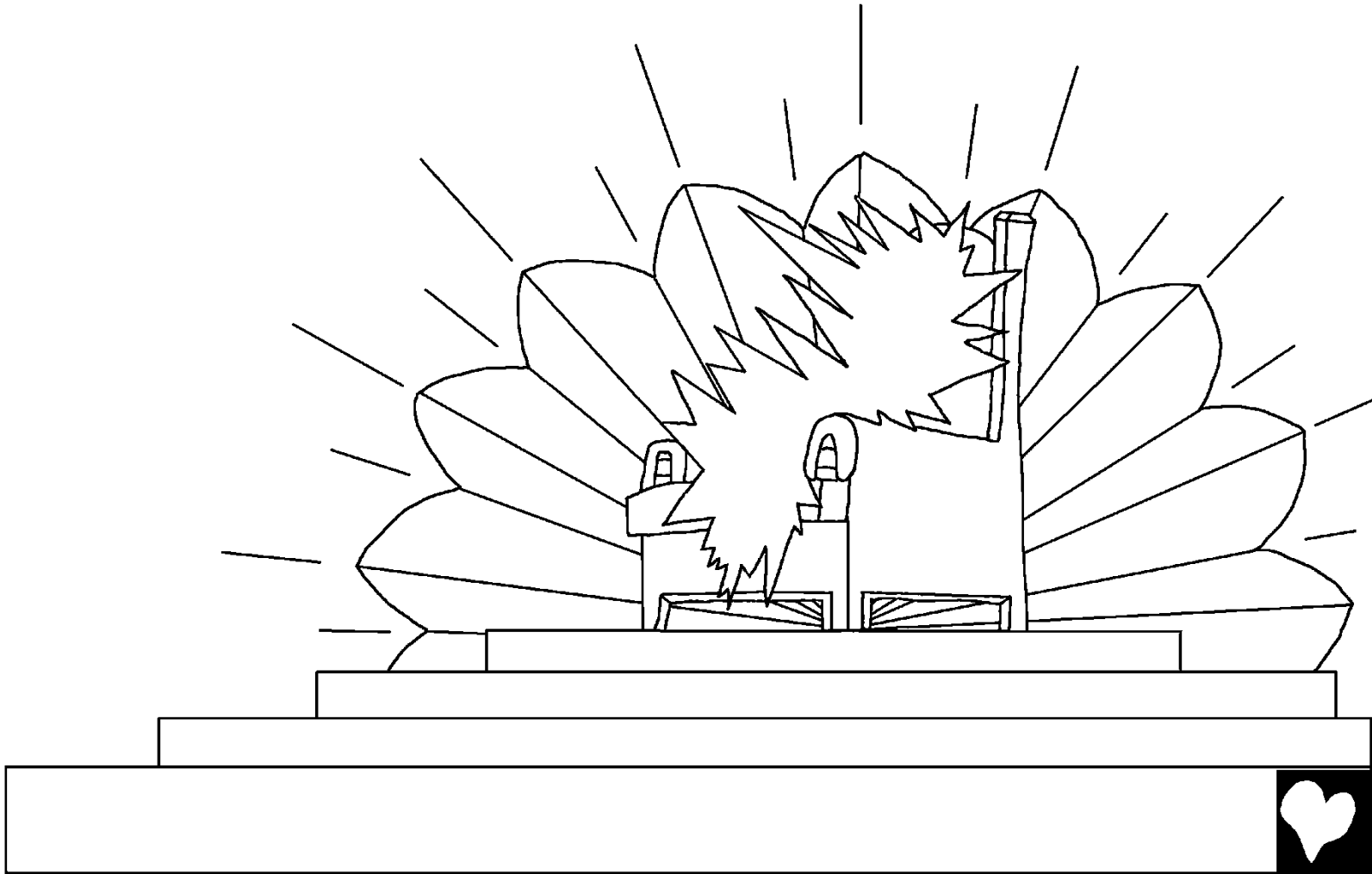

Pues te'i. In wu'yajoo' ilic u t'an tulacal a c'u' a betabi
ichil a ca'ana, tuwich a lu'umu, yalam a lu'umu, ichil a
c'ac'naaba, tulacal. —Le'ec a Dios
a tina'an tuwich silla chumuquil u
yet'oc a Carnerojo, qui' u
yaalbüloo' u qui'il. Qui' u
tz'ocsabüloo' u yanil. Qui' ti yanoo'
u muc' ti tücaa'.
Qui' u yaalbül
abe' jumpul,—
cu t'anoo'
tulacal abe' a
c'u' a betabiji.

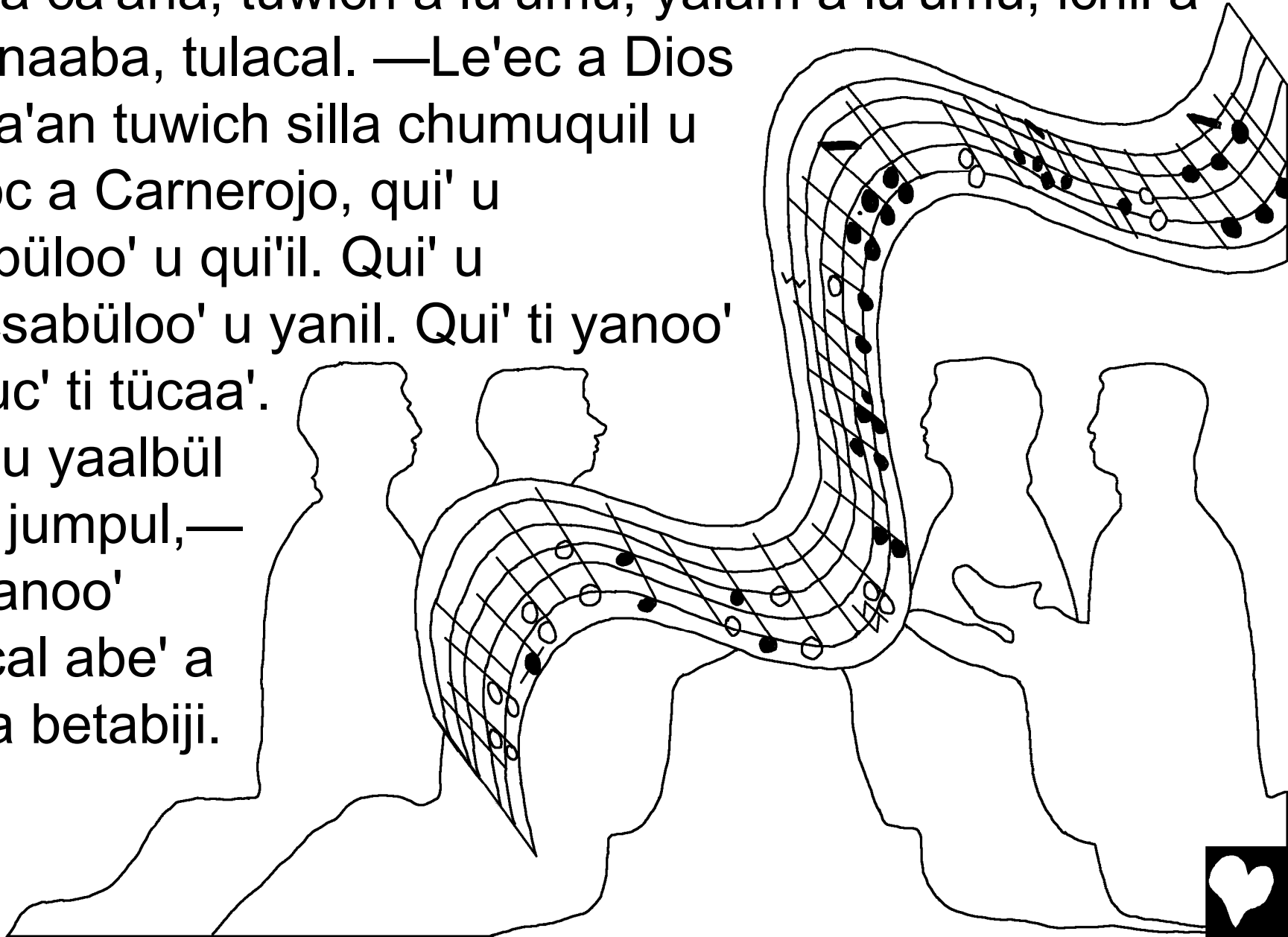

In wilaj ilic a caj a ti'i a Dioso, le'ec a Jerusalen a tumulbene. Tali ti ca'an etel a Dioso. Tan u yemel yoc'olcab. Qui' utzquinaja'an jabix ilic ti utzquinaja'an jun tuul ix chu' ti'i u beel ti tz'ocolbeelee. In wu'yaj ilic jun p'eel a t'an a chich u peec a tali tuba tina'an a Dioso.

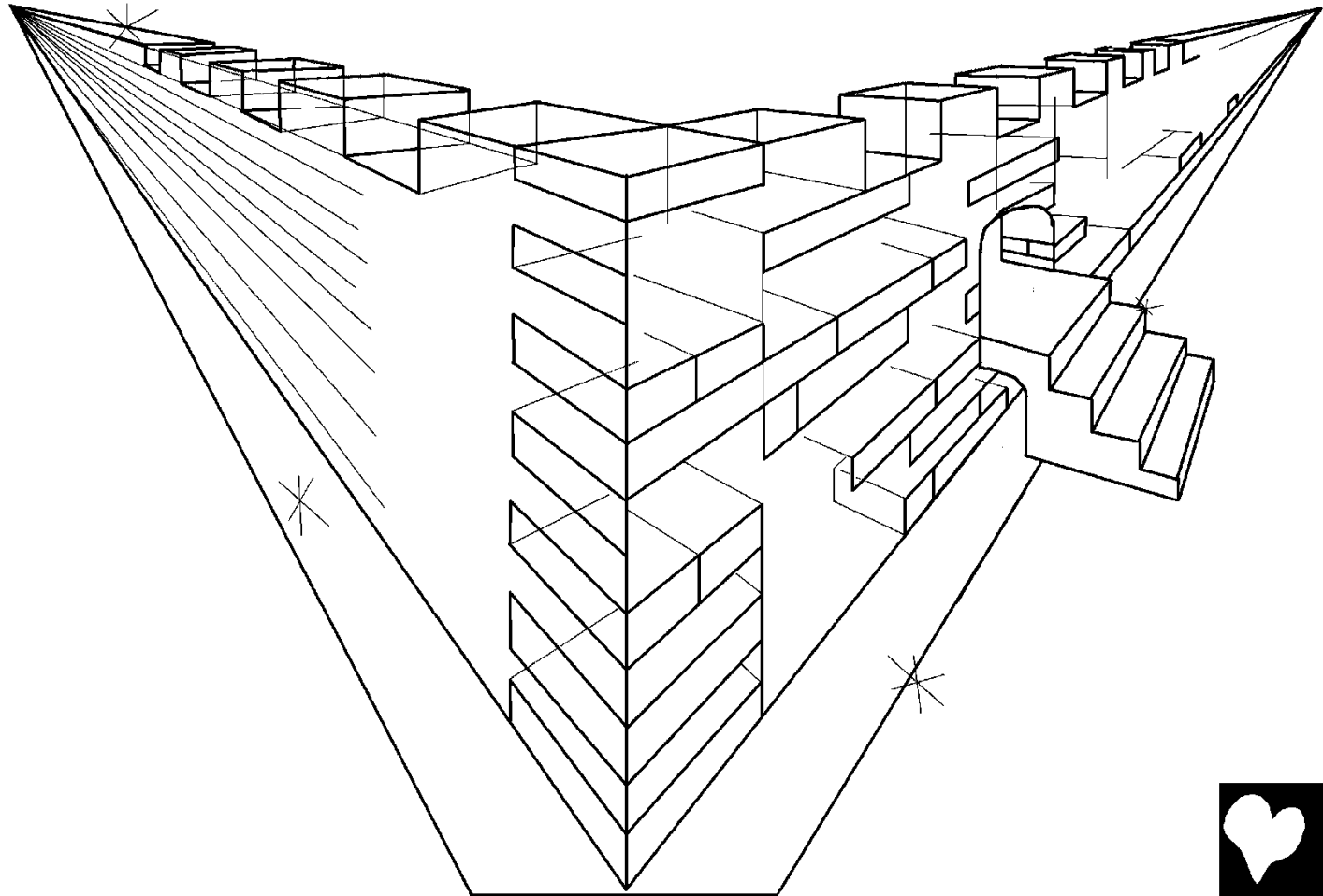

—U'yeene'ex. Le'ec u yotoch a Dioso, que'en tu yaamoo' a cristianojo,— cu t'an a t'an abe'e. —Bel u ca'a ti cuntal tu yaamoo'. Ala'oo'o, ti'ijoo' Dios. Le'ec ilic a Dioso, que'en tu yaamoo'. Ala'aji, u Diosoo',— cu t'an a t'an abe'e.

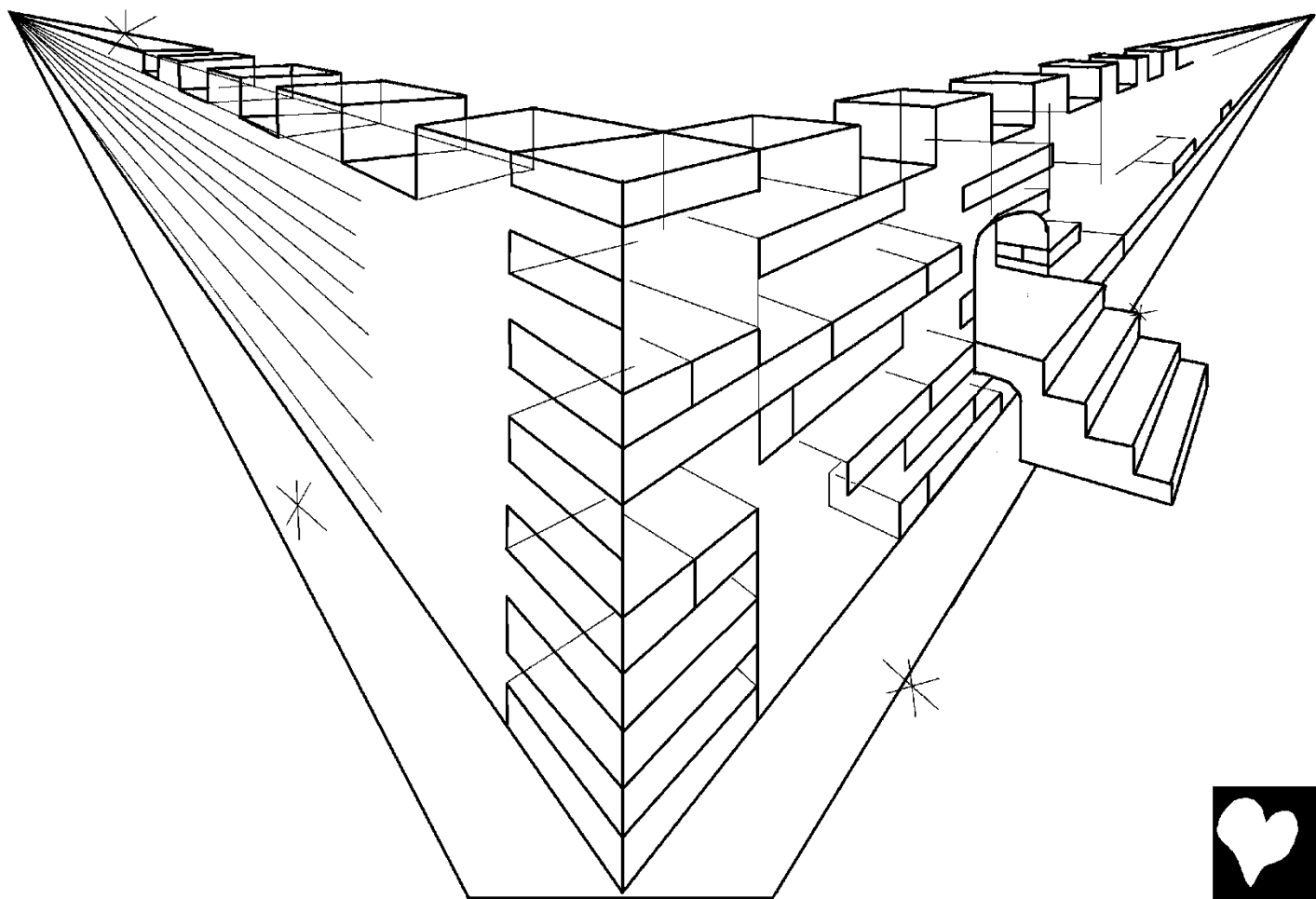

Pues te'i. Le'ec u yaj xa'num a Dios ti ca'ana, u ye'aj ten a noja' a que'en ichil a caja, le'ec a walac u tz'eec a cuxtala. Top chilam jabix neene. Tan u joc'ol tuba que'en a silla a ti'i a Dioso, y a ti'i a Carnero a que'en ichil a caj abe'e.



Ma' yan u c'abeetil a q'uin ma'ax a uj ti'i u tichical a caj
abe'e. Le'ec u sasilil a Dioso, le'ec tan u tz'eec u sasilil
a caja. Le'ec a Carnerojo, le'ec a c'aac' ti'i a caja.



Ma' yan a c'as a bel u
ca'a ti ocol te'iji. Ma' tu
yocoloo' te'i a walac u
betic c'u' a motztzil u
men a Dioso, ma'ax a
walacoo' u tusu. Jadi'
beloo' u ca'a ti ocol te'i
boon tuul a
tz'iiba'anoo' u c'aba'
ichil a ju'um a ti'i a
Carnerojo. Le'ec boon
tuul a yan ti'ijoo' a
cuxtal a ma' yan q'uin
u jobolo, tz'iiba'anoo' u
c'aba' te'i.



—Bel u cu laj choo' u c'a' u
wichoo' yoc'ol ca' qui'acoo' u
yool jumpul. Ma' ca' yan a
quimili, ma'ax a yaj-oolala, a
oc'olo, a yajili. Tulacal a jabix
abe'e, jobi,— cu t'an a t'an a
tali tuba tina'an a Dioso.



Ichil a caj abe'e, ma' ca' yan jumpul boon a yajil a tz'abi u men Dios jabix ca' u yaax cüxtajoo' u sip'il a cristiano tu cajeebe. Le'ec a silla a ti'i a Dioso, y a ti'i a Carnerojo, te'i que'en ichil a caj abe'e. Beloo' u ca'a c'ajsabül u menoo' u yaj meyaj. Beloo' u cu yila' u wich u yumil a sillaja. Que'en u c'aba' a Dios tu t'aboo'.



In wilajoo' a quimene. Ca'ax nucuch ca'ax mejen,
wa'an ti que'enuu' tu taan a sillaja. Jebbi boon a ju'um
tuba tz'iiba'an c'u' u betajoo' a jujun tuulu. Jebbi ulaac'
jun p'eel a ju'umu, le'ec a ju'um tuba tz'iiba'anoo' u
c'aba' a yan ti'ijoo' a cuxtal a ma' yan q'uin
u jobol. Le'ecoo' a quimene, tz'aboo' ichil
u sip'il jabix ilic ti tz'iiba'an ichil a
ju'um c'u' u betajoo'o.

Tulacal a jujun tuulu,
wa ma' cüxtabi u
c'aba' ichil a ju'um tuba
tz'iiba'an u c'aba' a yan
ti'i a cuxtala, pulbi ichil a
jabix laguna a chen c'aac'.

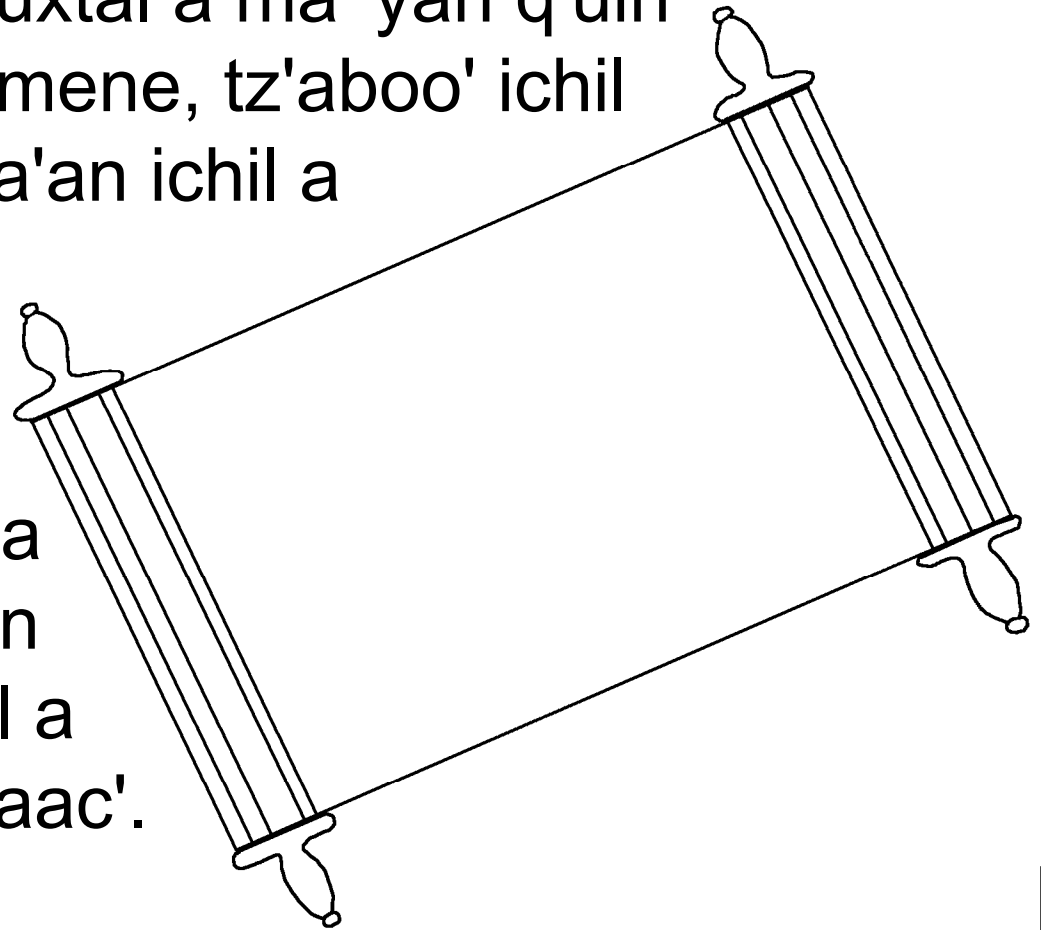

Pues te'i. Le'ec u Püsüc'al a Dioso, u yet'ocoo' a c'aata'an u men a Carnero ti'i u yütana, le'ecoo' a hermanojo, tanoo' u yadic ti'i a Jesus ca' uduc. Le'ec mac tan u yubic a t'an ada'a, tan cuchu u yadic ca' uduc.

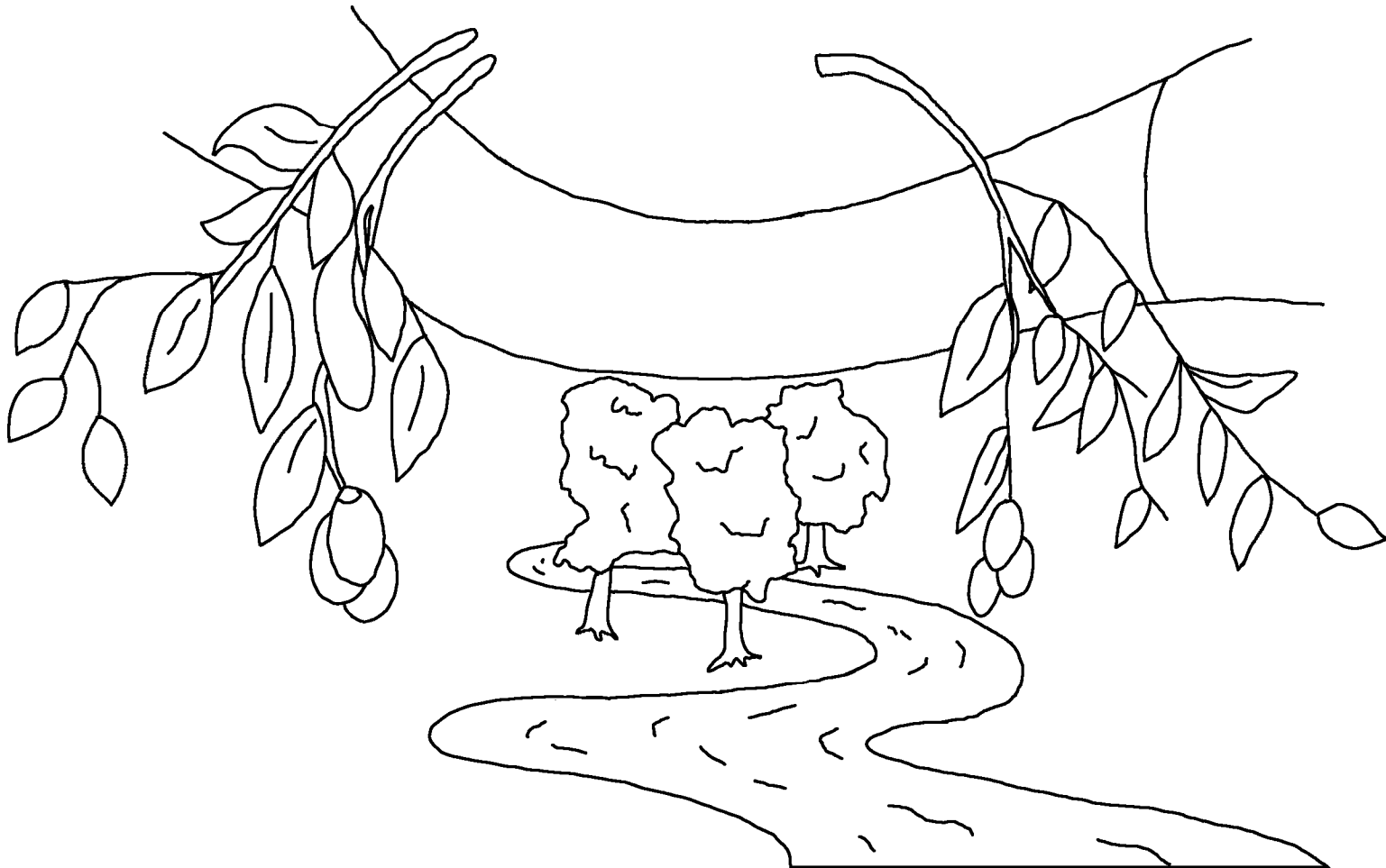

Le'ec mac a jabix uc'aj ti'i a Dioso, qui' u tz'eec u yool
tu pach jabix cuchi tan u c'ochol etel. Le'ec mac u c'ati
u yuc'u' a ja' a walac u tz'eec a cuxtala, u paatal u
yuq'uiqui. Ma'ax boon u tool.

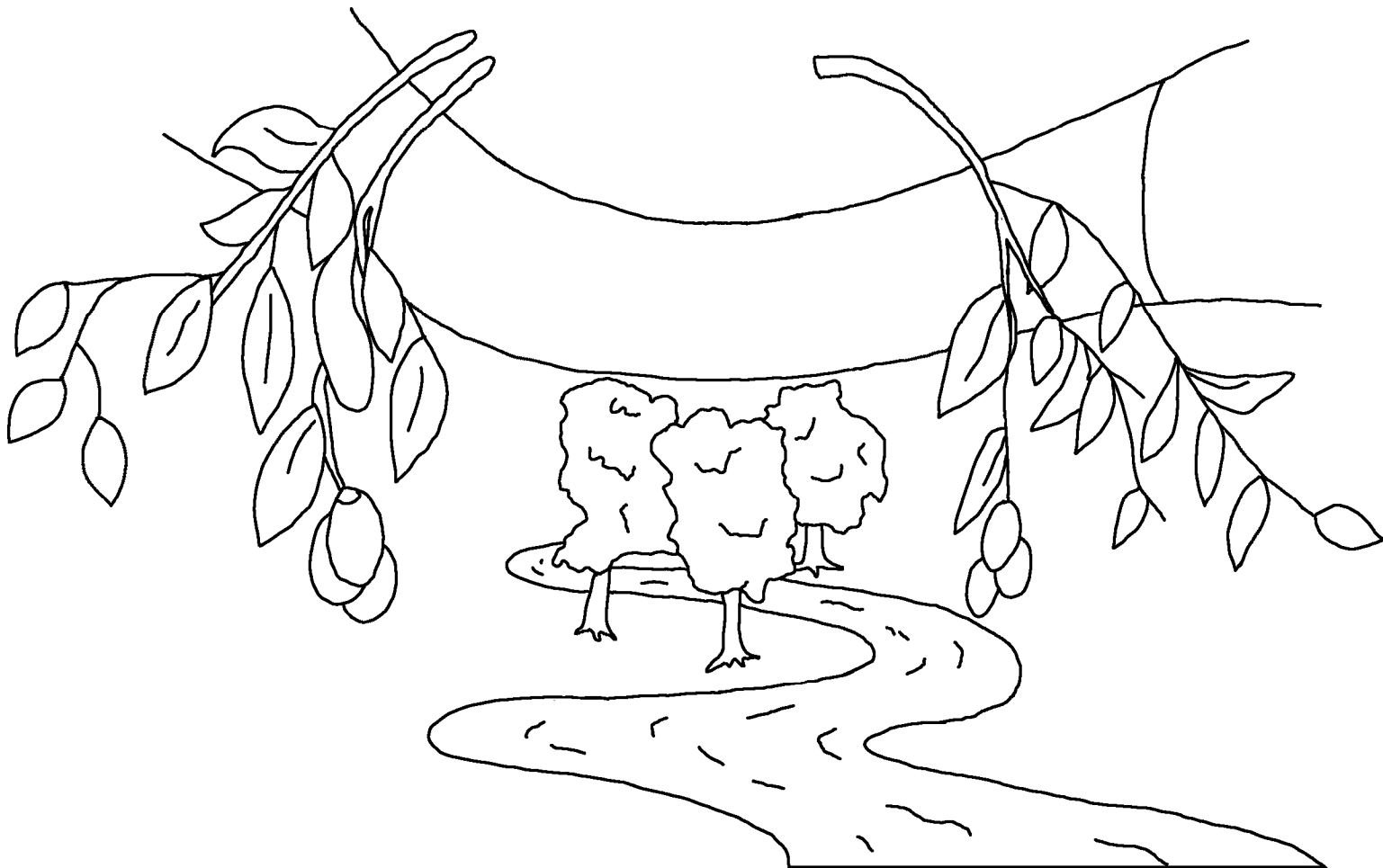

Pues te'i. A Dioso, top yaj u yuboo' a
cristiano yoc'olcaba, mentücü, u c'ubaj u
Mejen a jun tuul ilic tu bajili. Ti baalo'o,
tulacal a mac a que'en u yool tu
pach u Mejen a Dioso, ma'
pula'anoo'i. Tz'abi ti'ijoo' a
cuxtal a ma' yan
q'uin u
jobolo.



Romanos 3:23

tulacaloo' a cristianojo, u laj cüxtajoo' u sip'il. Ma'ax mac u betaj a jabix u c'ati a Dioso, ti'i ca' aalbüc u qui'il,

Romanos 6:23

Yan u naal mac a tan u cüxtic u sip'ili. Le'ec u naal abe'e, le'ec a beel ich c'asili. C'u' betiqui, u sij-ool a Dioso, le'ec a cuxtal a ma' yan q'uin u jobolo. Yan a cuxtal abe' ti'i mac a que'en u yool tu pach ti Noochil a Jesucristojo.

Hebreos 9:27

Pues te'i. Tz'abi ti'ijoo' a cristiano ti yan u quimiloo' jun sut ca' tun tz'abücoo' ich u sip'il.



Efesios 2:8,9

Chen u men u qui'il a Dioso, sa'ala'ano'on u men ti tz'aj ti wool tu pach a Cristojo. Sa'ala'ano'on pero ma' etel ulaac' tac a ba'al ti betaji. Chen yoc'lal u sij-ool Dios ti sa'ala'ano'on. Ma' sa'ala'an a mac yoc'ol ulaac' ba'al u betaj ala'aji. Wa cuchi jede'ec u paatal u sa'altic u bajil etel a c'u' u betaja, jede'ec cuchi u paatal u yadic u qui'il tu bajil pero ma' yan biqui.

Romanos 10:9,10

Baala' a quich'pan t'an ti'i a jujun tuulu. Yan u tz'ocsic ti ca' cuxlaji a Jesus u men a Dioso. Yan ilic u yadic ca' u'yajbüc ti le'ec a Jesusu, le'ec u Noochil. Ca' u bete' ti baalo'o, bel u ca'a sa'albül u men le'ec mac a walac u tz'ocsic a Jesus ichil u tuculu, tojaji u tucul etel a Dioso. Le'ec ti tan u yadic ca' u'yajbüc c'u' a tan u tz'ocsiqui, sa'albül u ca'a.



San Juan 3:16,17

Pues te'i. A Dioso, top yaj u yuboo' a cristiano yoc'olcaba, mentücü, u c'ubaj u Mejen a jun tuul ilic tu bajili. Ti baalo'o, tulacal a mac a que'en u yool tu pach u Mejen a Dioso, ma' pula'anoo'i. Tz'abi ti'ijoo' a cuxtal a ma' yan q'uin u jobolo. Le'ec a Dioso, u tücaa'taj u Mejen ichil a yoc'olcab ma' ti'i ca' tz'abüc a cristiano yoc'olcab ichil u sip'ili. U tücaa'taj ca' sa'albüc a cristiano yoc'olcab u men u Mejene.



1 Juan 5:11-13

Bel in quin wadü' te'ex c'u' u yadaj a Dios yoc'ol u Mejen. U yadaj u tz'eec to'on a cuxtal a ma' yan q'uin u jobol. U yadaj ti jadi' ilic etel u Mejen jede'ec ti c'ümic a cuxtal abe'e. Le'ec mac u c'üm-ooltaj u Mejen a Dioso, yan ti'i a cuxtal a ma' yan q'uin u jobolo. Le'ec mac a ma' u c'üm-ooltaj u Mejene, ma' yan ti'i a cuxtal abe'e. Pues te'i. Le'ec boone'ex a que'ene'ex a wool tu pach u Mejen a Dioso, tan in tz'iibtic te'ex a carta ada'a. Tan in tz'iibtic ada'a, ti'i ca' a weelte'ex tu jajil ti yan te'ex a cuxtal a ma' yan q'uin u jobolo.



San Juan 14; 2 Corintios 5; Revelacion 4, 21, 22

Storyline by: Edward D. Hughes

Illustrated by: Lazarus
and Alastair Paterson

Adapted by: Sarah S.

Maya, Mopán NT (mop) © 2012, Wycliffe Bible
Translators, Inc. All rights reserved.

<https://live.bible.is/bible/MOPWBT/MAT/1>

©2026 Bible for Children, Inc.

www.M1914.org

www.bibleforchildren.org

