

www.BibleForChildren.org



Yon 14



Yesuse e okok aleyemin naka ni baabenea Ib bobol
tem daako ilumo mo omfubenomone! Ibo Gode
bainobo gena bianiba nesa bainobo getne nabianibte!
Sino ne baabenia Ne monia ib amo klaubenamabibo
ge baabeibu olo bainobe.



Ne Aye bie bib olo amo homon eka bib osa beselib nabe. Bib olo temo ib am osa ye biobe. Ne monia ib amo klaubenimio imin tenia dleb ut daia ibtem netem nanoba bib olo nomabbiobe.



Ne Yon ib nek netabe. Nib dabwalo Yesus emibe.
Nibo Gode kimanino tem wat biob kesoa nibo
Yesus emibe. O dafa ota nakai Gode

wasi dofa blibi nibo bobol
tem abil osa enin osa



omkayebiobe.



I inayebib otane nibo alukum sbal mabuobe. Ne
Gode wengo omkeima biania eka Yesuse
dowan wengo omkeima biam bli o dafa

ota klabuto ge nemeb
teniba aa ubile niniino



Fatmos ele daib
biotabe.



Weng olo onebo blimanoa omito ne temia abilimo
amisalo betelanoa eka weng mako sino bigul weng
dikine obabiba wentibuo baanoa Kobo ute asal ele
tleba ne inamin namino mitdanoa tam tlamabo
alebkenano gesoa wentena
bia hebamsab Hobe nemeb
utnea abilim ut . . .

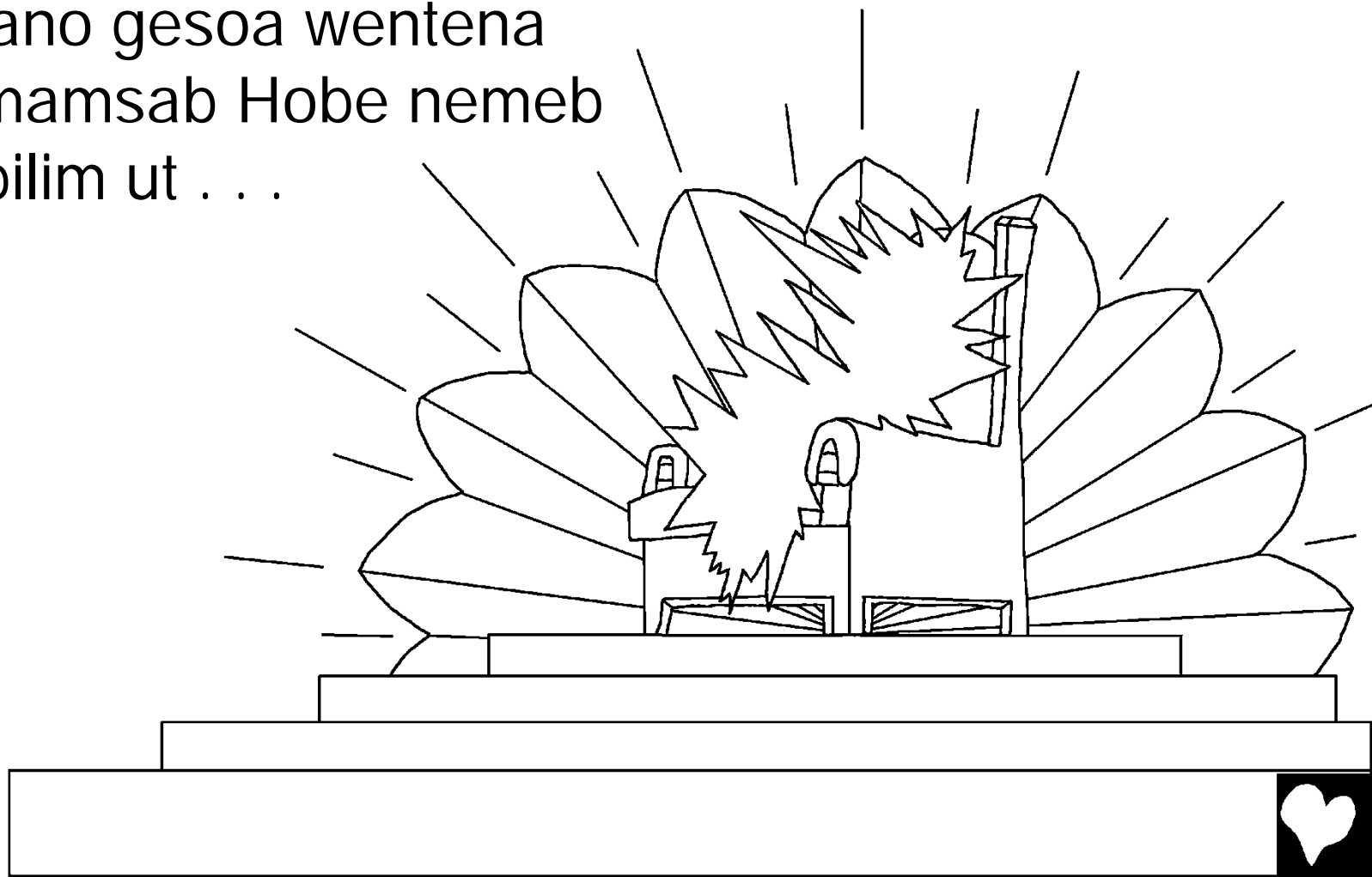

. . . dasea temia komokwali biino dimo naka make
toumbia atemie e kibio makob tomo moni sumo
yasba esa eka tom ilemo konilian osa o undim
inamin dat genebua kwese komokwali biino ge
omfakanebua watemibe.

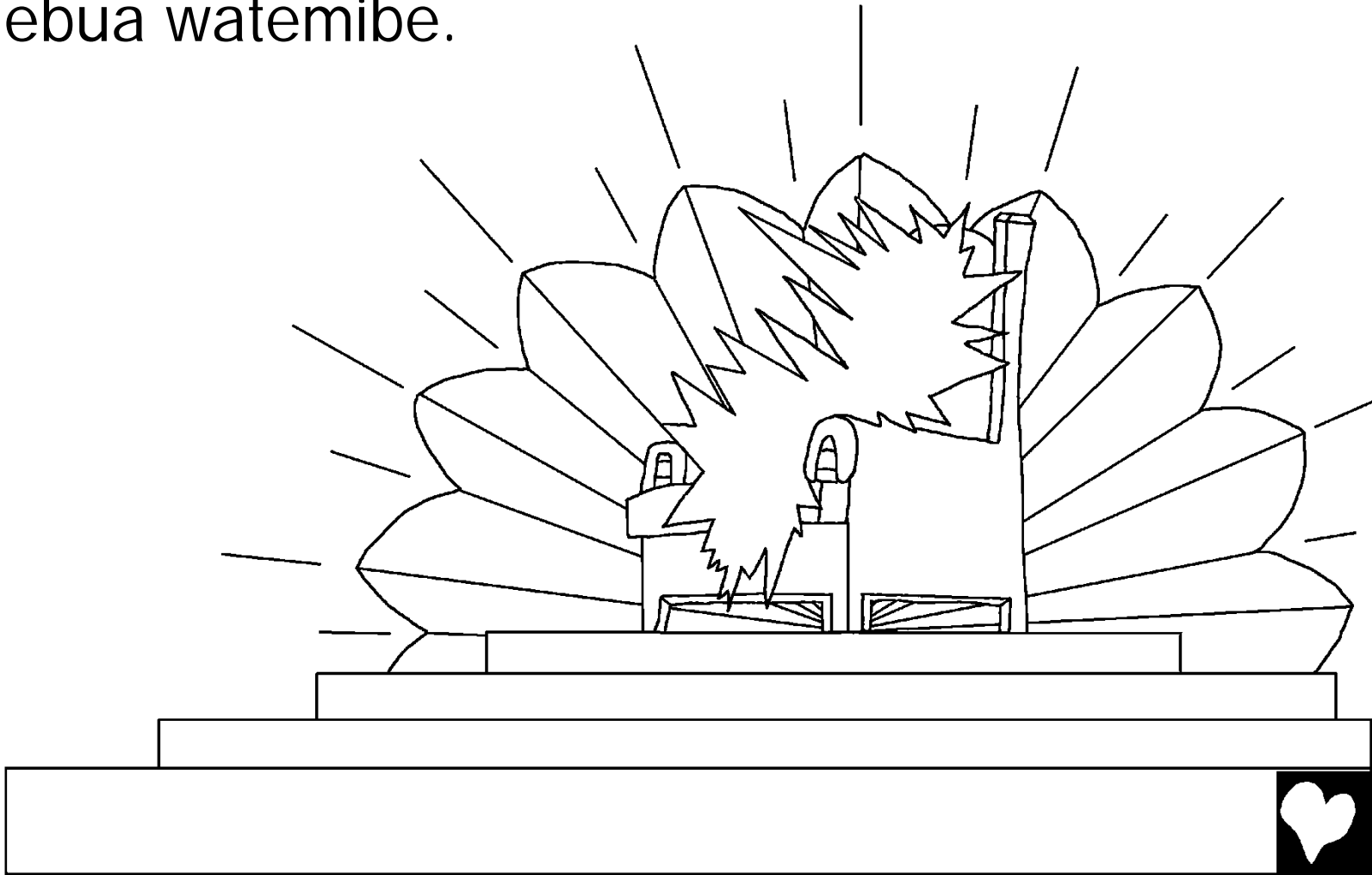

Inamin kesoa nakaia unangai e niniino dobtouleb
bianiba eka e seinha bianiba E ayamobo ge oha
bianomabiobo ge ngambiba
wentena bia eka inamin namini
Gode klanebuei abilim ut blib isa
eka dabalim olo blib isa eka dabal
tem daako blib isa eka aaye sole
dang daak blib
isa baaniba Ni
komoke biin
dimo toumbie
elesa eil
sibsib men
esa i . . .

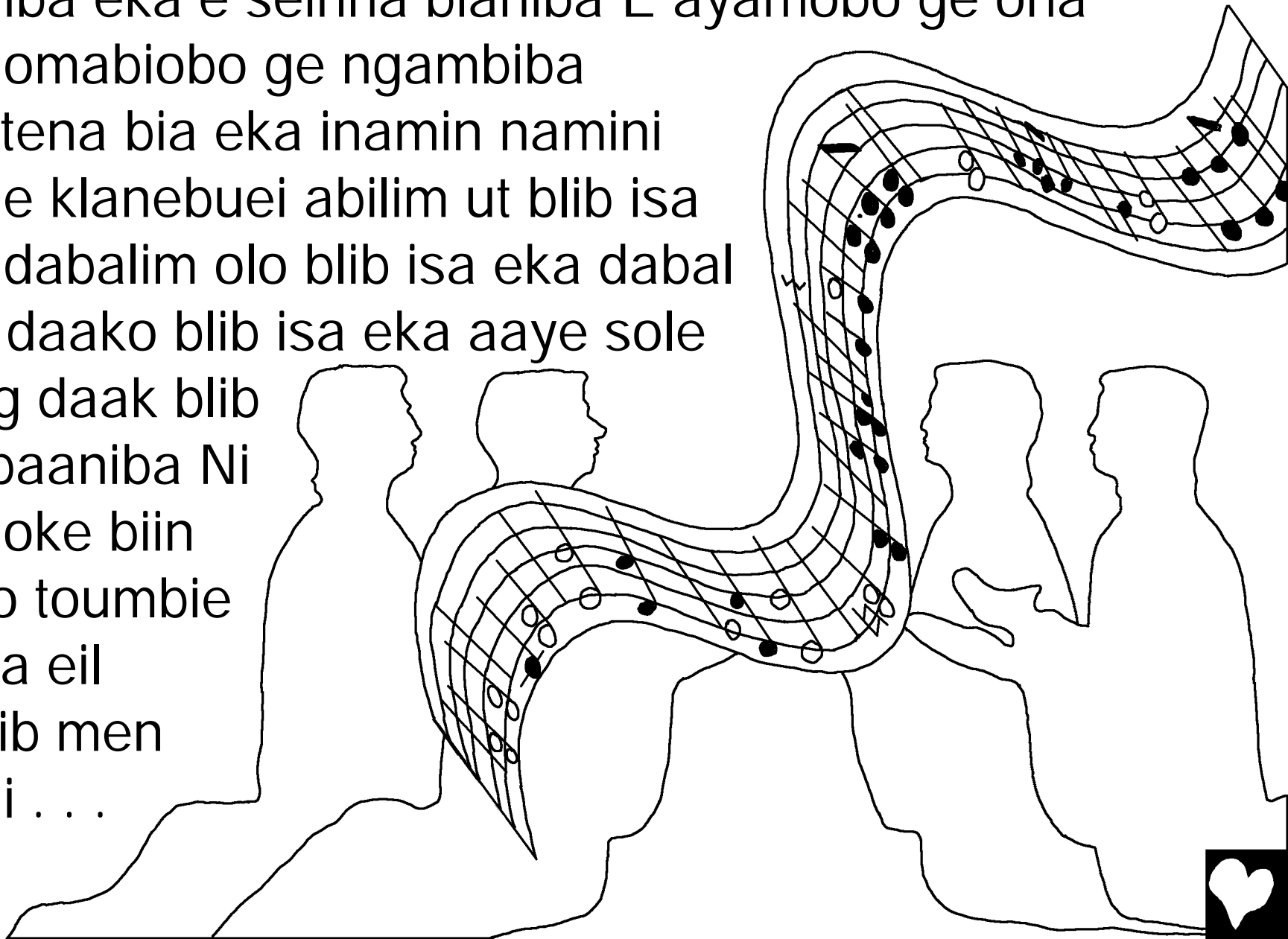

. . . niniino ni amitie dobtouleb biobobe. I sum eka
ayam nabe. I titilo sumobe. I kukub ayamo mo
blimubenamabobabe. I kukubo
amit ninobo ge obiba eka inamin
namini asuke asuke nai afen
smiksa isa baaniba Bainobo
genabiba eka komokwali dlong
dlong golbua
toulaniba i dum
i niniino
dotouleb na
bliba
yatemibe.

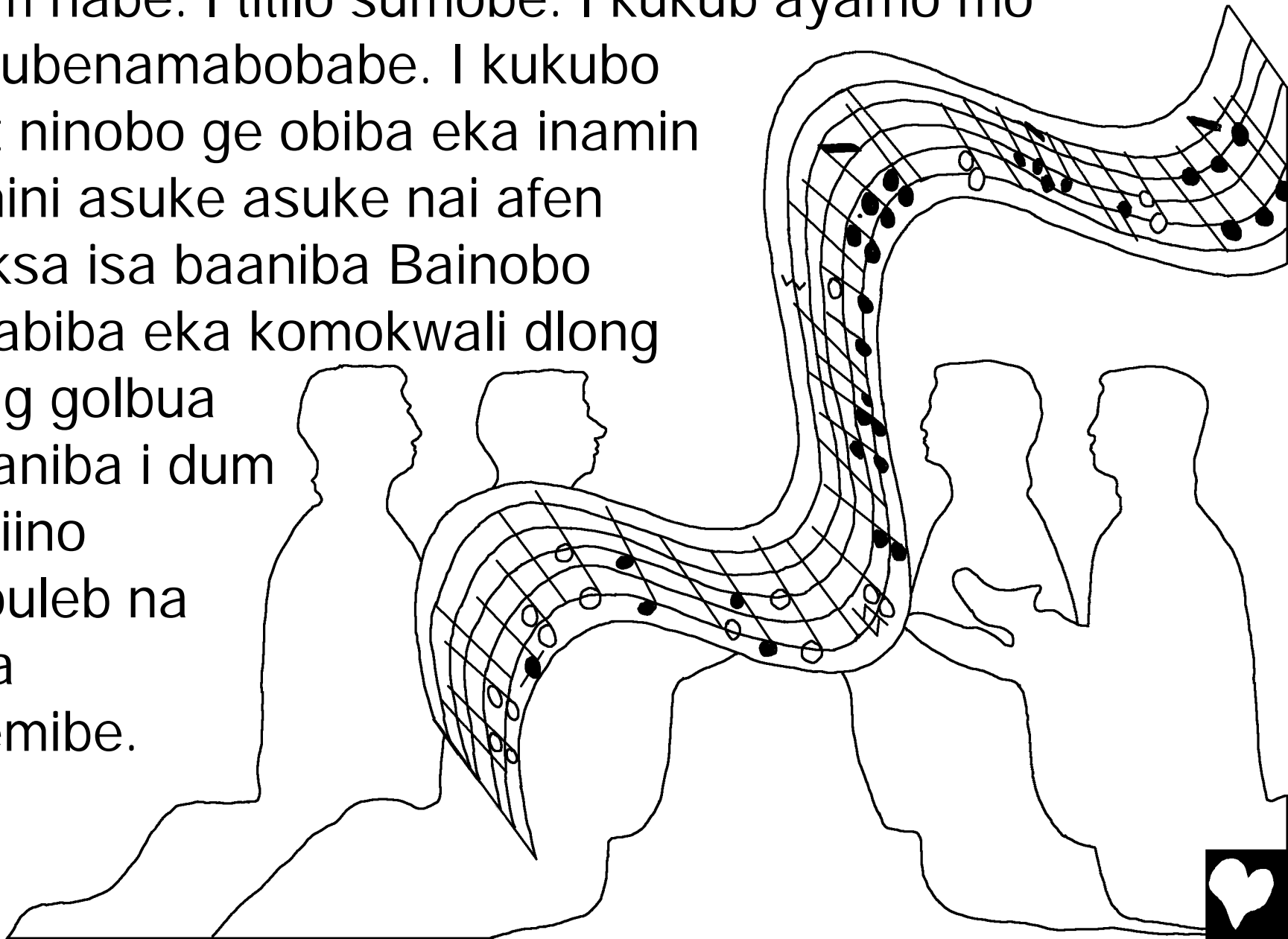

Ne bib mako watemi olo bib ayam kiningobe. Bib olo mema Yelusalem bib otabe. Bib olo God esu wit bianoa abilimo deibonoa tebua watemio o eito makob unangi imakwali dlom geniba youmo memao olo kiniba dlonabib inaminobe. Eka weng mako komoke biin dim

ut danoa
ngambianoa
Etemine!

Memalo Gode
bibamo nakaia
unangai bekebenobe.
I Gode meletan aiba
eka e i Sum anea item
etem nanomabiobe.

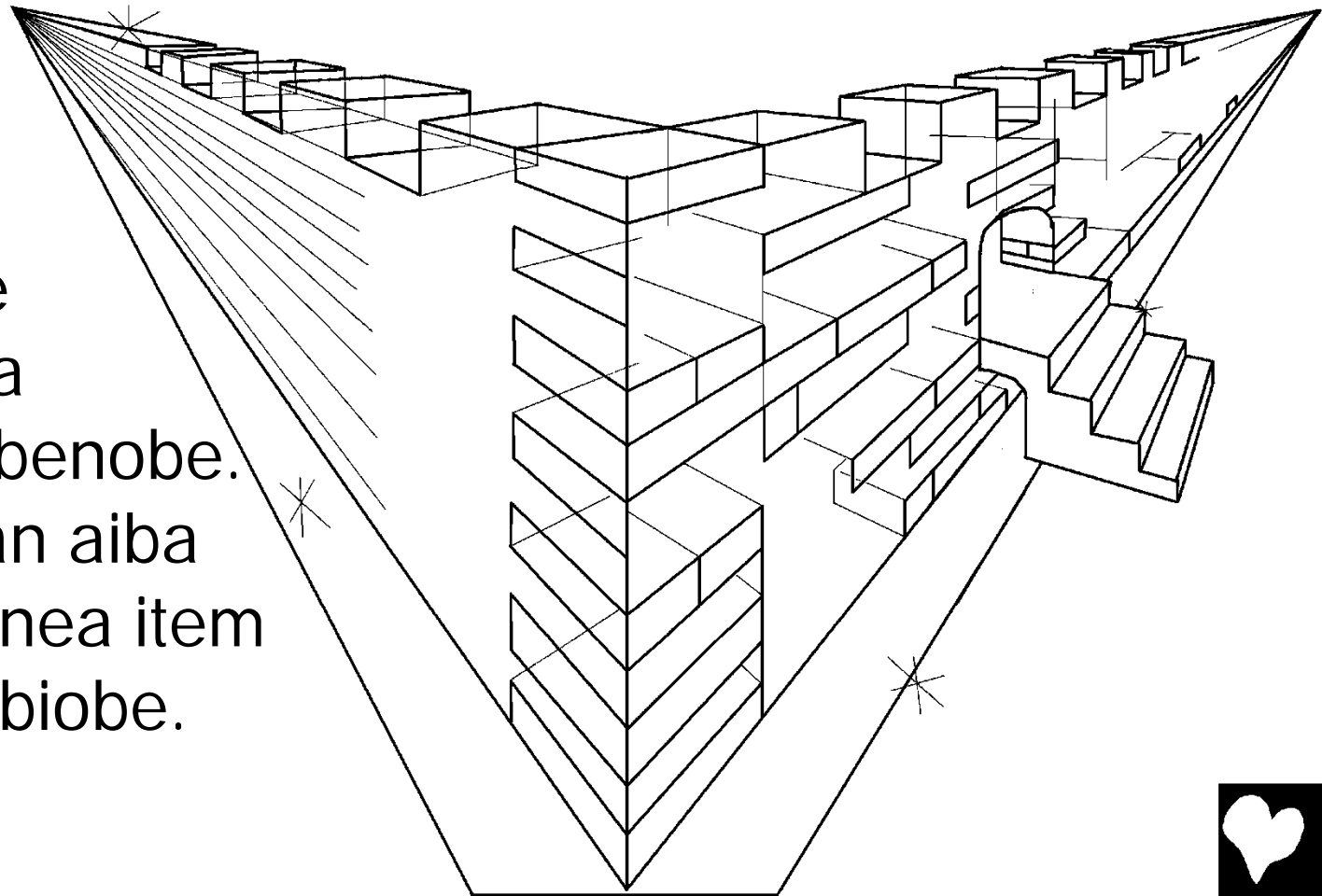

Eka abisake aaye nakai downaibo amit nomabibe
aletnesea temia binigowanea makob aakikit inanebua
atemio aay ele God esa eil sibsib men esa i biin dim
wat danea tlanea bib dang tla unebetabe.



Bib olo afoka alimao mo tubu biobabe. Gode titil ota ayal inamin eibiobe. Eka eil sibsib men ele bib olo ayalobe.



I inanomabib otane
kukub misiam osa eka
nakaia unangai kukub
misiampo nabib isa eka
nakaia unangai weng
dimo obib isa ile bib
olo mo tam
unomabibbabe. Eil
sibsib mene e afen
smik buko temo nakaia
unangai niniino
dolabenebio ita bib olo
tam unomabiobe.



E i memino omtlabenea imino
mo kaaniba eka i bobol tem osa
mo misiamu benanomobabe. I
mo mebianiba enin osa mo
omubenanomobabe. Sin kukub
olo alukum blimanamabobo
gesoa wentibe.



Eka inamin namin kukubo Gode mo gobo bieba ole
fotebenea unoa Gode eil sibsib mene i dum ta komoke
biin dimo toula bianiba nakaia unangai kima bliba
Gode e okok nakai e niniino dobtouleb nomabiobe. I
ina bianiba Gode kla
atemnabibta e i
debelon dimo e
niniino
dolabenamabebe.



Eka ne nakaia unangai kulila binabibi yatemala niniin
sum isa eka niniin gwab isa komoke biino kibi kaba sin
ye masiba nakae komoke biin olo dimo toumbie buko
bamtabanea eka buk mak osa bamtaba nanea atemio
nakaia unangai niniino buk olo temo bibe
bio nakai amit nomabiobe. Buk olo niniino
afen smik bukobe. Eka e kulilaibbuei
kukubo alukum motomanea
watemea wengo buk
mako temo bio kesoa
watemnea i kukub
nabibo olota klanea
nakaia unangai aaye sole
tem daak kaaibbuei imin
hananabiba eka nakaia . . .

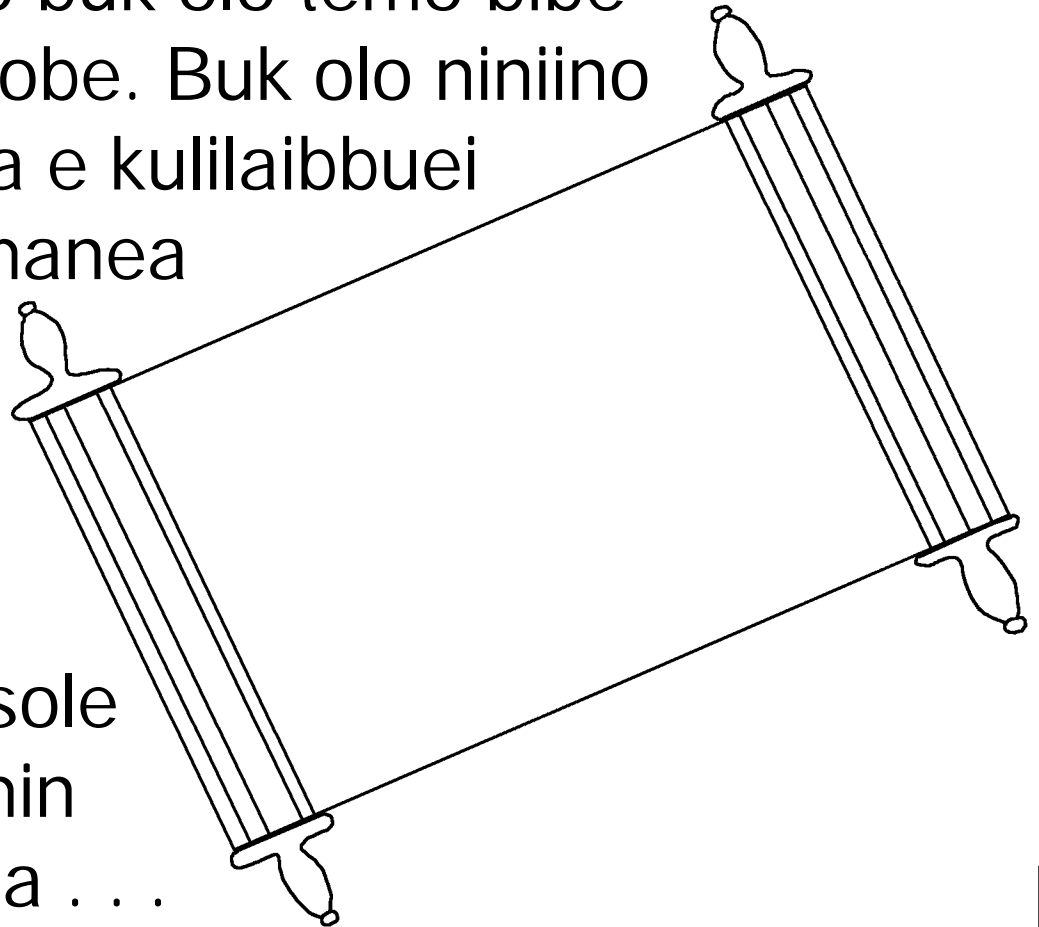

. . . unangai kaaibbua kaanamin bibo blib isa imin hana
tenaiba kukub klamin nakae i kukubo watemnea
klaneakaanamin bib osa eka kaanamin kukub osa
ombianea daaknoa ase sume dabal tem daake eimbe
tem daak unobe. Kukub klamin nakae afen
smik buk olo temo watemala nakaia
unangai niniino blim bio mole ile
dolbianea daakniba dabal tem
daake ase sume
eimbe tem daak
unomabiobe.

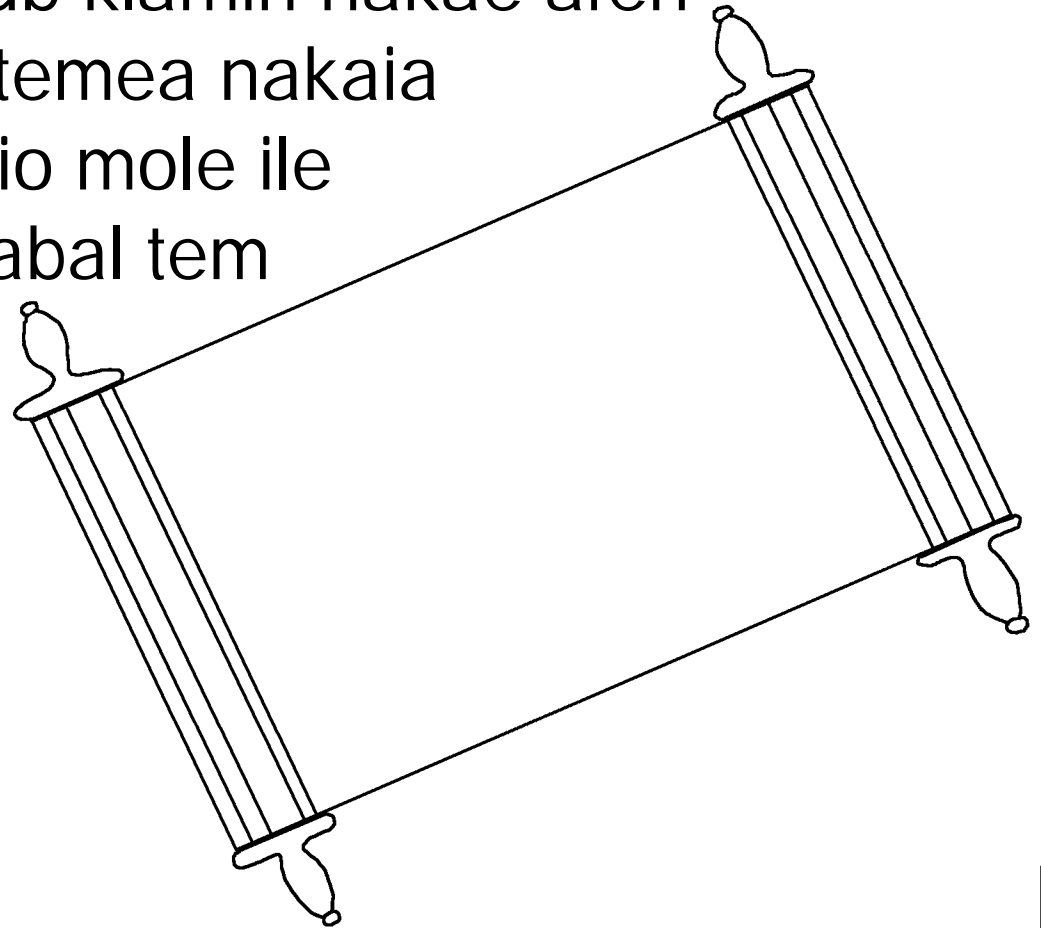

Gode Hob esa eka eil sibsib mene alel osa baaniba
Yesus kobo tele gesiba wentibe. Eka nakaia unangai
wanita i weng olo wentib mole isa baaniba Kobo tele
geine!



Eka nakaia unangai wanita aa tebo kaanom genabib
mole tline! Eka nakaia unangai wanita aaye
downonomo geib mole teniba Gode afen smik aaye
misim dobye ele doweine!



Gode dabalim
nakaia unangai kla
dohalim bianea kla gobe bie kesoa e
miin yanmakob ne nemanea tenia atdimmo
kaania nakaia unangai daabenamabi
kesoa nakaia unangai wanita ne
bainobo getnenimibi mo kaanibta
alang namanimibbabe.





I afen smike amit nine doboniba amit
nomabiobe.

60

60



LOM 3:23 Dabalim nakaia unanga nibo alukum hengmino
henganobbio kesoa nibo Gode hengmino blim ayam
esuo mo biobbabe.

LOM 6:23 Ne wengo baabeio mitmakamo enaminobe.
Nakaia unangai hengmino hengabib mole Gode i
hengmin kukubo molo yang kenea i kaanimibo God esuo
mo nomabibbabe. Ina otane nakaia unanga ibo nib Sume
Yesus Klaiste tenaniba ib bobol tem funino makob aib
mole Gode afen smike amit nine misim dobyamabebe. E
afen smik ele dobyameo ibo mo yang kenimibbabe, besa
doboniba amit nomabiobe.

Hiblu 9:27 Nakaia unanga nibsa alukum deib makob kaan
kaan biob bita sinanomo Gode nib kukubo klanamabebe.



Efesus 2:8,9 Nibo Yesus Klaiste bainobo genobbuo Gode e bobol ayamo nibo omyenea daabenea nibo hengmino temo biobo dotlanebiobe. Nibo hengmino temo biobo nib malo mo deibueim blimobe. Gode ele bobol tem funanea nibo bobol ayamo omyenea hengmino temo biobo dotlanebiobe. Gode nib kukub ayamo nabobo mo yateneta nibo hengmino temo biobo dotlaim blim kesoa nibo naka maki mo baabenobta Ni kukub ayam olo nabob ota Gode ni hengmino temo biobo dotlanebiobo ge baabenomobe! Gode emaye ele bobol tem funanea bobol tem ayamo nibo omyenea dotlanebiobe.

LOM 10:9,10 Ibo Yesuse niniino omkeimaniba baaniba Yesuse Sum kesoa e nakaia unanga nisa eka inamin namin osa alukum kima biebo ge baana bianiba eka ib bobol tem osa funaniba Bainobo, Yesuse kaane otane Gode imin dofaanea hananebiobo geib mole Gode ibo hengmino temo blibo dotlanamabebe.



Niminbabe, nib bobol temo bainobo gabobo Gode nibo baabenea Ibo ne kin dimo hengmino blimobo gabebe. Eka nibo nib bainobo galino omkeimabob mole Gode nibo hengmino temo biobo dotlanamabebe.

Yon 3:16,17 Gode dabalim nakaia unangai kla dohalim bianea kla gobe bie kesoa e miin yanmakob ne nemanea tenia atdimo kaania nakaia unangai daabenamabi kesoa nakaia unangai wanita ne bainobo getnenimibi mo kaanibta alang namanimibbabe. I afen smike amit nine doboniba amit nomabiobe. Gode e miin ne mo nemane tenita dabalim sel nakaia unangai hengmin gami kot kebenea dlanea aseinin bib unine geneta nemaneta tlim blimobe. E funanea Ne dabaia daaknea dabalim sel nakaia unangai hengmino temo blibo dotlaneko geneta namaneta daak tlibiobe.



1 Yon 5:11-13 Weng olo enaminobe. Gode afen smike amit nine nibo dobyebuo o mitmakam ole e miin etabe. Nakae waneta Gode miine e bobol temo biba bie mole e afen smike amit nine debebiobe. Eka nakae waneta Gode miine e bobol temo mo biba bieba mole e bobol temo afen smike amit nine blimobe. Ne futan olo dolania nakaia unangai Gode miine niniin dimo bainobo gabib ibo omfubenamabio inaminobe. Ne funania Ibo tekein keniba ni afen smike amit nine dobobbiobo geine genita futan olo dola omfubenamabibe.



Yon 14; 2 Kolin 5; Lebelesen 4, 21, 22

Storyline by: Edward D. Hughes

Illustrated by: Lazarus
and Alastair Paterson

Adapted by: Sarah S.

Mian NT (mpt) © 1986, Wycliffe Bible Translators, Inc. All
rights reserved.

<https://live.bible.is/bible/MPTWBT/MAT/1>

©2026 Bible for Children, Inc.

www.M1914.org

www.bibleforchildren.org

