

# Baebele ya bana

## E tlesa

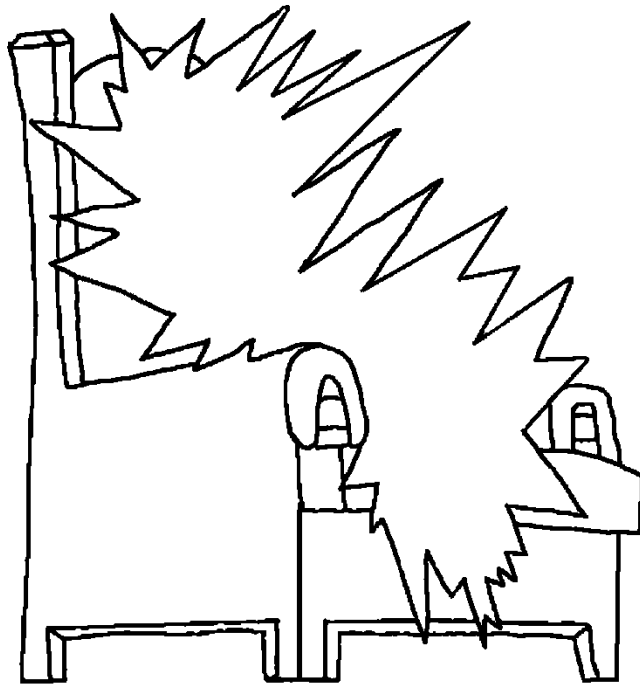

Legodimong,  
gaeng lere  
botse la  
Modimo



E kwetse ke: Edward Hughes  
E bontsitshwe ke: Lazarus; Alastair P.  
E lomagantswe ke: Sarah S.  
E phetotswe:  
E ntshitswe ke: Bible for Children  
[www.M1914.org](http://www.M1914.org)

BFC  
PO Box 3  
Winnipeg, MB R3C 2G1  
Canada

©2021 Bible for Children, Inc.  
Letlelelo: O na le tshwanelo ya go lebelela kgotsa go kwala  
polelo e, fela ga o sa e rekisi.



E rile Jesu a phela mo lefatsheng, o ne a bua le ba  
rutwa ba gagwe ka ga legodimo. O ne e bitsa legae  
la ga rara, ebe are, go na le ma  
madulo a magolo kwa teng.

Legodimo le gae le le  
golo le lentle thata  
go feta mo  
lefatsheng.

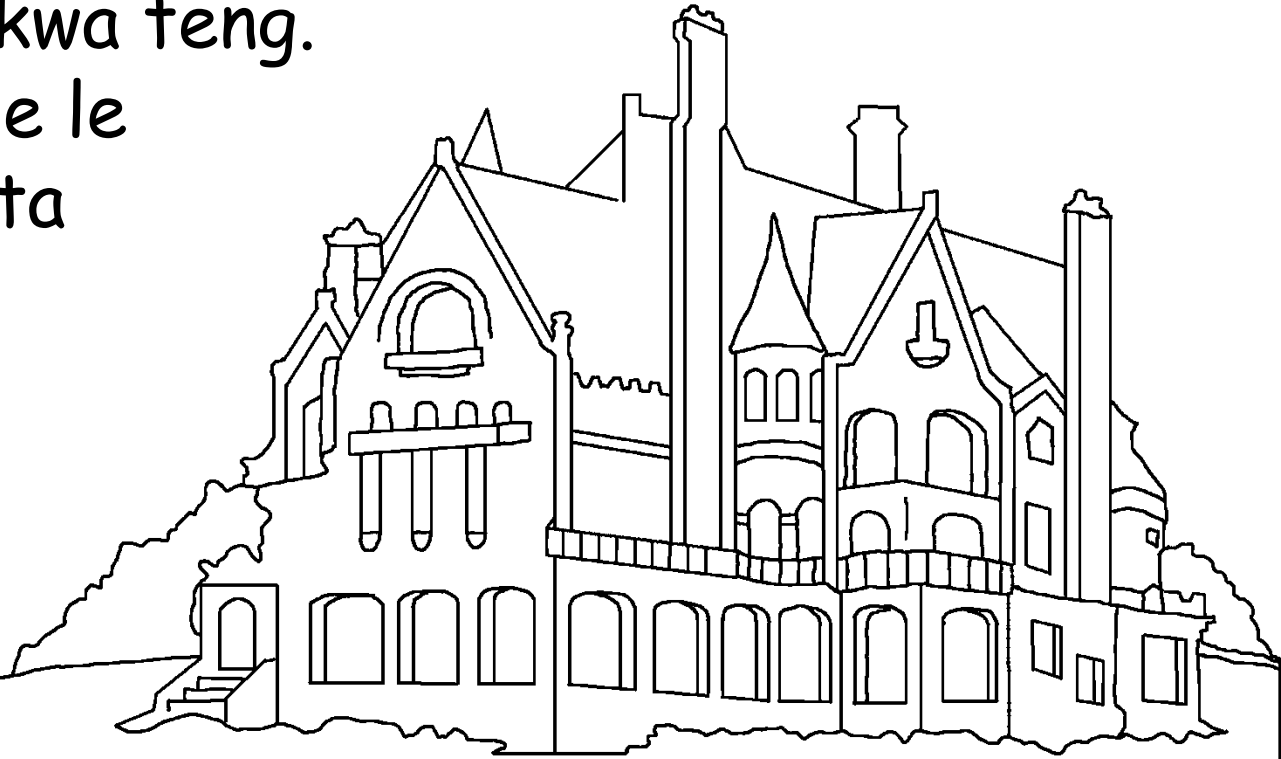

Jesu are, kea go lo bankenyetsa felo, ga ke tsamaya go le bankanyetsa ke tla boela morago gape go lo tsaya. Jesu o ile legodimo morago ga go tsoga baswing, ga barutwa ba gagwe ba mo lebeletse a amogelwa ke maru.

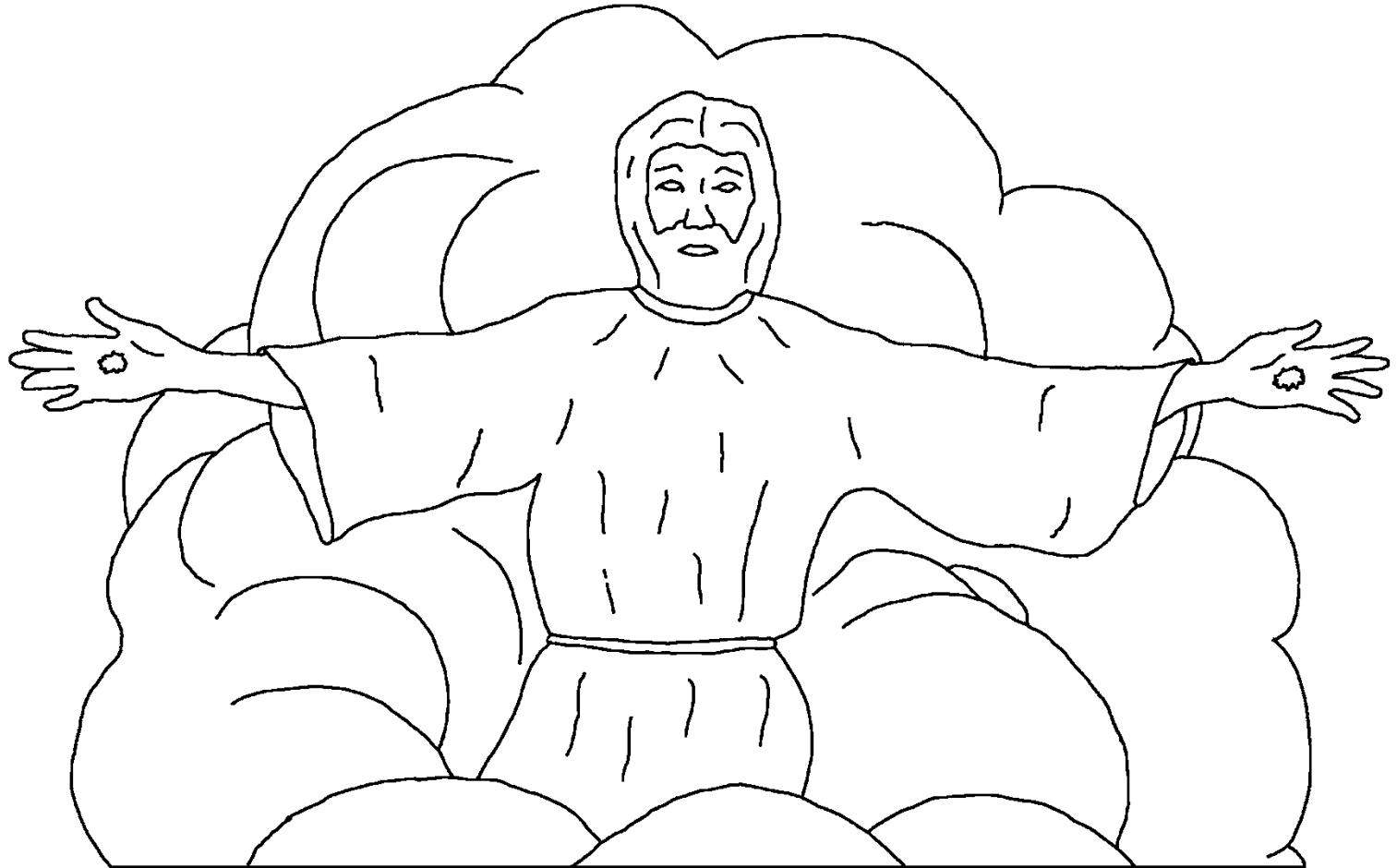

Ba keresite ba gagologelwa di tshepiso tsa  
ga Jesu gore o tlo boa gape. Jesu o rile o tla tla ka  
tshoganyetso mo re sa mosolofelang.

Jaanong ka ba keresite ba ba  
swang pele a boa? Baibele  
ya re batla ya go Jesu.  
Go swa mo nameng ke  
go phela le morena.



**GONOBJALO LE  
MODIMO**



Tshenolo, buka ya bofelo mo baibele, e re bolelela  
ka bontle jwa legodimo. Se sentle ke gore legodimo  
ke legae la Modimo. Modimo o gongwe  
le gongwe, mara bogona  
ba gagwe bo ko  
legodimong.

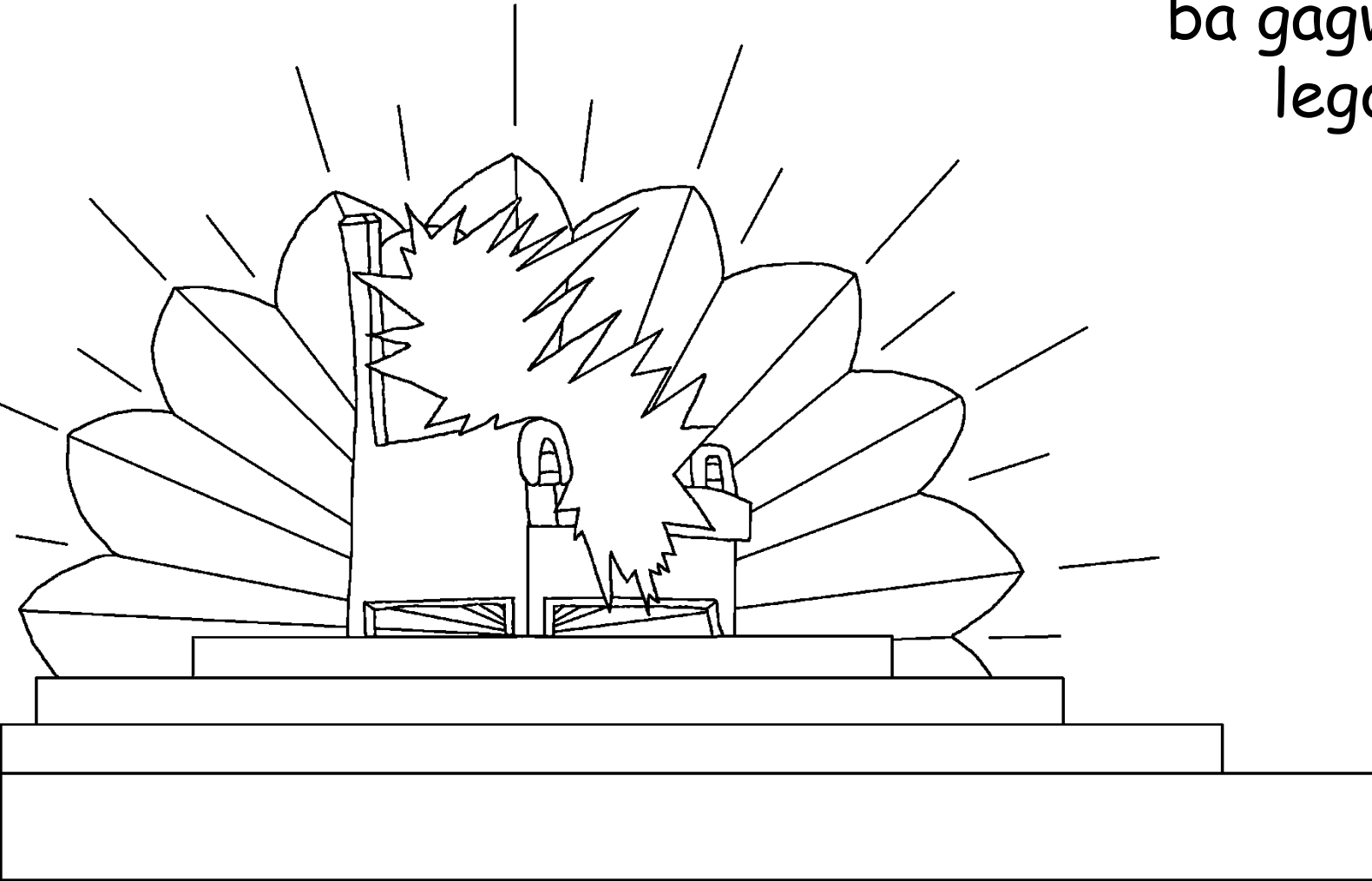

Baengele le batho bamagodimo  
ba galaletsa Modimo kwa  
legodimong, le batho botlhe  
ba ba swileng ba galaletsa  
morena le bone. Ba  
opela di pina tse  
dintle go mo  
galaletsa.

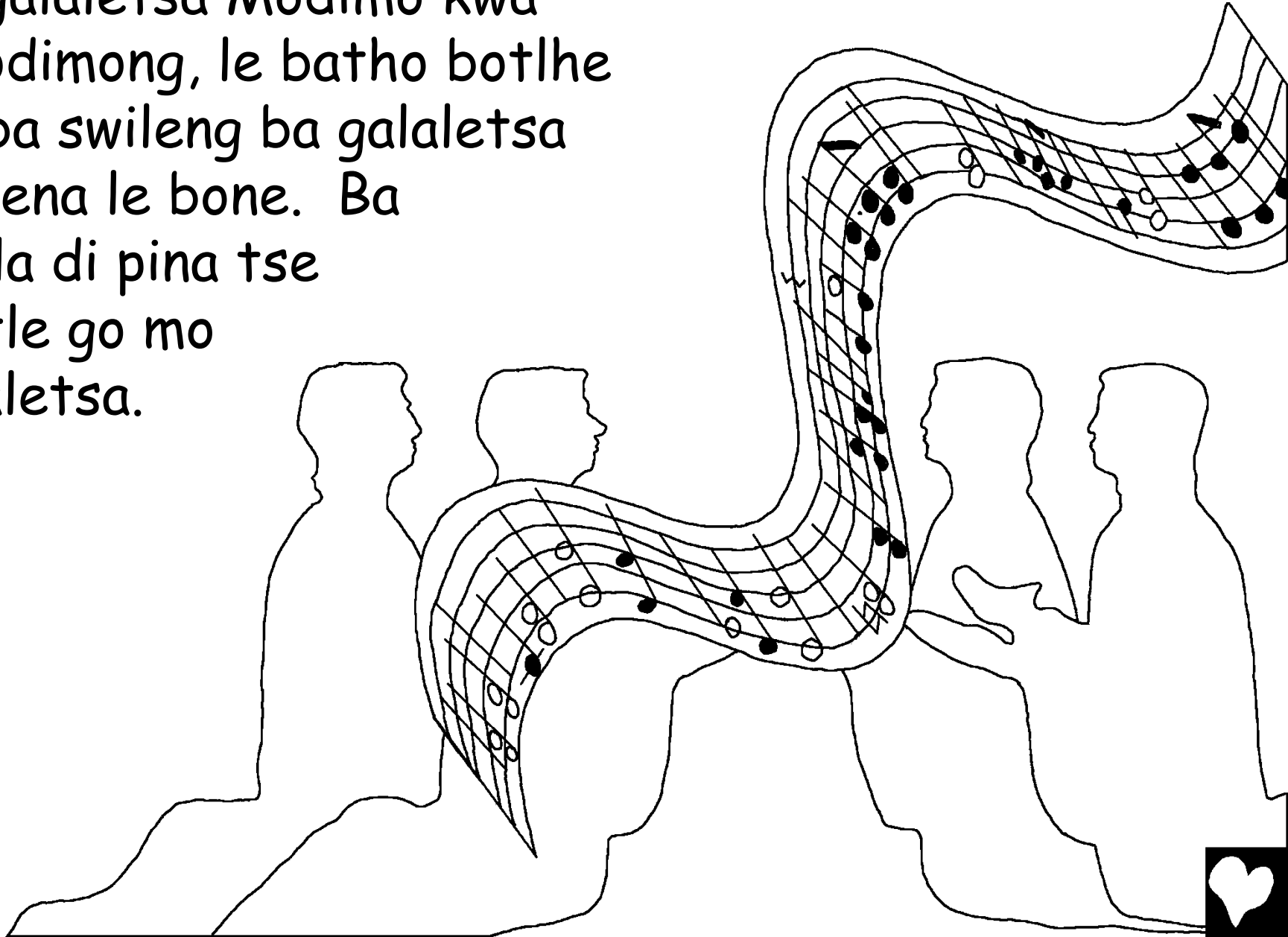

Ba opela sefela se sesha ba re; Go go tshwanetse go tsaya lokwalo le go kanolola dikano tsa lone, ka o tthabilwe; mme batho ba ditso tsothe le ba dipuo tsothe le ba merafe yotlho wa ba rekolelela Modimo ka madi a gago, wa ba dira dikgosi le baperesiti ba Modimo wa rona ba ba tla busang mo lefatsheng.

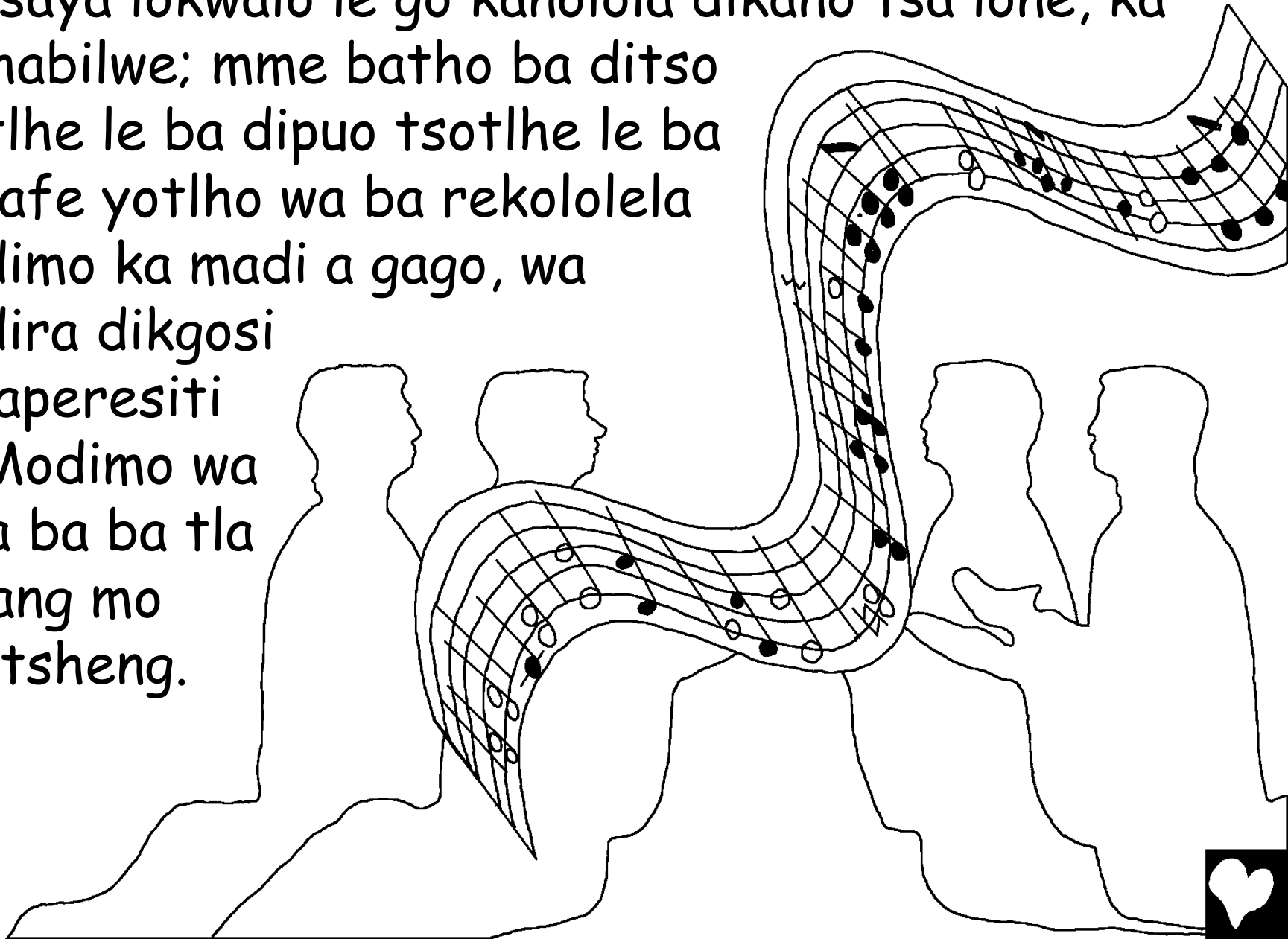



Mafoko a bofelo mo baibeleng a bua ka ga  
Jerusalema e ntsha, e dirilwe ka matlapa a kwa go  
dimo thata a gauta, a patshima godimo le fatshe.

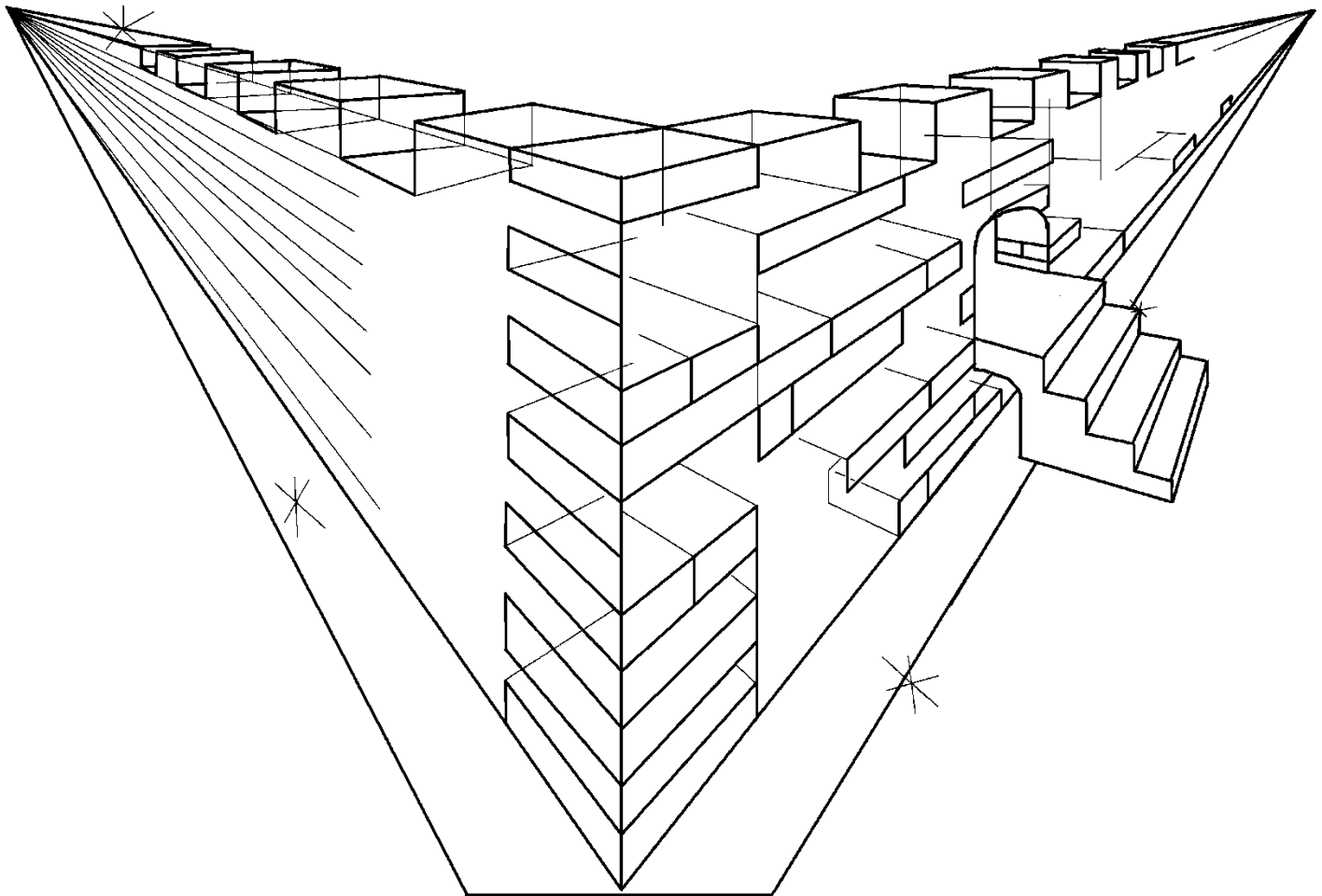

dikgoro tse digolo tsa legodimo ga nke ditswalwa, a re tseneng re bone gore go gontle jaang ... heela! legodimo le lentle tota mogare. Lefelo la teng le dirilwe ka gauta, le di tsela tsa teng di dirilwe ka gauta.

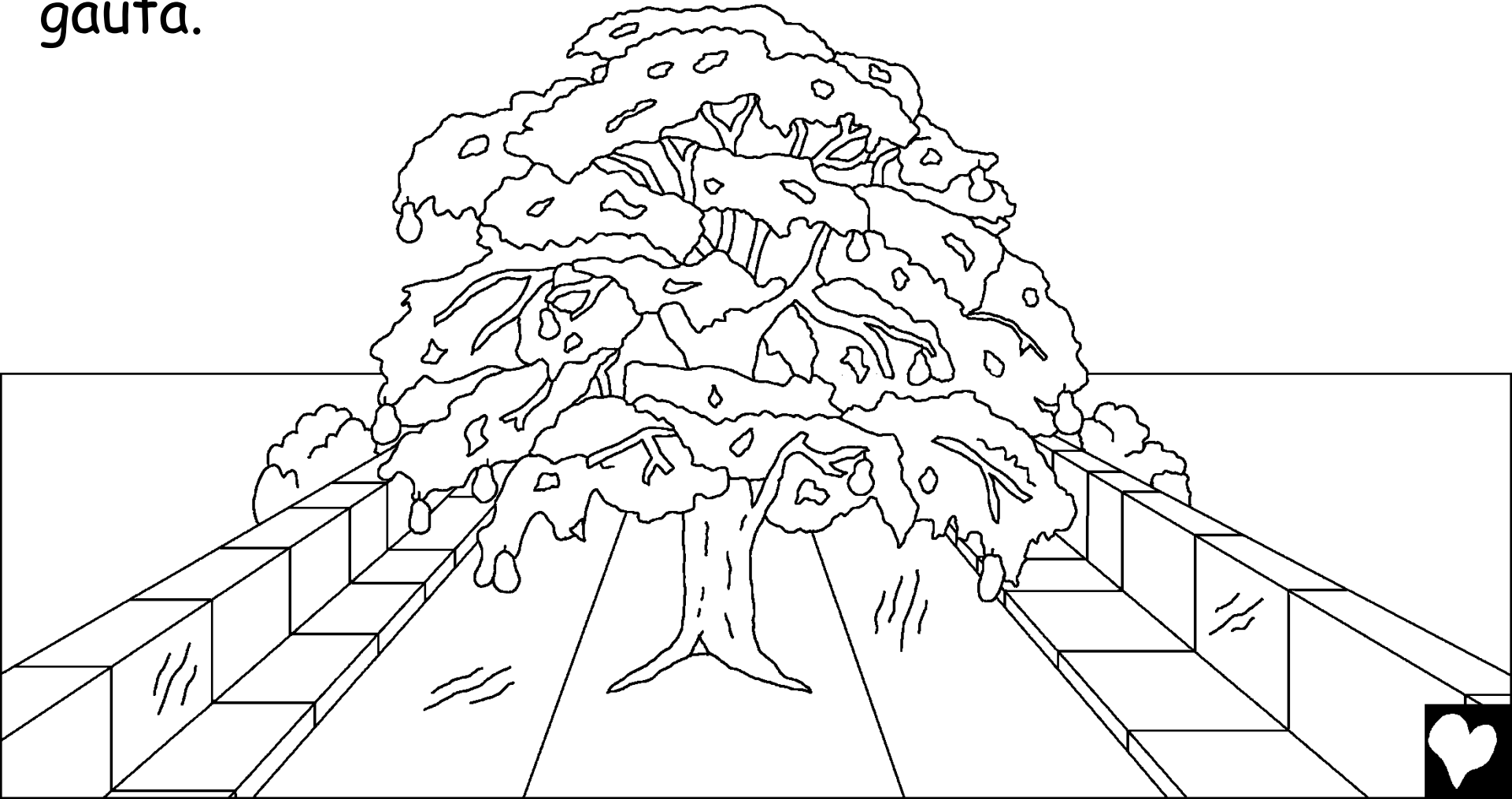

Noka e entle ya metsi e elela go tswa boteng jwa Modimo. Gaufi le noka, go nna le setlhare sa bo phelo, e le setlhare sa ntlha mo tshimong ya etene. Setlhare sena se bo tlhokwa thata, se ntsha maungo a le 12 a farologaneng kgwedi engwe le engwe. Le matlhare a sona a tliša pholo mo di tshabeng.

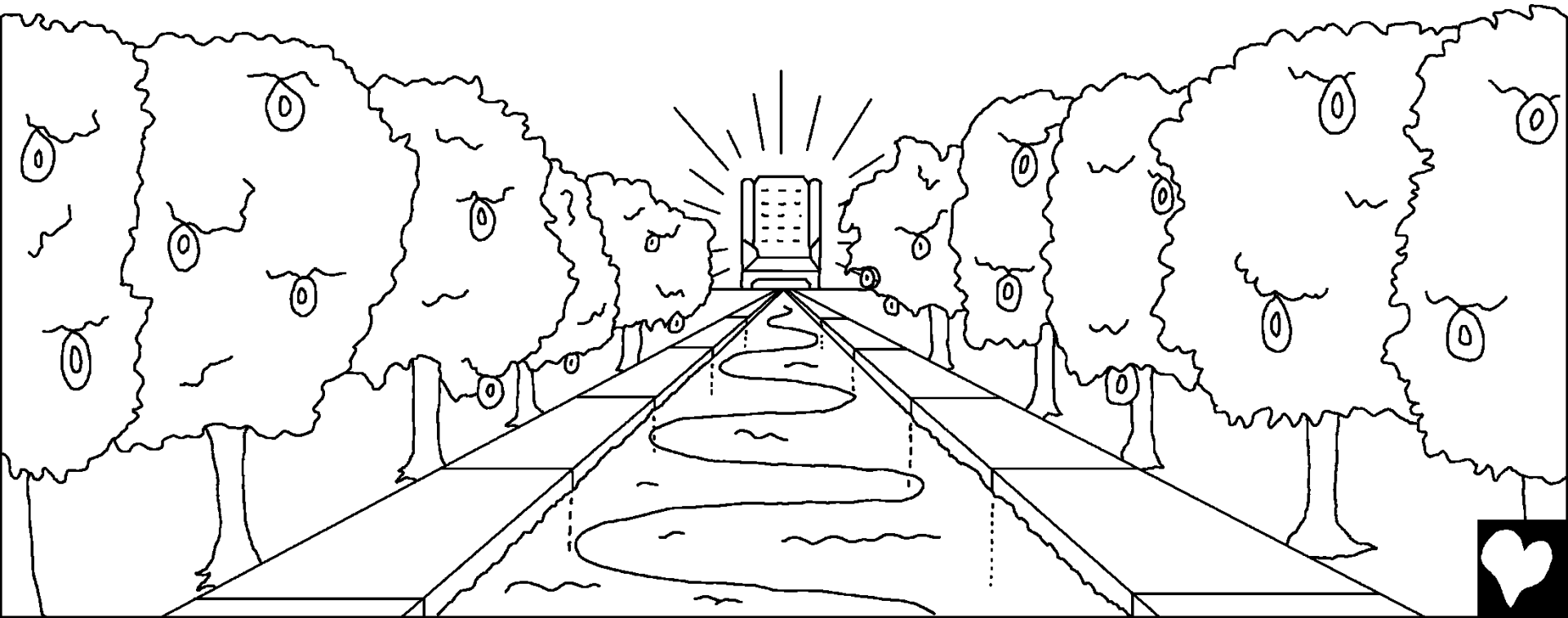

Legodimo ga le tloke letsatsi kgotsa ngwedi gore go kganye. Kgalalelo ya gagwe e tletse ka lesedi. Ga go nke go nna bosigo.

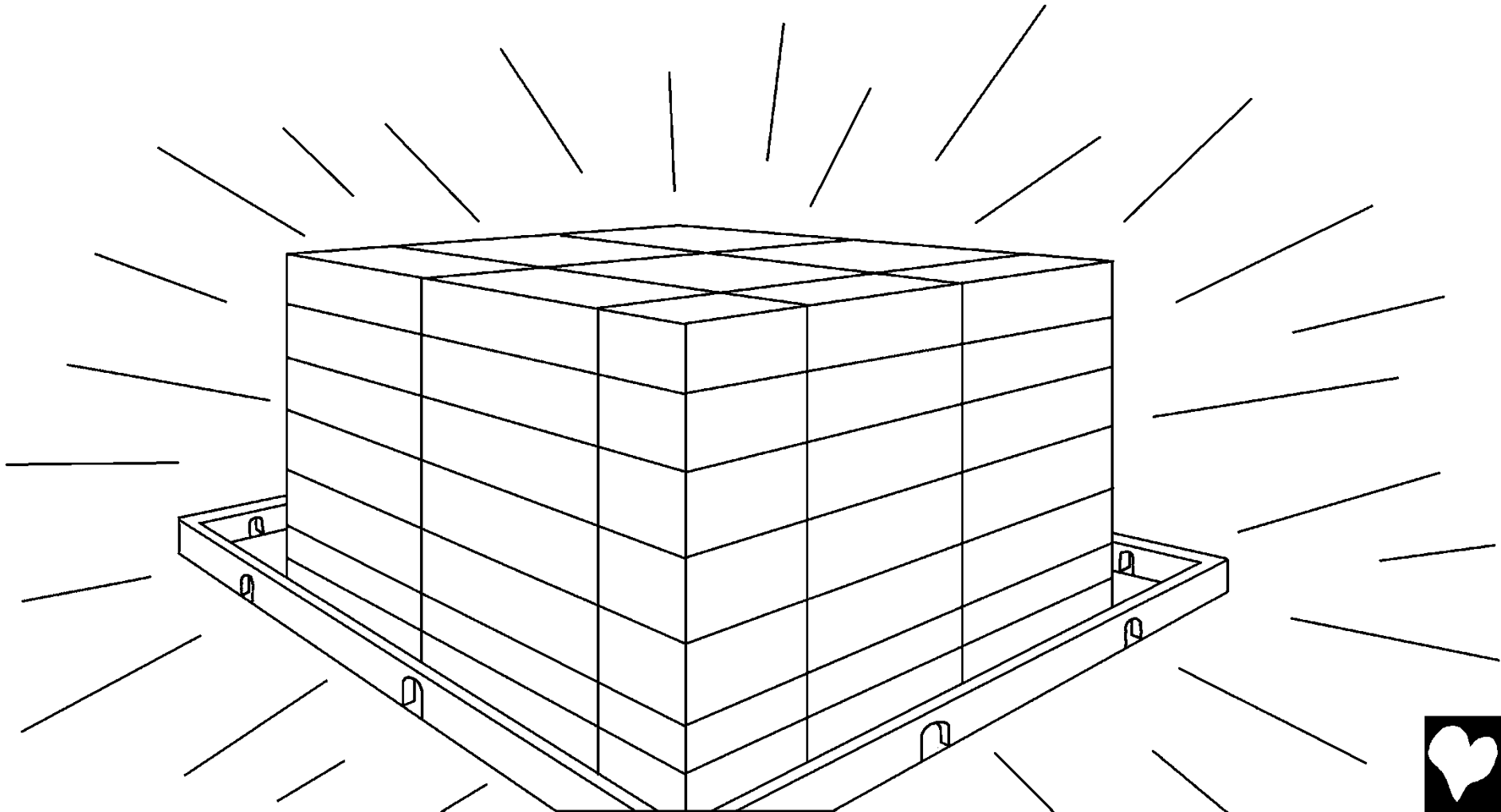

Le dipholologo kwa legodimong di farologane thata. Tsotle di rutilwe sentle ebile di bo tsalano, di ja tlhaga tsotlhe. Le di Tau le tsona di ja jaaka di kgomo. Morena are, "Di ka se senye mothabeng yame e boitshepo".



Ga re lebeletse, re lemoga dilo tse di se yong kwa ledimong. Ga gona mafoko a galifisang. Ga gona motho o o lwang le o mongwe kgotsa o iponang. Ga gona

di notlolo mo me jakong, ka gone ga gona magodu.

Le dinokwane ga di teng. Ga gona sebe kwa legodimong.



Kwa legodimong le  
Modimo ga gona  
dikeledi. Di nako tse  
dingwe, batho ba lela,  
ba utlwile botlhoko  
thata mo bo phelong.  
Mara kwa legodimong,  
Modimo o tla ntsha  
dikeledi tsa bona.



Ga gona leso kwa legodimong gape. Batho ba Modimo batla phela go sa feleng le morena. Ga gona botlhoko, ga gona go lela. Ga gona malwetsi, ga gona menate, ga gona maso.

Mongwe le mongwe  
o itumetse go  
sa feleng le  
Modimo.





Bontle thata ke gore, Legodimo ka la ba simane le ba setsana (le ba bagolo) ba ba dumetseng go Jesu Keresete jaaka morena le mo pholose wa bona ebile ba mo obamela jaaka morena wa bona. Kwa legodimong, gona le buka e e bidiwang buka ya kwana ya bophelo. E tletse ka maina a batho. A o itsi gore ke maina a bo mang a kwetsweng mo bukeng eo? Ke a botho botlhe ba ba beileng Tshepo mo go Jesu. A leina la gago le teng?



Mafoko a bofelo a baibele ke mafoko mantle a go  
memiwa kwa legodimong. "Mowa O boitshepo wa re,  
'Tlayang!' A o o utlwang are 'Tlayang!' A o o  
nyorilweng a tle. Le mongwe le mongwe yo a  
eletsang, a tseye metsi a bophelo  
le fela."



Legodimong, gaeng lere botse la Modimo

Polelo gotswa mo lefokong la Modimo, Baibele,  
e fitlheletswe mo

Johane 14; 2 Bakorinthe 5;  
Tshenolo 4, 21, 22

"Botseno jwa mafoko a gogo bo fa lesadi."  
Pesalome 119:130



Bo khutlo

60

60



Baibele e re bolelela ka Modimo o  
montle o re direleng ebile o batla gore re moitse.

Modimo wa itsi gore re dirile dilo tse disasiamang,  
tseo a dibitsang sebe. Kotlo ya sebe ke lesa, Modimo o go rata  
thata, o rometse morwa wa gagwe a le esi fela, Jesu, gore swela  
sefapanong ka ntlha ya dibe tsa gago. Jesu a phela gape a ya gae  
legodimong! Fa o dumela mo morena Jesu, o mokopa gore a go  
itshwarele dibe tsago, o tla e tsa jalo a phele mo go wena,  
o tla phela le ena go ya bosakhutleng.

Ga o dumela gore se ke nnete, bua se go modimo:  
Morena Jesu, ke a dumela gore o Modimo, wa nna motho o  
swetseng dibe tsa rona, jaanong o phela gape. Ke kopa o tsene  
mo bophelong jwame, o intshwarele dibe tsame, gore ke tle ke  
nne le bophelo jo boshwa, tsatsi le lengwe ke nne le wena  
go ya bosakhutlheng. Nthuse ke go obamele, kotle ke  
go phelele jaaka ngwana wa gago. Amen!

Bala Baibele, o bua le Modimo tsatsi le letsatsi! Johane 3:16

