

የሥራ ለማድረግ ለሌሎች ለሥራ
አዎንታዊ

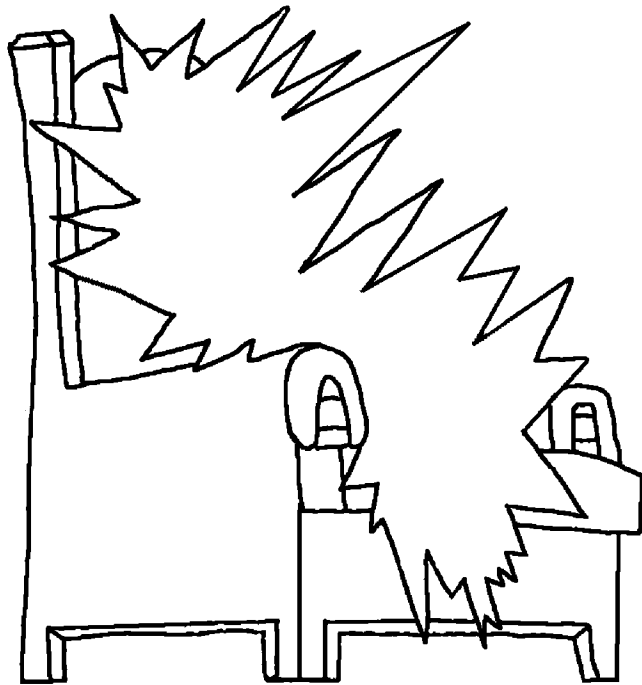

የሥራ ለማድረግ
የሥራ ለማድረግ ለሌሎች ለሥራ
አዎንታዊ



Δ·↳ ΡΛΓαΔ9: Edward Hughes

Δ·↳ ΡΛΓαUΓΓ9: Lazarus
Alastair Paterson

Sarah S.

Δ·↳ ΡΔU·^ηCL9: Bessie McPeck

Δ·↳ Ρ▷ΓC: Bible for Children
www.M1914.org

©2026 Bible for Children, Inc.

CAΓΥ ΓαΛΓα<L^ρ ▷▷∇· <ΓJΔ·^ρ ∇b 5Λd Γ<C<·94^ρ.



רִיבֵי פִּדְיוֹן, "שְׂבִלֵי יִשְׂרָאֵל יִשְׁמְרוּ. וְעַתָּה יִשְׁמְרוּ
יִשְׂרָאֵל יִשְׁמְרוּ, שְׂבִילֵי יִשְׂרָאֵל יִשְׁמְרוּ שְׂבִילֵי יִשְׂרָאֵל יִשְׁמְרוּ."
רִיבֵי וְעַתָּה יִשְׁמְרוּ יִשְׂרָאֵל יִשְׁמְרוּ, וְעַתָּה יִשְׁמְרוּ יִשְׂרָאֵל יִשְׁמְרוּ.
וְעַתָּה יִשְׁמְרוּ יִשְׂרָאֵל יִשְׁמְרוּ, וְעַתָּה יִשְׁמְרוּ יִשְׂרָאֵל יִשְׁמְרוּ.
וְעַתָּה יִשְׁמְרוּ יִשְׂרָאֵל יִשְׁמְרוּ, וְעַתָּה יִשְׁמְרוּ יִשְׂרָאֵל יִשְׁמְרוּ.

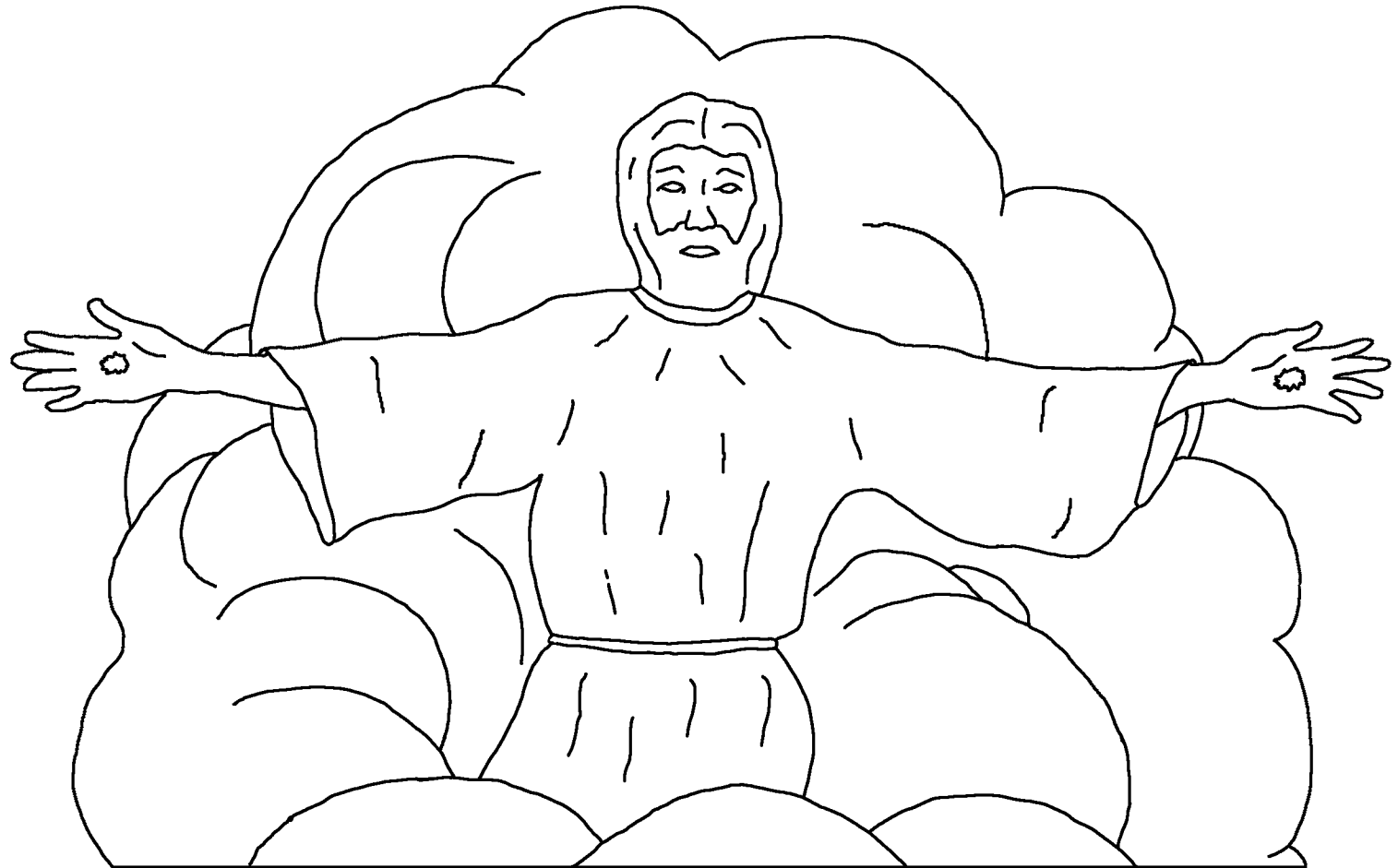

◁Γ ▷Λ▷ βΡΔΥΨ, ▷CΥΓ▷◁· \ β_9▷· \ ρΥ⁰ βΡΔΡ▷- Γ_α
▷Δ· ΛΡ▷- ρ▷CΛσ▷◁· -. ρΥ⁰ ΡΔΡ▷ Δ· <- Λ▷ ▷Λ Γ_α
C C▷ρ▷, Γ_β· - ▷β ▷◁Υ▷◁· Λ▷◁· -. ▷_αC⁰ 9ΔΥ▷◁· -
▷C V· C]· ▷Υ βΡ >σ▷◁Υ▷◁· - βL· 4
C▷ρ· ρΥ⁰? ρρ Lρ_αΔβ▷ ΡΔ· C L▷Γ▷
ΥL· Λ▷ ΔΥ▷◁· \ ρρ ρρ▷· ▷Λ▷
β>σ▷◁Υ▷◁· - ρΔ· ρ▷◁ΥL▷◁· - ρΥ⁰.
▷Λ β_αβC L· ΡΔ· 4Δ· α°
ΥL· Λ▷ βΔ· ρ▷◁ΥL▷
ΡΥLσ▷.

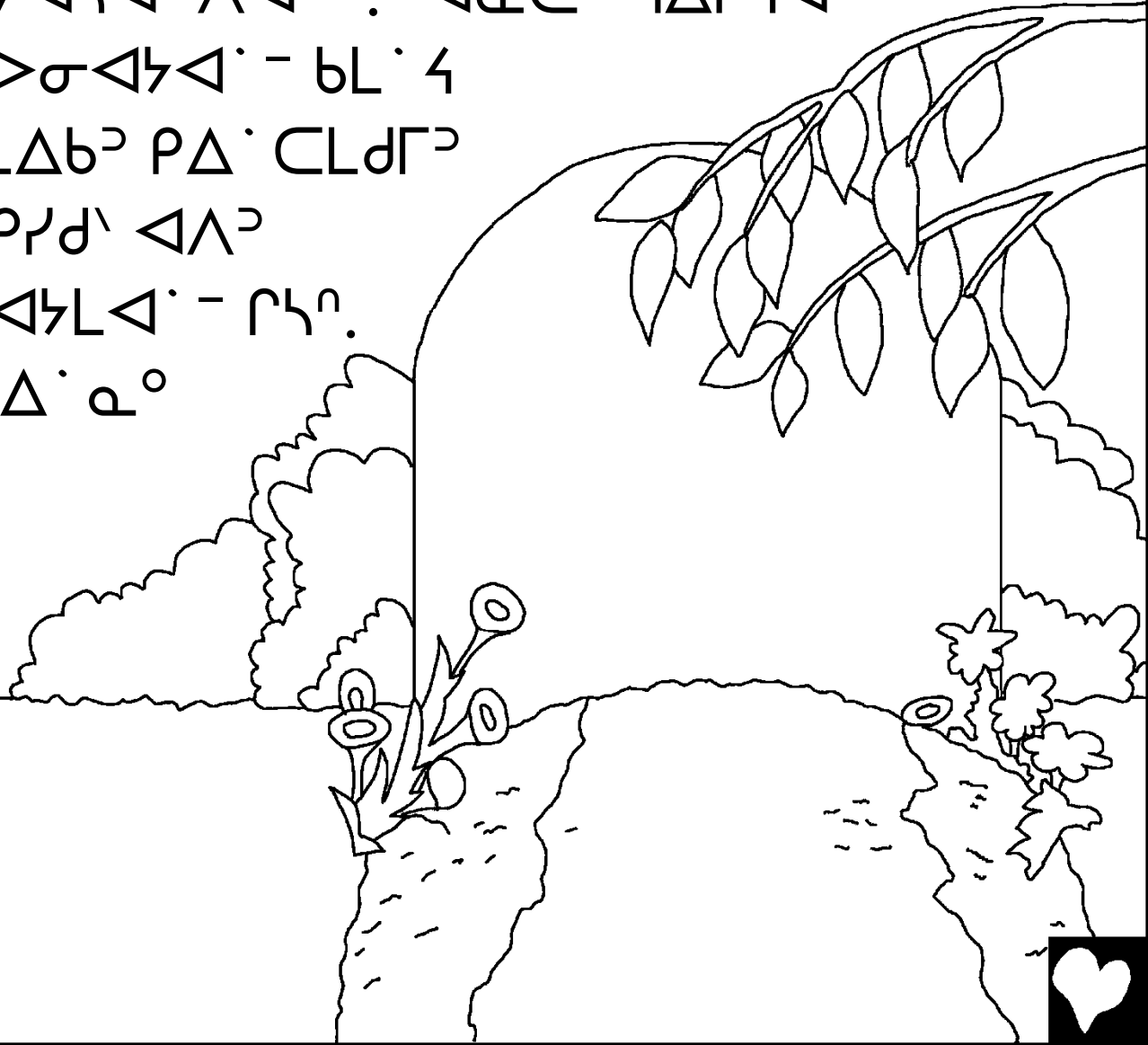

▷Pṽd` Γα Pṽ Pṽd` ◁Δ` ʒ` LGṽL◁` \ PṽLσ▷
Pṽ Pṽd` . ▽b. Γα bPα PṽLσ▷
▷CʒΓ▽◁` \ ◁ḡ bP >σ
◁ʒ◁` - bPα ◁ʒ◁` \
Pṽ Pṽd`. bPα σbJ◁` \ Γα
LGṽL◁` \ PṽLσ▷?

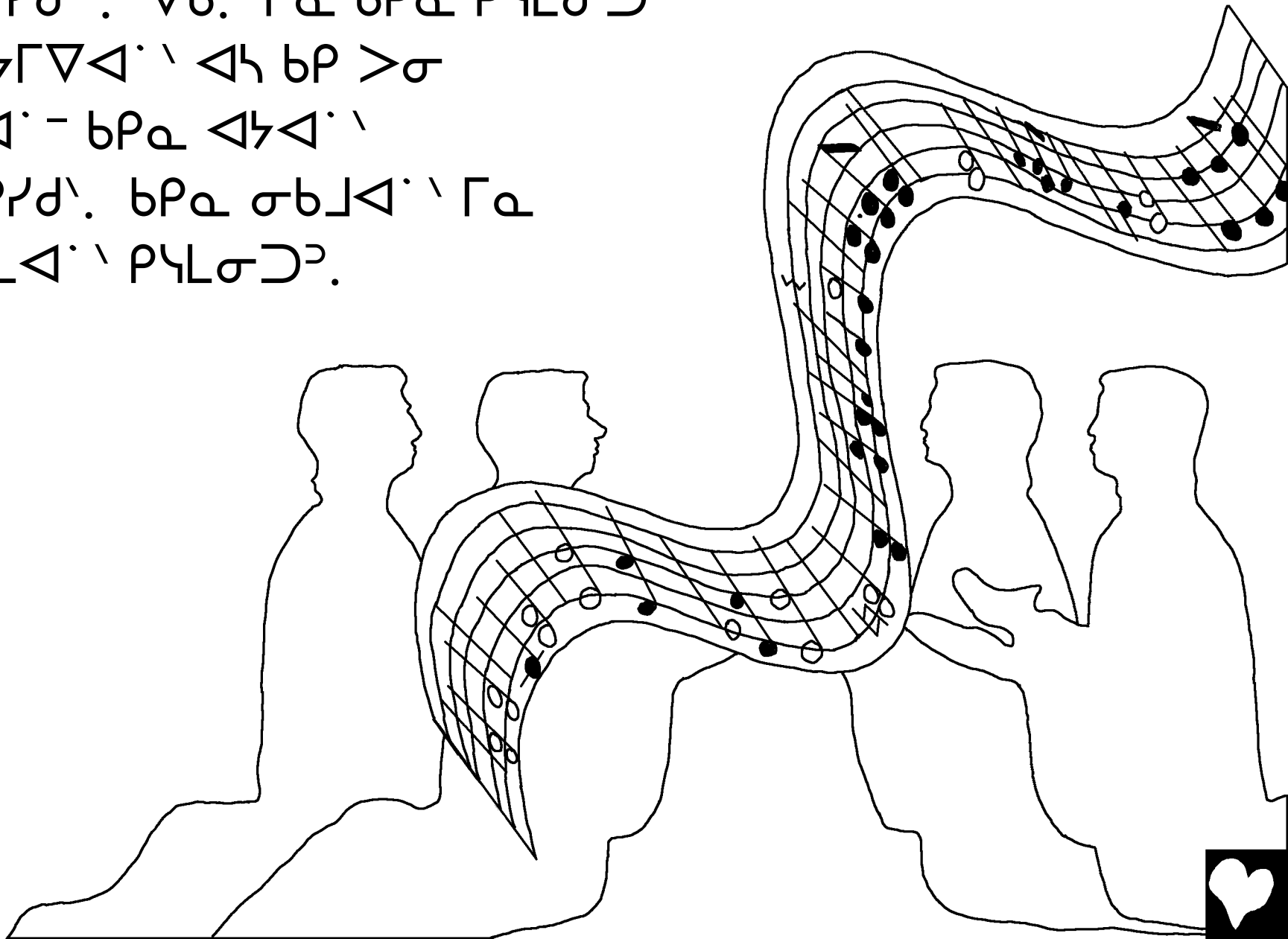

ԲժժԵՆԻՆՆԱԿԱՆ ԲՆԱԿԱՆ ԲՆԱԿԱՆ
ԲՆԱԿԱՆ ԲՆԱԿԱՆ ԲՆԱԿԱՆ ԲՆԱԿԱՆ
ԲՆԱԿԱՆ ԲՆԱԿԱՆ ԲՆԱԿԱՆ ԲՆԱԿԱՆ
ԲՆԱԿԱՆ ԲՆԱԿԱՆ ԲՆԱԿԱՆ ԲՆԱԿԱՆ

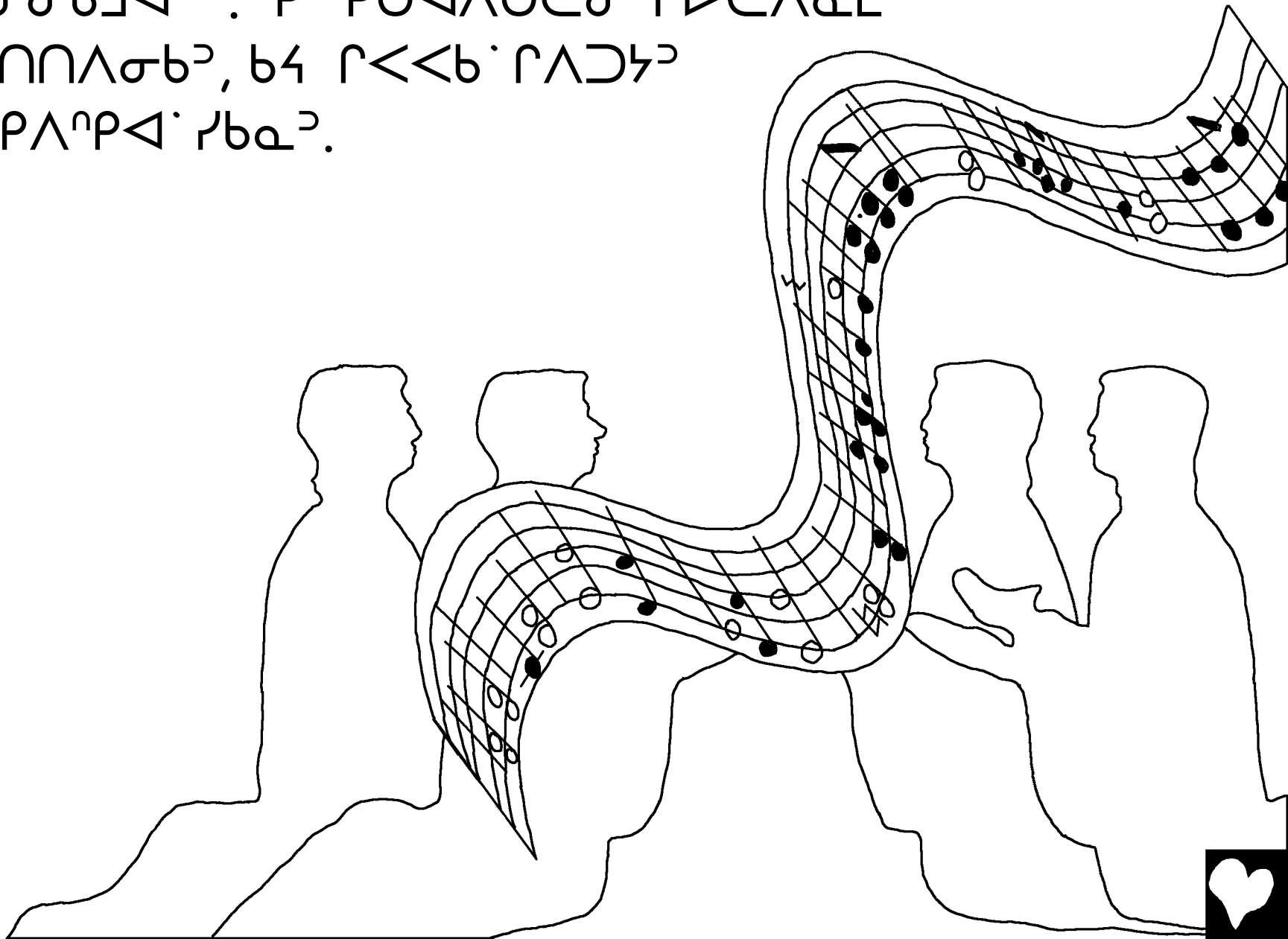

◁σⁿ ρρσγδ, ρΓⁿρ[∘] ΔCⁿ ρρΠ<Δ9CLΔ[∘] \,
ΔΔL Γγ∇[∘] b▷ΓΔ[∘] -, ργLσϷ[∘] ρΠVσΓδΔ[∘] \.
bΡα V<bσργΔ[∘] σ[\], bΡα b4
∇γΔ[∘] Δ[∘] UP[∘] ▷ΓΔ[∘] σ[\], bΡα
b4 V<bϷΔ[∘] αδγΔ[∘] σ[\].
(Ρ9ΓCδ9Δ[∘] [∘] 5:9)

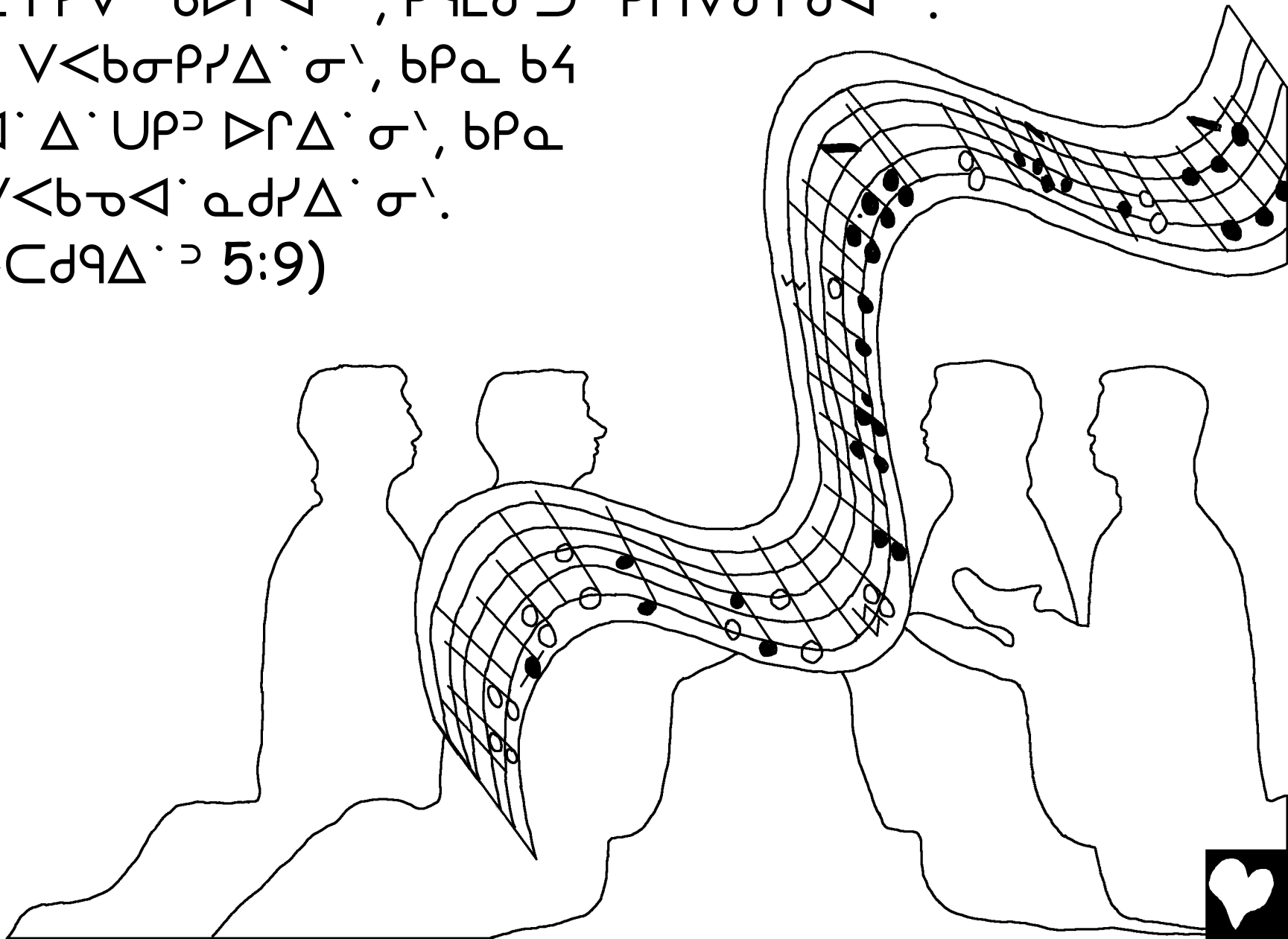

Ἐὰν ἴσῃ ἡ καρδία σου τὸν κύριον, ἡ καρδία σου ἔσται ἡμεῖς. Ἐὰν ἴσῃ ἡ καρδία σου τὸν κύριον, ἡ καρδία σου ἔσται ἡμεῖς. Ἐὰν ἴσῃ ἡ καρδία σου τὸν κύριον, ἡ καρδία σου ἔσται ἡμεῖς. Ἐὰν ἴσῃ ἡ καρδία σου τὸν κύριον, ἡ καρδία σου ἔσται ἡμεῖς.



ბაჲ ბაღღ. ლჲ, რღ. <ცგჲ <ღნ' გღაჲ <ღბ <ღღჲ, რრ რრღ.
 ბღ.ჲ <ღჲ ლრ Δრჯღ.ჲ. ბღ.ჲ <ღღ.ჲ გბრ გა ბღ.ჲ
 <ღღ.ჲ <ღღჲგჲგრ. ბღ.ჲ გა
 რ<ღ^ნბღბუ Δ^ნბ. უღჲ, <ღბ
 <ღღღღ. - ბრღღღღ. - <ღ. ო
 რრ რრღ. ბღ.ჲ <ღღღ.ჲ
 ბრღ^ნრღღ. - , <ღσ<ღღღ. ,
 გუღღ. , გა <ღღ. ლრ
 <ღღღ.ჲ. ბღ.ჲ გღჲ ლრ
 Δღღღ.ჲ <ღჲ რრ რრღ.

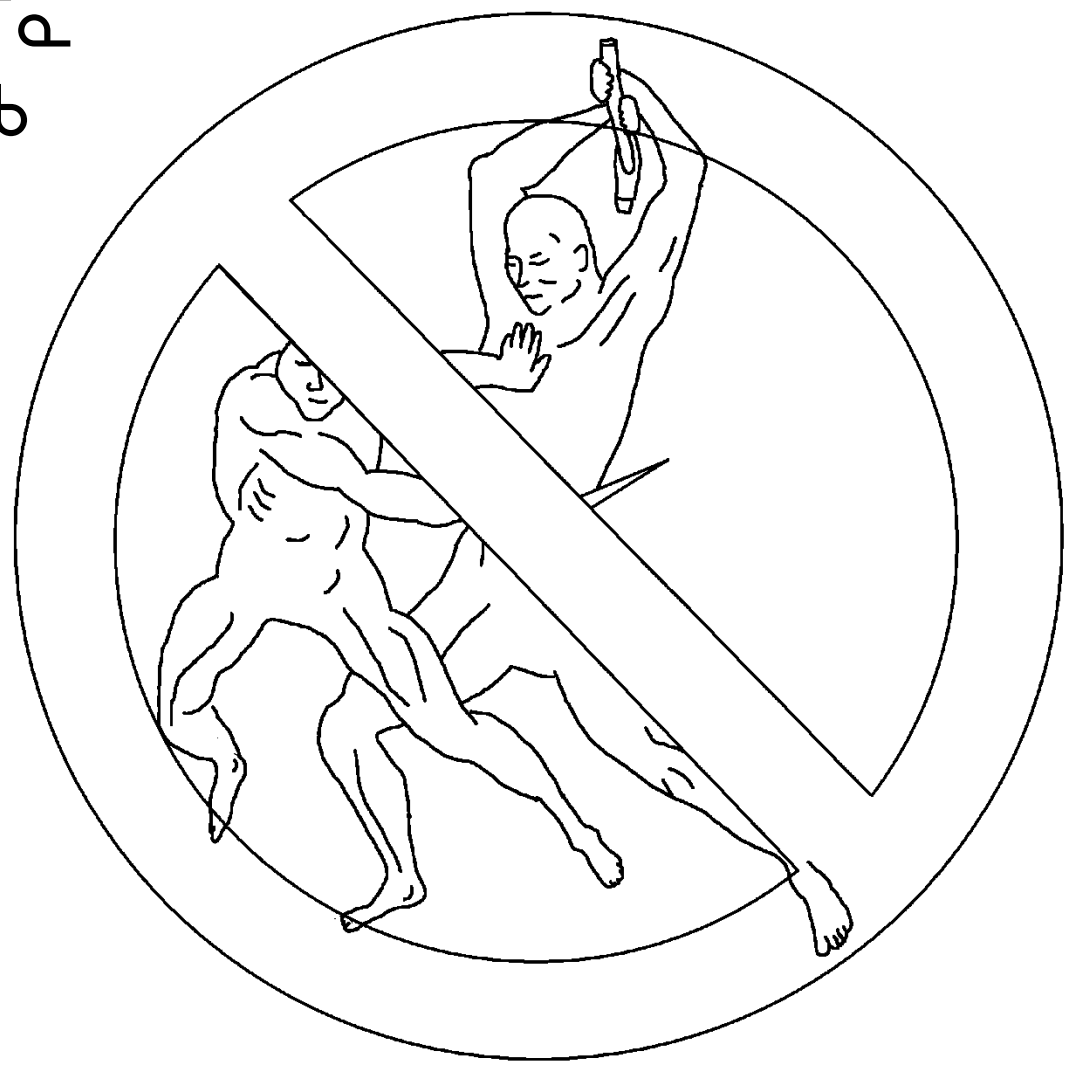

ბა... <... >... ბრ... >... <... >...
... <... >... ბა... <... >...
... <... >... ბა... <... >...
... <... >... ბრ... <... >...
... <... >...
... <... >...



L◁ - P P 9d, P P P d' ◁ b P a e V P H' Γ a Δ n 9' P H'
 (∇ b' Γ a b σ P σ C Δ' P ◁ -) b P a ◁ Δ' H' b C V' C J ◁ - P H'
 ▷ Λ L P Δ ∇' Γ ◁' Γ a ∇ C V' C J ◁ - P Y L σ C ▷ C P L Γ ◁'. P P
 P P d' ◁ b L P a Δ b P ∇ Δ P σ b U' L H N d L P a Δ b P Λ L N P Δ' P.
 b P a ◁ Δ' H' ∇ L P a Δ b P d' -. P P 9 C P a
 ◁ ◁' σ a' b L P a Δ b P d' -? b P a Λ d
 ◁ Δ' H' b P ◁ V σ L ◁ - P H'.
 9 P a P L P a Δ b P P
 ∇' N?

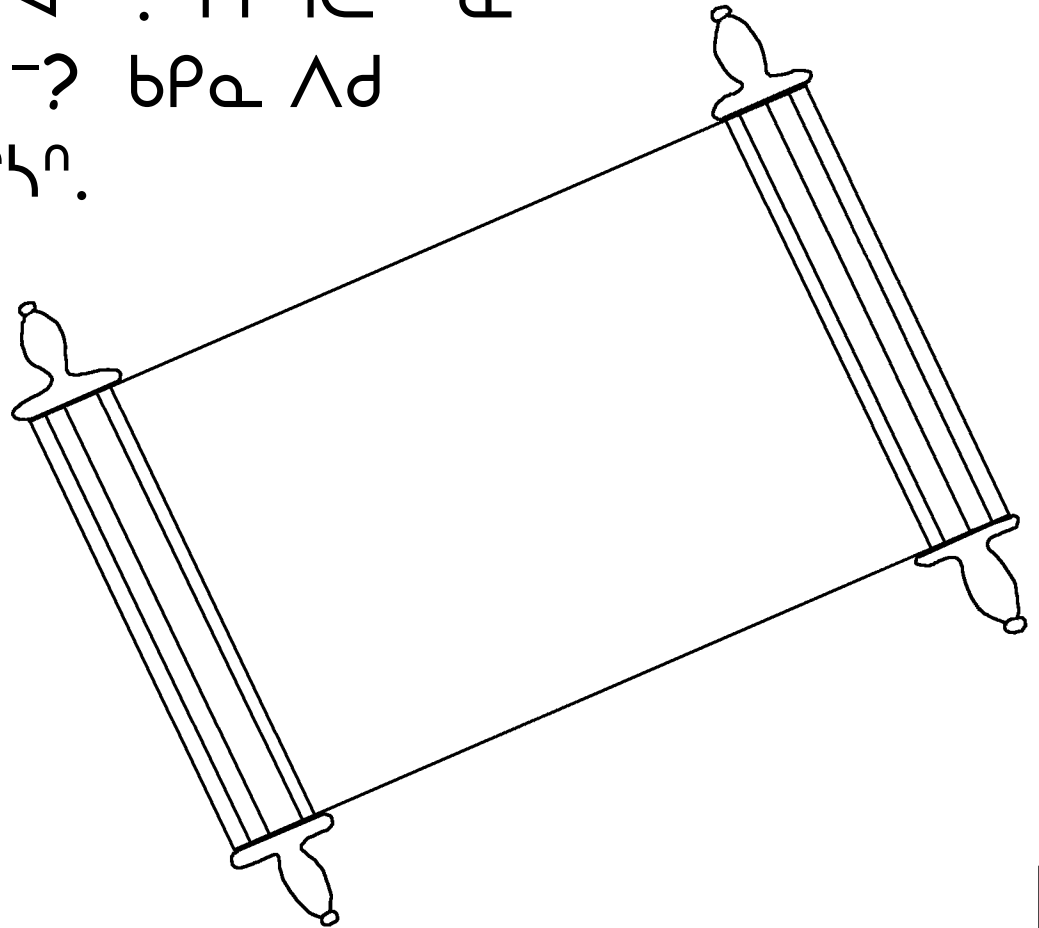

Δ^οβ^ι· ζ^ε- β^ελ^ηρ^αΔ^βυ^α Ρ^ρ λ^ηρ^αΔ^βσ^α Γ^ωσ Γ^α· ρ^ρ β⁹· ρ^ωΔ[·] ρ^ω
Δ^ε ρ^ρ ρ^ρδ^α Δ^ρρ. "β^αρ Δ^β· Γ^α Δ[·] ρ^ωΔ[·] Δ⁹· β⁴ β^ρα
β^ωβ^α· β^αρ^ω β^αβ^ρσ^ρ·!" β⁴ ρ^ρ Δ^ν· β^ωσ^α· ζ^ερ, Δ^ν β⁴ρ,
β^α Δ[·] ζ^ερ Δ^δ β^ωβ^αβ^αβ^α· ζ^ερ, Δ^ν β⁴ρ Δ^δ β^ωβ^αβ^αβ^α· ζ^ερ,
Δ^ν β⁴ρ, β^α Δ[·] ζ^ερ Δ^ββ^α· β⁴ρ Δ^δ Δ^ββ^αβ^αβ^αρ

β^αβ^αβ^αβ^αβ^αβ^α
σ^α.



የሥራ ምዕራፍ፣ የሃይማኖት ልምድ ለገቢ ልማት

የሃይማኖት ልምድ ለሥራ ልማት የሥራ ልማት

የሥራ ልማት

ሥራ 14; 2 ለሥራ ልማት 5;

የሥራ ልማት 4, 21, 22

"ሥራ ለሥራ ልማት ሥራ ልማት ለሥራ ልማት."

Psalm 119:130



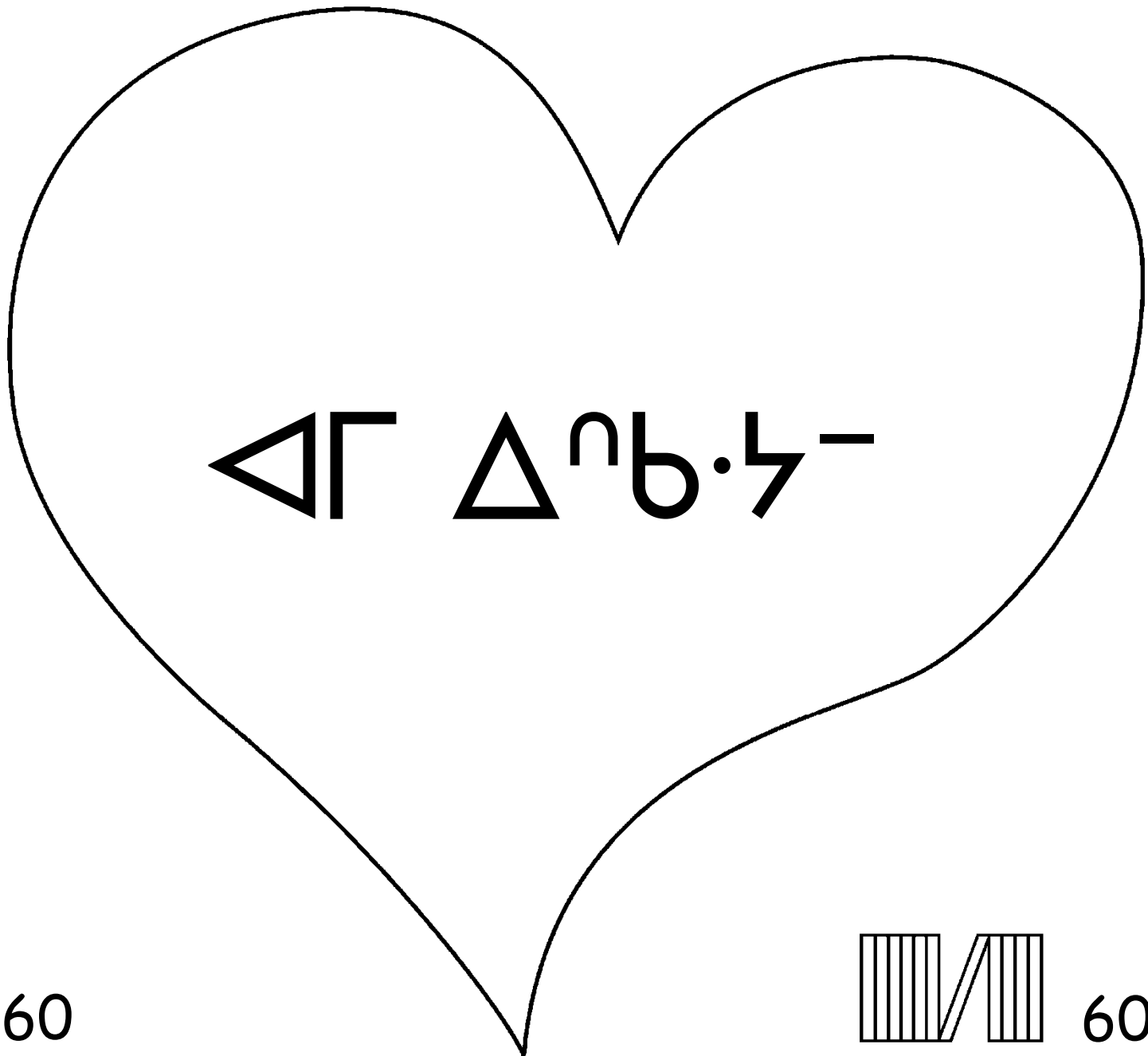

60

60



የቦ ሊኖረዎት ማረጋገጥ ለሌሎች ምሥጢር
በሆኑት ሁኔታዎች ማረጋገጥ ለሌሎች ምሥጢር .

የሆኑት ምሥጢር ማረጋገጥ ለሌሎች ምሥጢር , ማረጋገጥ ለሌሎች ምሥጢር . ለሌሎች ምሥጢር
ርዕይ , ለሌሎች ምሥጢር ማረጋገጥ ለሌሎች ምሥጢር , ለሌሎች ምሥጢር ማረጋገጥ ለሌሎች ምሥጢር ,
የሆኑት ምሥጢር ማረጋገጥ ለሌሎች ምሥጢር , ለሌሎች ምሥጢር ማረጋገጥ ለሌሎች ምሥጢር . ለሌሎች ምሥጢር
የሆኑት ምሥጢር ማረጋገጥ ለሌሎች ምሥጢር , ለሌሎች ምሥጢር ማረጋገጥ ለሌሎች ምሥጢር ,
ለሌሎች ምሥጢር ማረጋገጥ ለሌሎች ምሥጢር , ለሌሎች ምሥጢር ማረጋገጥ ለሌሎች ምሥጢር .
ለሌሎች ምሥጢር ማረጋገጥ ለሌሎች ምሥጢር .

የሆኑት ምሥጢር ማረጋገጥ ለሌሎች ምሥጢር , ለሌሎች ምሥጢር ማረጋገጥ ለሌሎች ምሥጢር ;
በሆኑት ሁኔታዎች ማረጋገጥ ለሌሎች ምሥጢር , ለሌሎች ምሥጢር ማረጋገጥ ለሌሎች ምሥጢር .
ለሌሎች ምሥጢር ማረጋገጥ ለሌሎች ምሥጢር . ለሌሎች ምሥጢር ማረጋገጥ ለሌሎች ምሥጢር .
ለሌሎች ምሥጢር ማረጋገጥ ለሌሎች ምሥጢር . ለሌሎች ምሥጢር ማረጋገጥ ለሌሎች ምሥጢር .
ለሌሎች ምሥጢር ማረጋገጥ ለሌሎች ምሥጢር . ለሌሎች ምሥጢር ማረጋገጥ ለሌሎች ምሥጢር .
ለሌሎች ምሥጢር ማረጋገጥ ለሌሎች ምሥጢር . ለሌሎች ምሥጢር ማረጋገጥ ለሌሎች ምሥጢር .

ለሌሎች ምሥጢር ማረጋገጥ ለሌሎች ምሥጢር ለሌሎች ምሥጢር ማረጋገጥ ለሌሎች ምሥጢር . ለሌሎች ምሥጢር ማረጋገጥ ለሌሎች ምሥጢር .

