

www.BibleForChildren.org

Jon 14

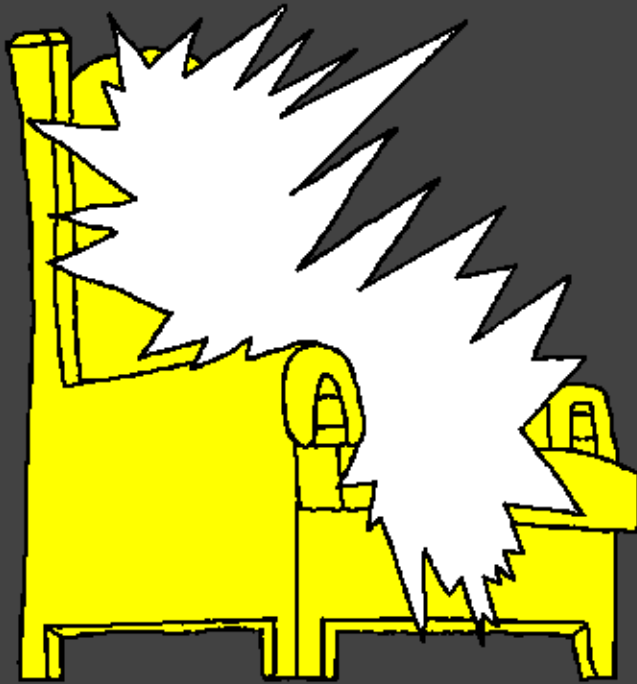

Jisas oh Gur gin dir kinhatiprohe sa daham da tupnet rim heimse ritipri. Gotsi; Jisas ihit taman yah matwi napaptiwa dahatwi patenmur. At ohe pat tei oh gure indin tei oh ruumsan patmur. Ihat na patneng noh rih orhor gure indin tei oh ti na patmur napotipneng basda.



Ihat pat ohoh ihan noh gure paten tei napomtinmat
saprohmur. Susa paten tei napomara it apris gurnong
nambura napisusa nohe ma patepra tei oh diradir tap
hat pateprimur.



Noh guragure nita Jon noh brak mat mama nasar
ohmur. Diradir Jisas ohe nita bap dir Got orhe
napapindin hrepnong hat pati bap dirmur.

Ama ihat pati han dirnong be
han ihirdapat Jisas ohe



nita hat pati han
bap ma hapat daham
ina ruumsup
napriptimur.



Ina ruumsup diradir titwi daripti han dirmur. Ina ruumsup napriпти orhor Jisas orhe tapnong hat pati ohoh ihan dir na gapa ham kasip hat

orhorwi saptimur. Noh Got ohe mengsi;
Jisas ohe arpin meng ma



napor mengsi pot
pisapatin ama ohe pe
oh ihir nohnong
inahama tom goh

Patmos mongnongnang
natpam namdatpamur.



Napotporhan Got orhe Yahsup oh nohe mutuh isip
naham kasip nahama kapkap orhor nohnong it
nambura naprungop. Napruporhan noh watahahoh aw
tei mahat pat has ringop. Aw tei mahat pathe daham
wandeioh kakhan hama ohe tongnom
ihirong wamat papat ap tan
oh pat hangop. Pathan
ama ap tan tei oh
han tit tongnot
patgop.

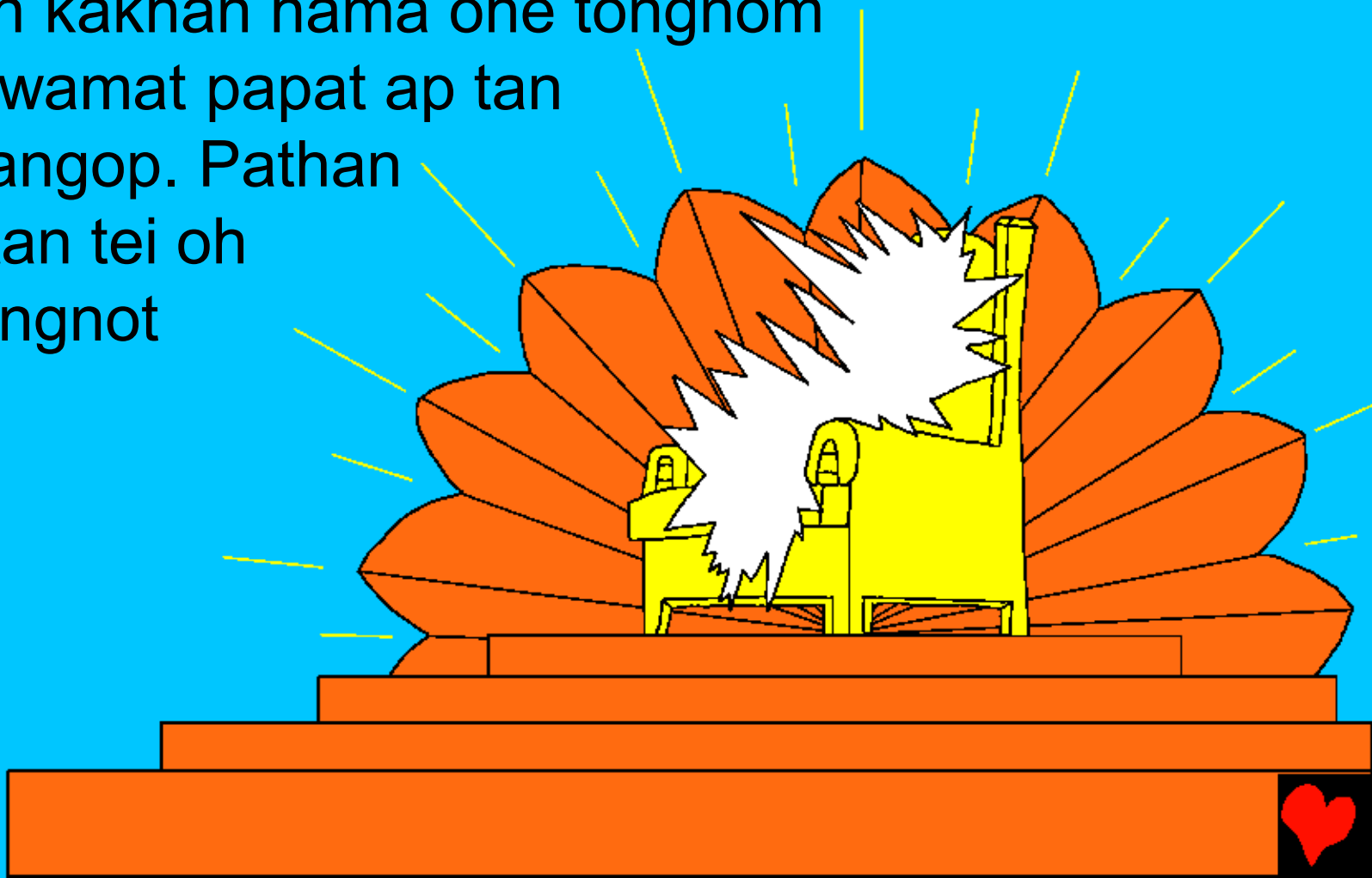

Gahan noh amraoh Got ohe ma dasi matip erer oh aw
tei mahat Got ohsi pati ohe dasi erero mong tei moh
ohe dasi erero mong hrep ohe dasi
erero tom hru tem dasi erero oh
gonsi gon ihitnongwi armi mar ga
poriptingopa. Ga ma potpa ga oh
mamaru hat patmur. Mutuh ap tan
ma tongnot pat
hansi sipsip bap
ihitnongmura;
ihitnongmura.

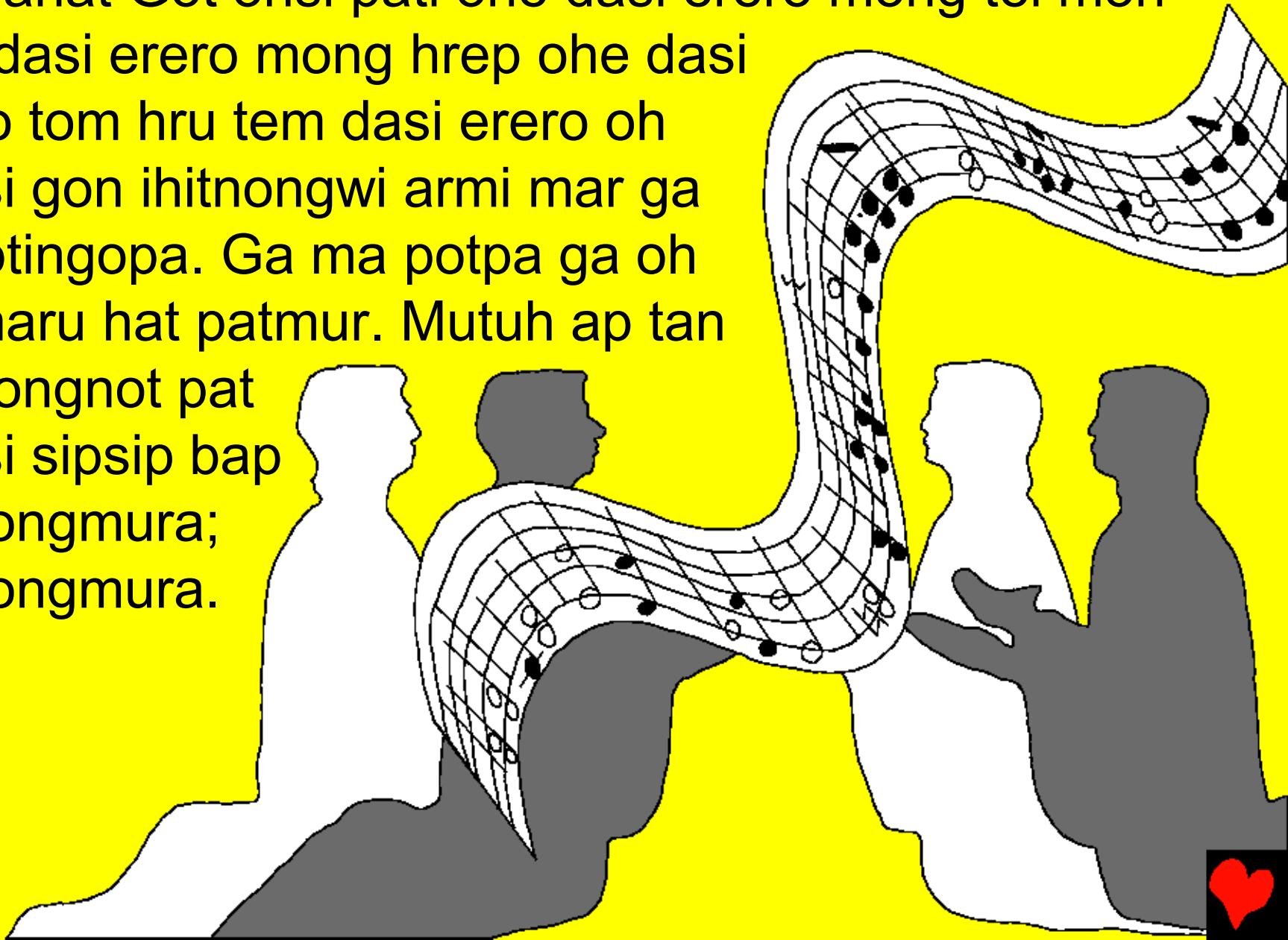

Ihitnongwi winsi matin hanmura; winsi matin hanmura.
Ihitnongwi has yahnapsi hanmuro
porin hanmura; porin hanmura.
Ihitnongwi kasipnap hanmuro
porin hanmura; porin hanmura.
Ihitnongwi ihtin han ohoh ihan
ihitnongwi eimat armi mar
papteprimura;
papteprimura
por ga
poriptingopa.



Tarpatperhan noh it wandeioh awam ongeng mat papat ap mutuh kopenohe Jerusarem ap mutuh oh aw tei mahat Got ohsi patdapat wanpatgop. Kuu ire han datperim ma awat tahaptiru hat awat yahnep tit ara wanpatgop. Wanporhan noh amraoh orhe pohon

tongnopat bas amdapat kasip mengtei We. Gur gin amratinmuro. Gin Got ohe ma patepra oh orhe kuuhan ire mutuh oh patepramuro.

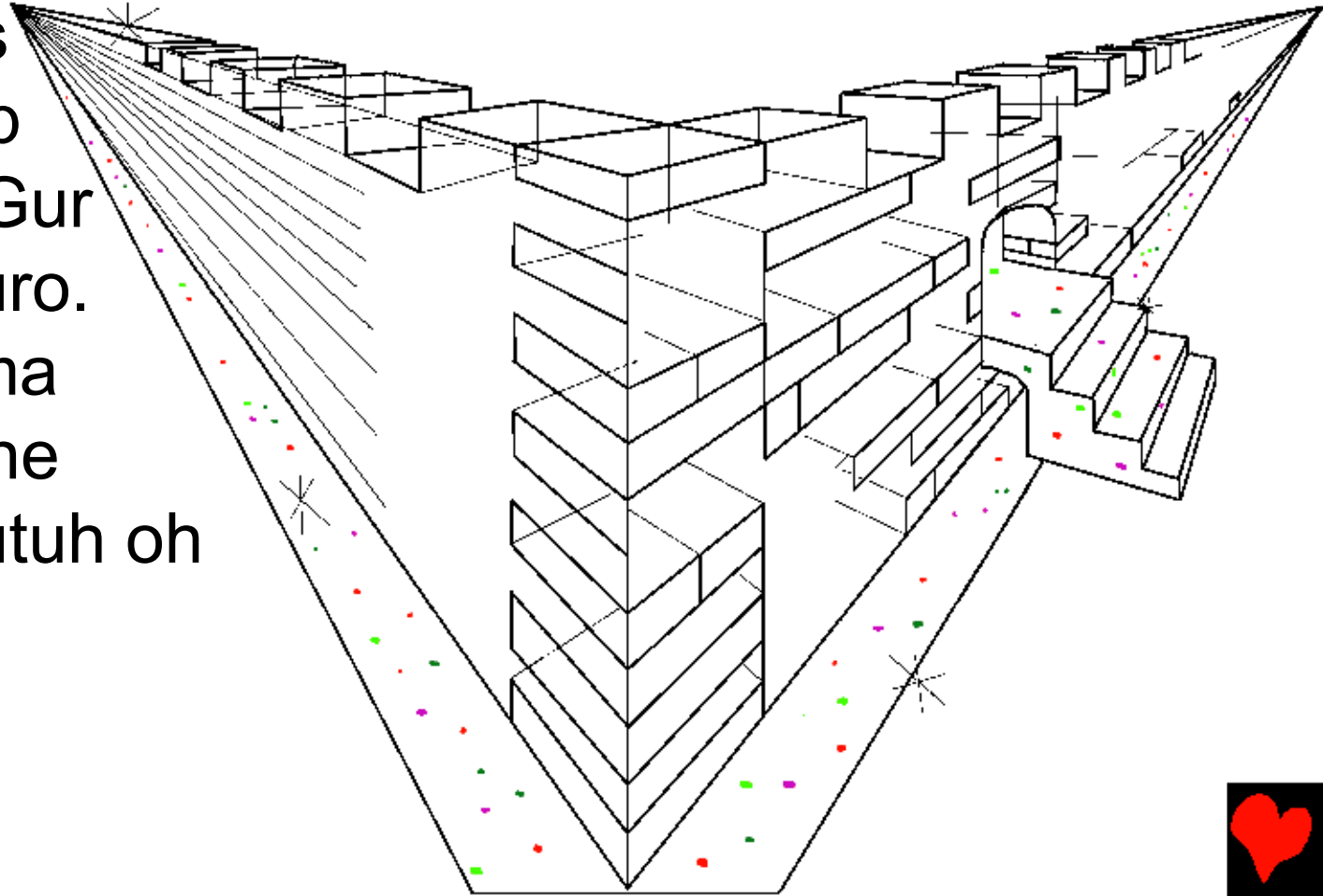

Oh ihat patin ihirhe orhe nita bap kuu han ham
pateprimuro. Arpin napormuro. Got orhorsis; orhe nita
kuuhan ihirsi tap hat pateprimuro.

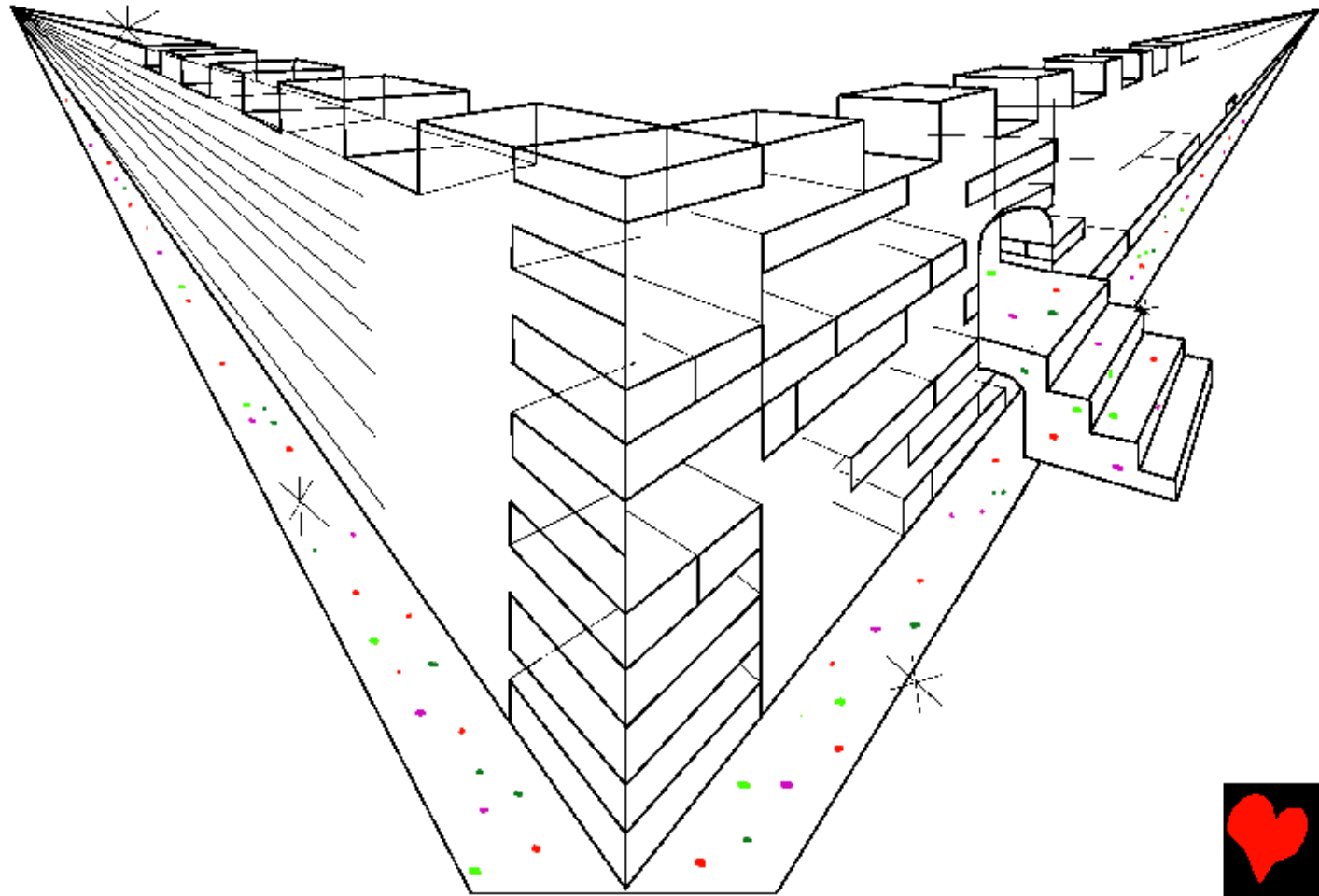

Gahan enser oh tom tit dama eimat paten dasi hatin
ohe tom tit Jon nohnong namgingop. Ama tom oh Gotsi
sipsip bap itaite pohon tongnopti tei duupdatapat marasa
kakeirsi hasnap tom apripatgop.

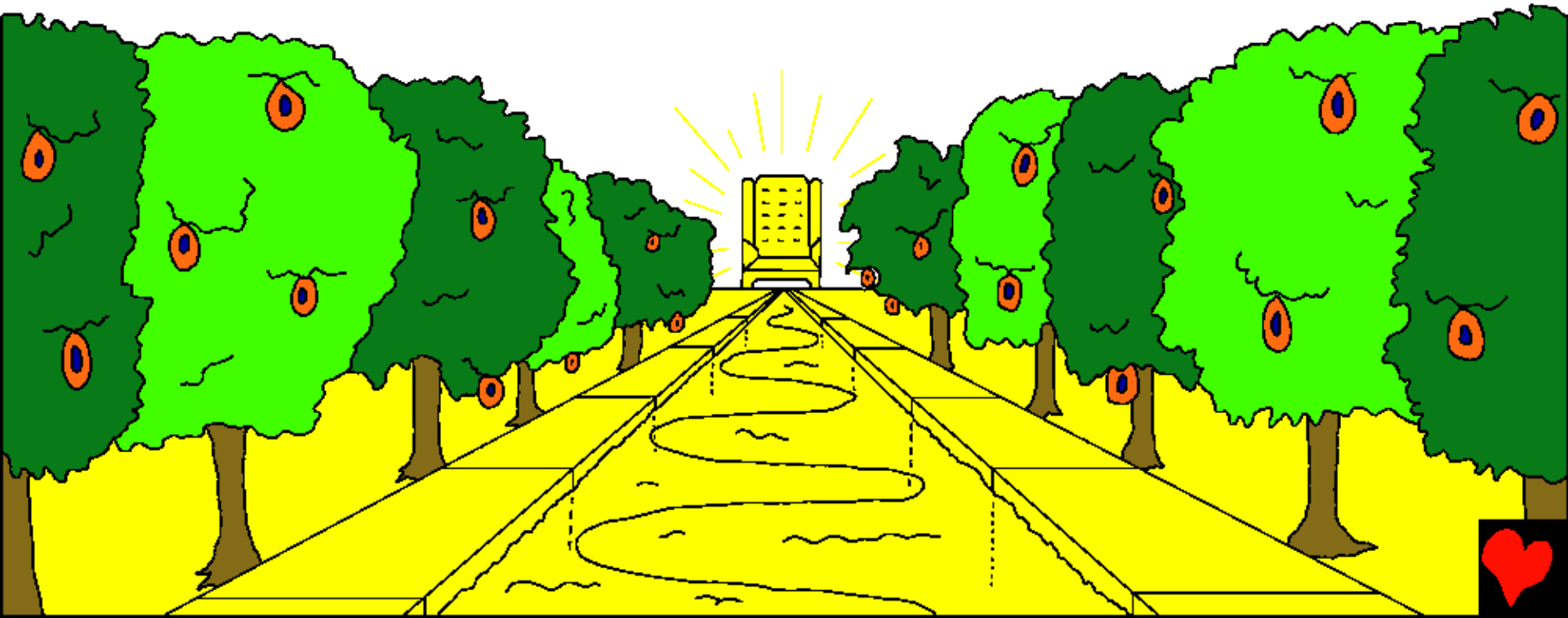

Ama ap mutuh ohe hashe Got orhe has oh atan hatin
heiro sipsip bap ohe has oh tanggam has hatin heiro
hat papti ohoh ihan atano hayopo ire has oh timbas
ham ti na pati hangopa.

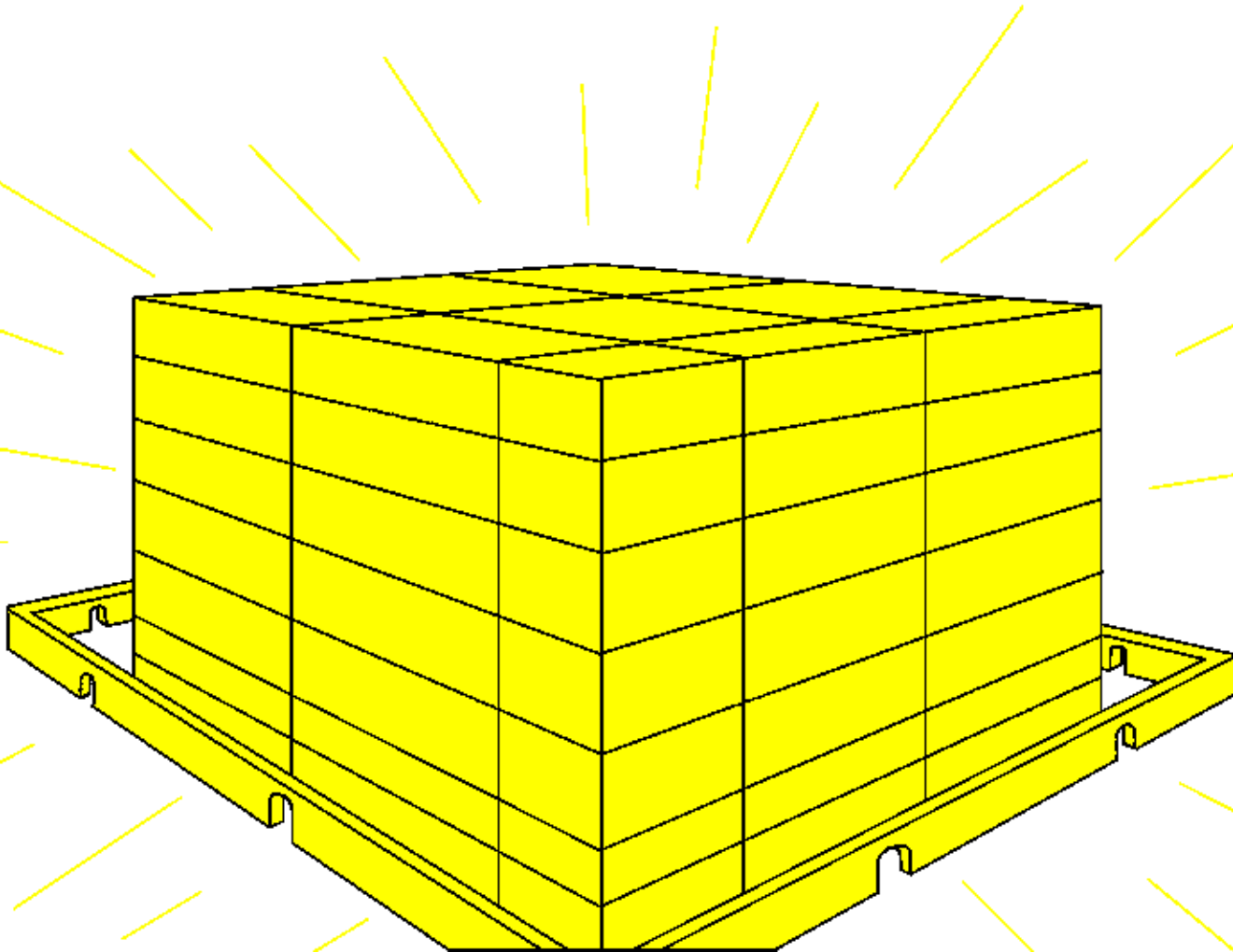

Yah erer oh poprisiprimura; ongeng tahat na pati hano bisei hapti hano dasuh hapti hano ama ihapti han ihir ama ap mutuhnong oh na rosiprimur. Sipsip bap orhe eimat paten ohe brak teinong win ma atip bap ihirwi rosiprimur.



Ihat tap hat patema kin tom oh
agatmatipramuro. Agatmara rihohe ma
ihapti erer oh timbas hah ohoh ihan
haputin dao saheih ham yimapti dao
batbet hapti dao oh gonsi timbas
hatipramuro rim hangop.



Ama ap mutuhnong oh Got oh na bopor mara heisup
mat papat han erer oh ama ap mutuhnong oh ham
eimat na patepramur. Gotsi sipsip bap itaite pohon
tongnopti tei oh tongnot patin Got orhe atamreipti han
bap ihir orhe danong
hama armi mar
papteprimur. Ihir
orhe win oh ire kinbi
tei patin orhornong
wamaro armi
maro haprimur.

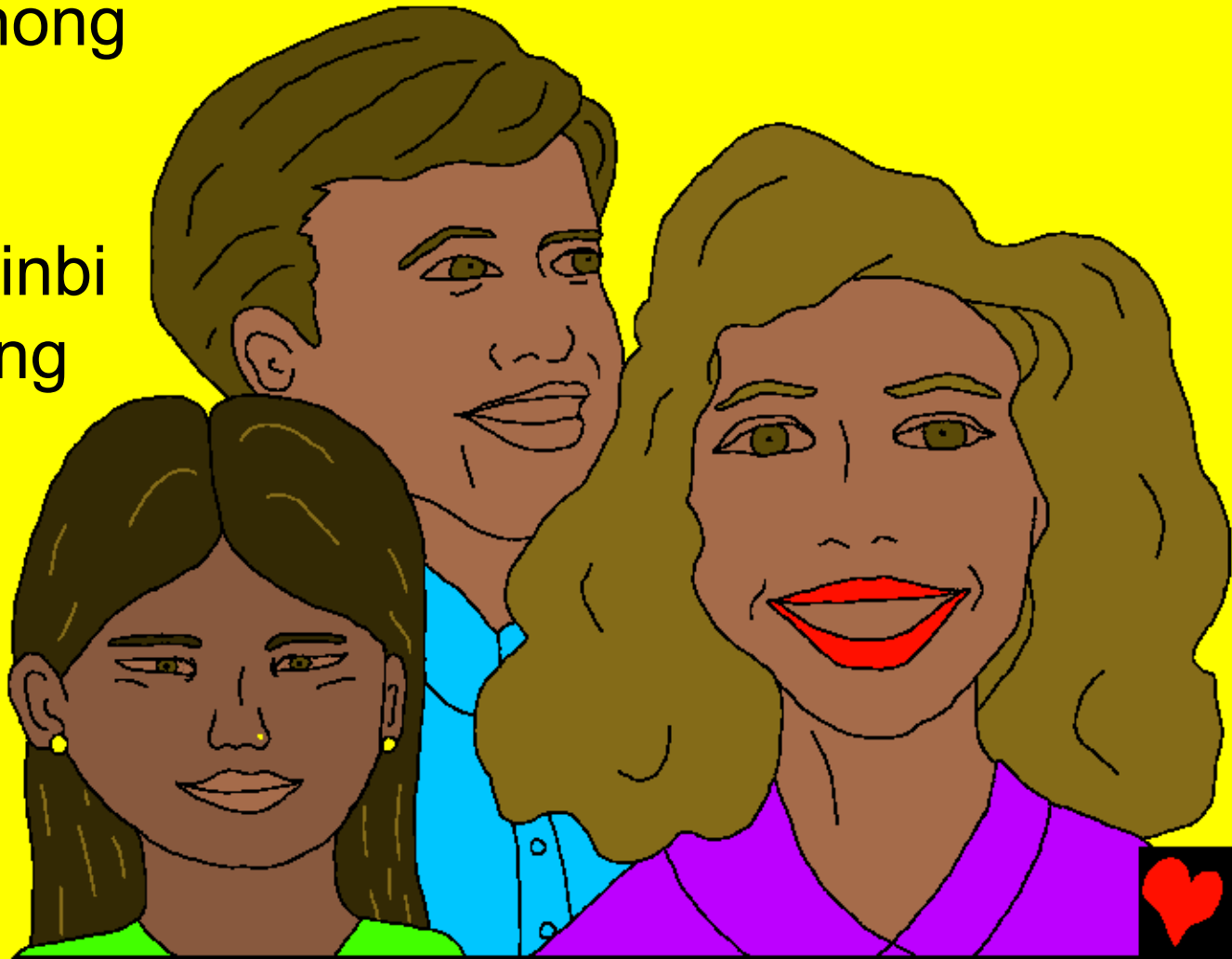

Timbas hatporhan gahan noh it wandeioh han kamah
winsi hat pateshe hano borop win timbas hat pateshe
hano ama haputpa han ire da bap oh er dasi; yah dasi
gonsi gon orhe tongnot pat rum dason oh tandeit
patingopa. Ihir ihat tandeit patina tit
brak ban oh meng eimat paten dasi
ohe brak oh dapengopa; ti brak
ban ma dape oh hanip
iraire ma ihat sashe
ohe meng brak ban
oh dapengop.

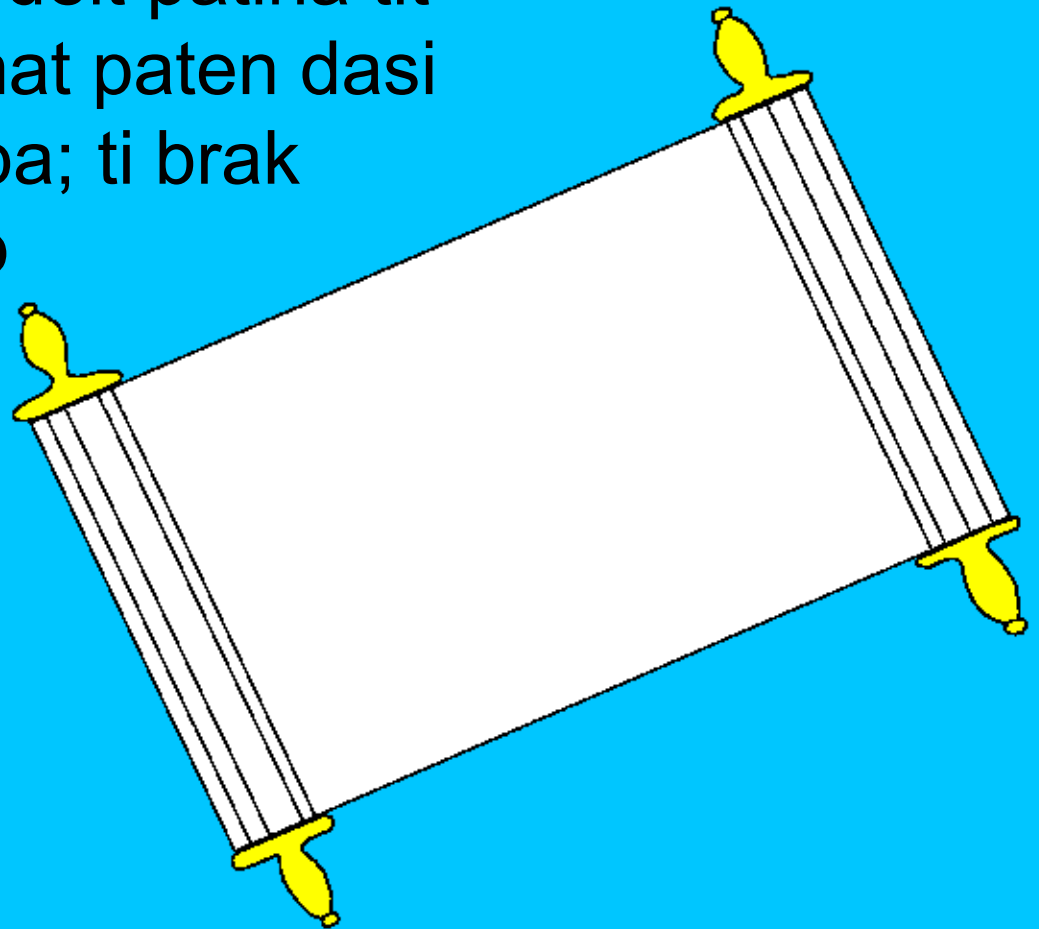

Dapema sama iraire ma ihashe oh Hanipyah oh brak
teinong ma matip meng oh wamara ama meng ohe kis
yan orhorwi apingop. Mandapat eimat paten ohe brak
matip tei oh ire win ma na brak matip ihir ama win
timbang ihirnonghe tahe pora ama irat
taurpat tanggap isip dahnong
ohom tihi tahe por
mandangop.

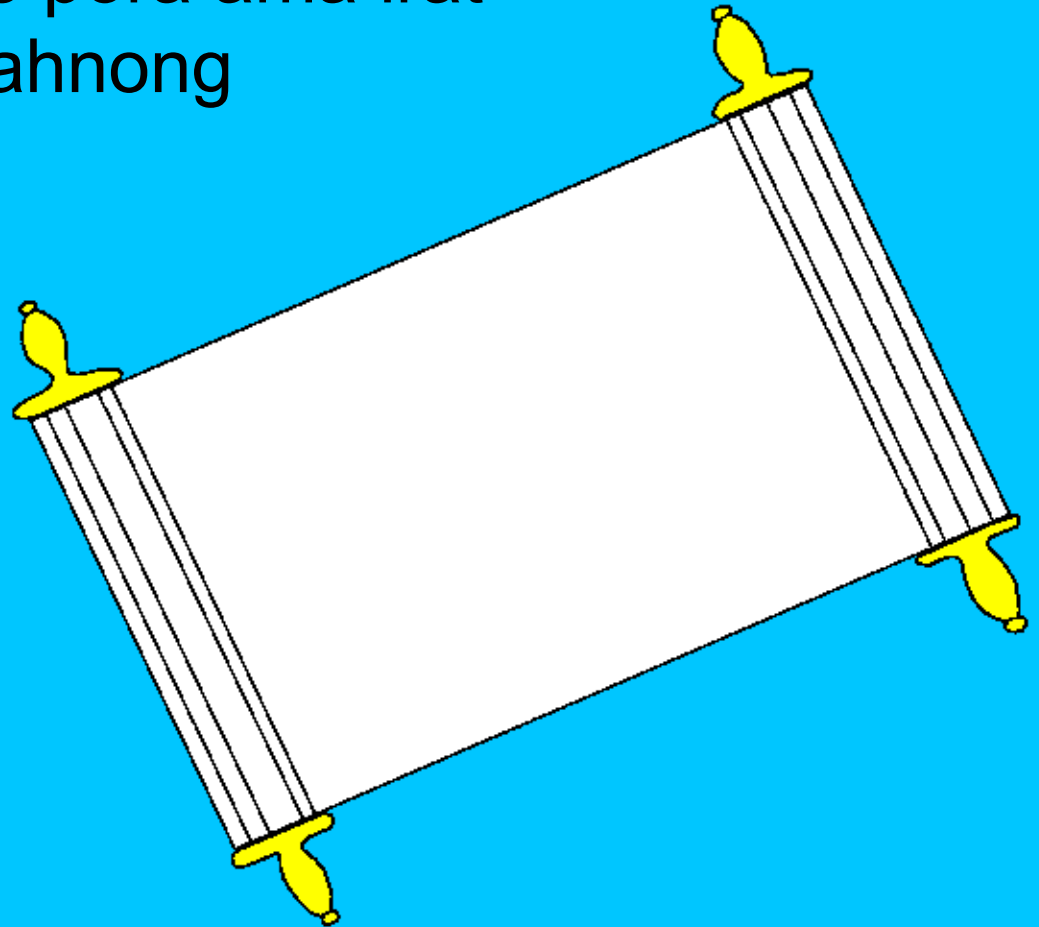

Got ohe Yahsup ohsi; sipsip bap ohe kopen ma dat kuu
ihitdapat dirnong Guragur sipsip bap ohnong Gin go
aprina porinmur. Potperhan ama amraya kuuhan gurhe
tap meng amaru mat orhor Aprina porinmur.

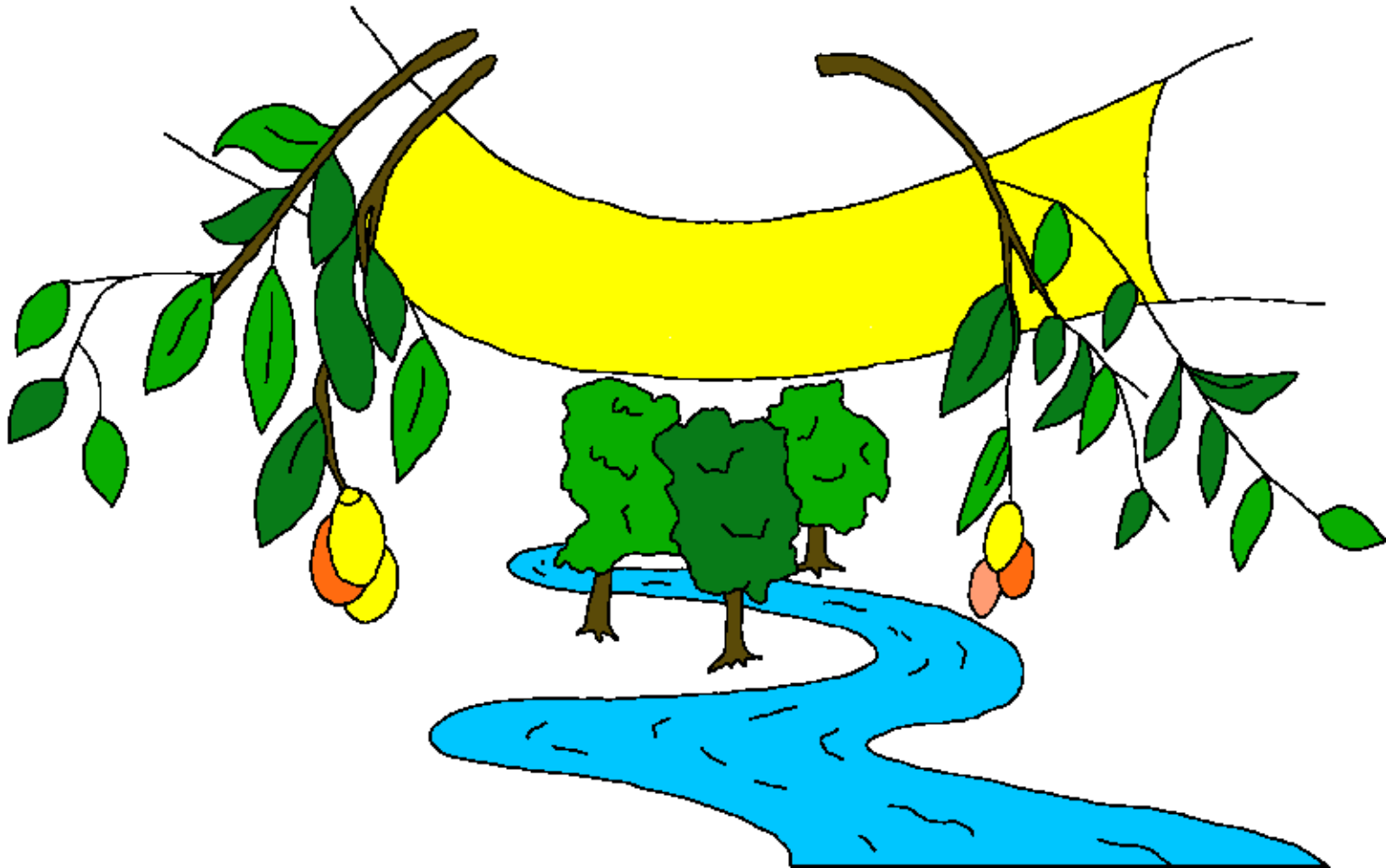

Ama giporipti han bap gur tom din ham dipera
dahaptihanhe apris mama tom eimat paten dasi hen
ohe tom oh yan timbas be napin tom ohoh ihan apris be
daprimur.

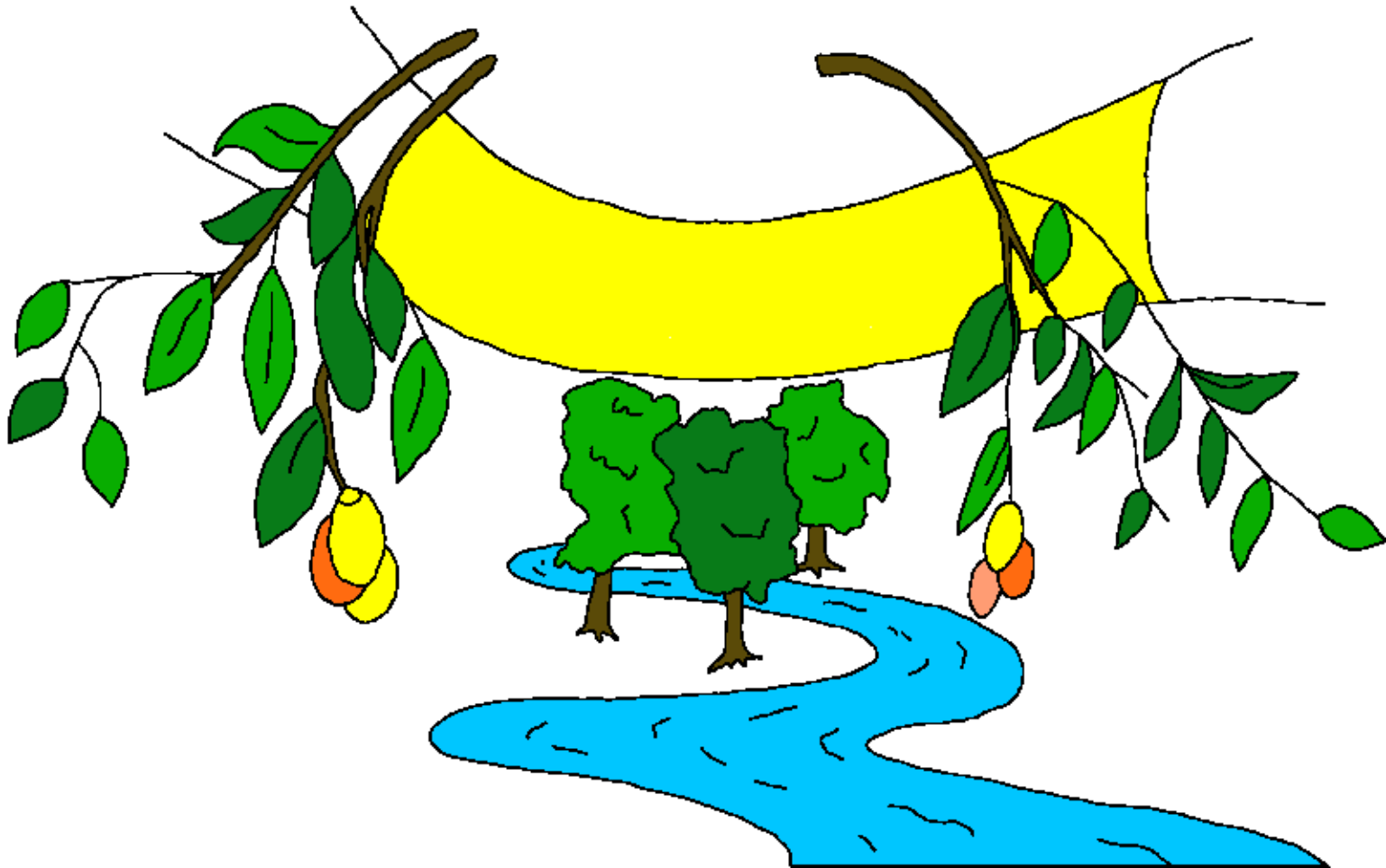

Got oh kakdah han gurnong ruumsan
bopor nahat napapat ohoh ihan oh
Norhe brer tit pokwi oh ire gwemat
adarhetporhan ihir Ohwi inahatin
hatin hanwa dahayahanoh
ama . . .



. . . ihat dahaya han ihir na hapura
nohsi eimat yah hat paten dasi hat
patepriwa daham gure gwemat orhe
brer tit pokwi nohnong
nadarhetipmur.



Rom 3:22,23 Ama kat oh mamarumur. Jisas Kraiss ohe danong ham Ohwi inahatin hatin hanwa dahatperhanwi Got oh Gur yah hat pati bapmur naporpatmur. Juda bapo Juda na hat pati han bapo diradir gonsi Got ohe kintei er hat susa orhe amam nahatin ohe yah danong akap mar ihat saptimur. Diradir tap hat gonsi dir ihat pati ohoh ihan dirnong Gur yah hanmur napotin kat oh tit Juda bap irarhemur. Tit Juda na hat pati han bap irarhemur napotin kat oh yot kathe ti na patmur. Diradir tap hat er hat pati bap dir ohoh ihan tit kat pokwi hat patwimur.

Rom 6:23 Er da hrepdapat hat patim er hat ma sapti han ihirnong er yan ma apripra oh hapura dipwi batbet dar patepri apteinong matipramur. Got orhe damdapat Gin yan timbas be musum yahnep han tit apripora daham ma napripra yah yanhe diradire Hanipyah Jisas Kraiss ohe tapnong hat pati dirnong oh eimat yah hat paten ohe yah yan oh napripramur.



Hibru 9:27 Hanip dire tit dahwi ma hapuriptinong oh dahrenmur. Hanip dir tit dah pokwi hapur saperhan dahanahatin inasi hat pati ohoh ihan Got orhe dahanahatipra tei oh dahanahatipramur.

Epesas 2:8,9 Ama orhe damdapat Yah matpora daham ma namgitip da ohsi namburpatmur. Hanip dirardire kasip hat saya ohe peo yah hat saya ohe peo ama ihat saya ohe pe oh Got oh na namburpatmur. Ohwi inahatin hatin hanwa dahatperhan orhe damdapat Noh ihirnong imat yah mar ambutpora dahapat da ohsi dirnong namburpatmur. Imat dirnong namburpat ohoh ihan dir kinhat dirardire yah hat saya ohe pe nambur napapatmur rim armi tahatiprohe. Ihat armi tahatin da oh timbasmur.



Rom 10:9,10 Ihan gur damdapat Got oh Kraiss ohnong arpin pamsuhup han ma hapat dahama atem teimdapat Jisas oh norhe Hanipyahnap hat pat hanmur riyahanoh ama ihat daham giriya han gurnong oh Got oh nambutin han naham nambutipramur. Damdapat Got oh Kraiss ohnong arpin pamsuhup han ma hapat dahatperhan Got oh Gur yah hanmur naporpatmur. Atem teimdapat orhornong dahapti da oh pitap teinong matperhan nambutin inasi naham nambur napapatmur.



Jon 3:16,17 Got oh kakdah han gurnong ruumsan bopor
nahat napapat ohoh ihan oh Norhe brer tit pokwi oh ire
gwemat adarhetporhan ihir Ohwi inahatin hatin hanwa
dahayahanoh ama ihat dahaya han ihir na hapura nohsi
eimat yah hat paten dasi hat patepriwa daham gure
gwemat orhe brer tit pokwi nohnong nadarhetipmur.
Got oh orhe mon nohnong ma nadarhetip oh Kakdah ihir er
hat pati ohoh ihan go susa er han ihirnong sama eimat er
teinong matinmur napor na nadarhetipmur. Go susa
ihirnong amburinmur napor nadarhetipmur.



1 Jon 5:11-13 Got orhe ma naporpat meng oh mamaru hat patmur. Got norhor norhe brer ohe dap teidapat gurnong eimat yah hat paten dasi nahat napapatmur napor dirnong am nahapatmur. Yah hat eimat paten da oh imat napin pat ohoh ihan mon orhe tapnong hat pati bap diroh yah hat eimat paten dasi hat pati bap dirmur. Mon orhe tapnong na hat pati bap ihiroh ama eimat yah hat paten dasi na hat pati bap ihirmur. Monhera. Nohe mama brak mat nasar moh Got orhe brer ohnong Ohwi ihtin han pat ma hapat ma dahapti gurnong brak mat mama nasar ohmur. Ma nasar oh gur Nuhur arpin eimat yah hat paten dasi hat pati ma hapat daham ha am hatingwe rim noh mama brak mat nasar ohmur.



Jon 14; 2 Korin 5; Erer tarpatipra 4, 21, 22

Storyline by: Edward D. Hughes

Illustrated by: Lazarus
and Alastair Paterson

Adapted by: Sarah S.

Oksapmin NT (opm) © 1992, Wycliffe Bible Translators,
Inc. All rights reserved.

<https://live.bible.is/bible/OPMTBL/MAT/1>

©2025 Bible for Children, Inc.

www.M1914.org

www.bibleforchildren.org

