

www.BibleForChildren.org



Juan 14



Sinugid gasi i Jesus, kwan ye, "Kasi' myu ipesusa' atey myu sabab et bebresan ku. Mengarap kew dut Empu', sampay mengarap kew gasi daken. Dut benwa et Empu' Ama' ku, mekansang sisingled. Ba' diki megkwantin, isugid ku dimyu."



"Na, sumurung ku dun supaya penyapan ku kemyu et menge' lelegdengan. Ba' duntin ku ne, nepenyapan ku ne kemyu et lelegdengan, peuli' ku gasi apang isien ku kemyu. Ba' embe legdengan ku, untin gasi legdengan myu."



Akung si Juan, menggandel gasi iba-iba myu
dut ki Kristo. Keiba-iba gasi kityu dut
keliyutan. Kesendalan tyu sabab

binggey et Empu' kityu
basag, sabab lang

pegmilik tyu
ki Jesus.

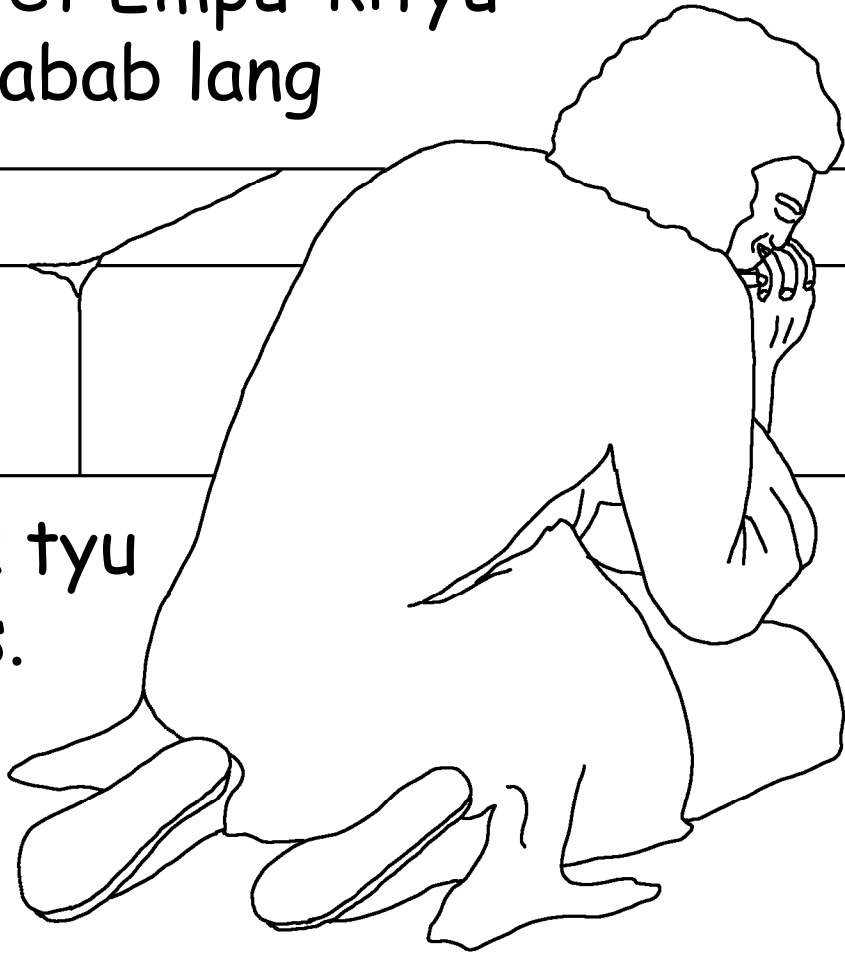

Aku pinirisu ne, tinimbang dut pulew et Patmus
sabab lang dut pegtuldu' ku et bebresen et
Empu' beke' pegpepesebanar

pasal ki Jesus.

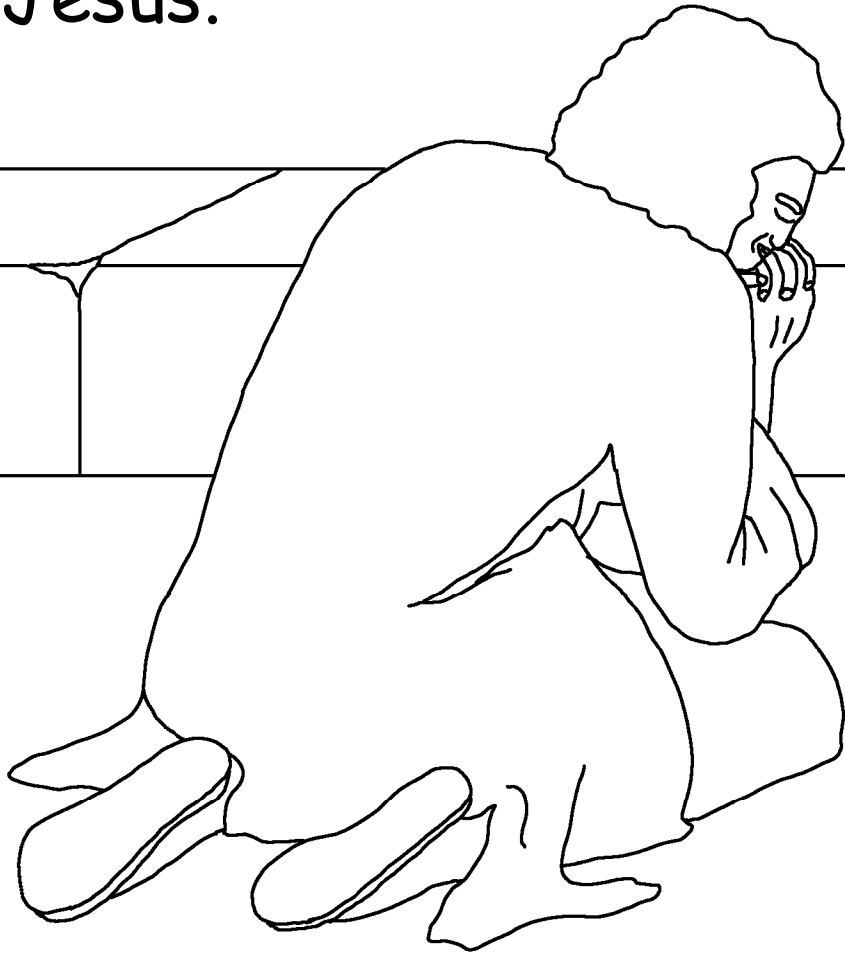

Dimpelan aku megtuy et Empung Nakem, beke' nebiri'
ku dut langit ating sembatung metaas na eerungan
beke' sembatung megearung na Empu' duntin.



Pegketbes nekingeg ku ginsan mence' pinendyari na
biyagan nemegkanta, dut timbew't dunya', dut seled
dunya', beke' dut sengkelingkepa't
dagat, sampay ginsa't seled atin,
kwan dye, "Dut kenye na
megearung dut metaas na
eerungan, beke' dut ating Ibun
et Bibili ibgey
kenye ating
kedeyewan,
kebentugan,
kereklaan,
beke'
kepengdyarian,
daran-
peraran."

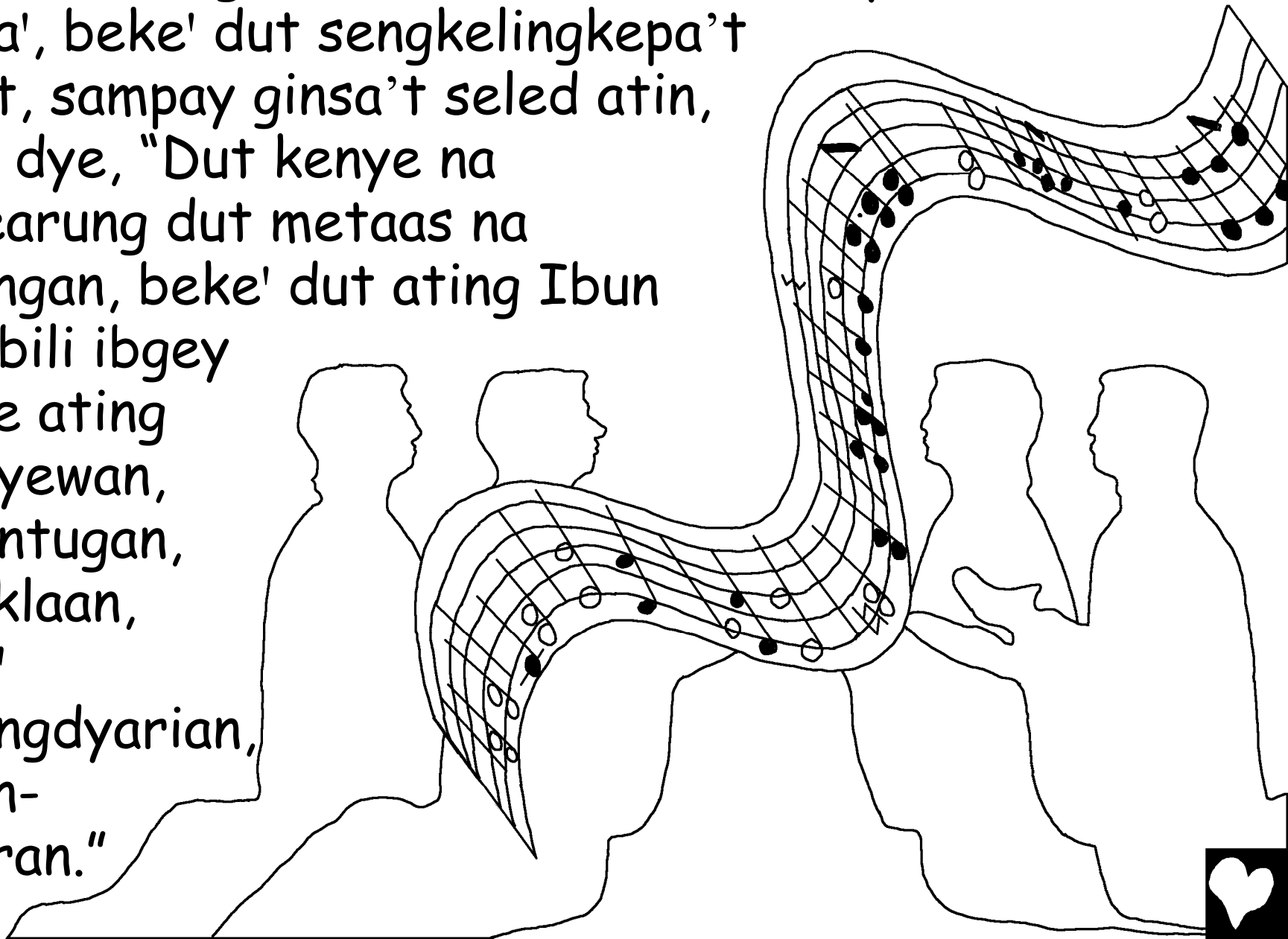

Nebiri' ku ating mebentel na lungsud, ating bagung
Jerusalem, pesesanad mawa' dut langit, tihad dut
Empu'. Antangan ye samat libun neng ibulun pinanyap
dut kenyeng mepengesawa.

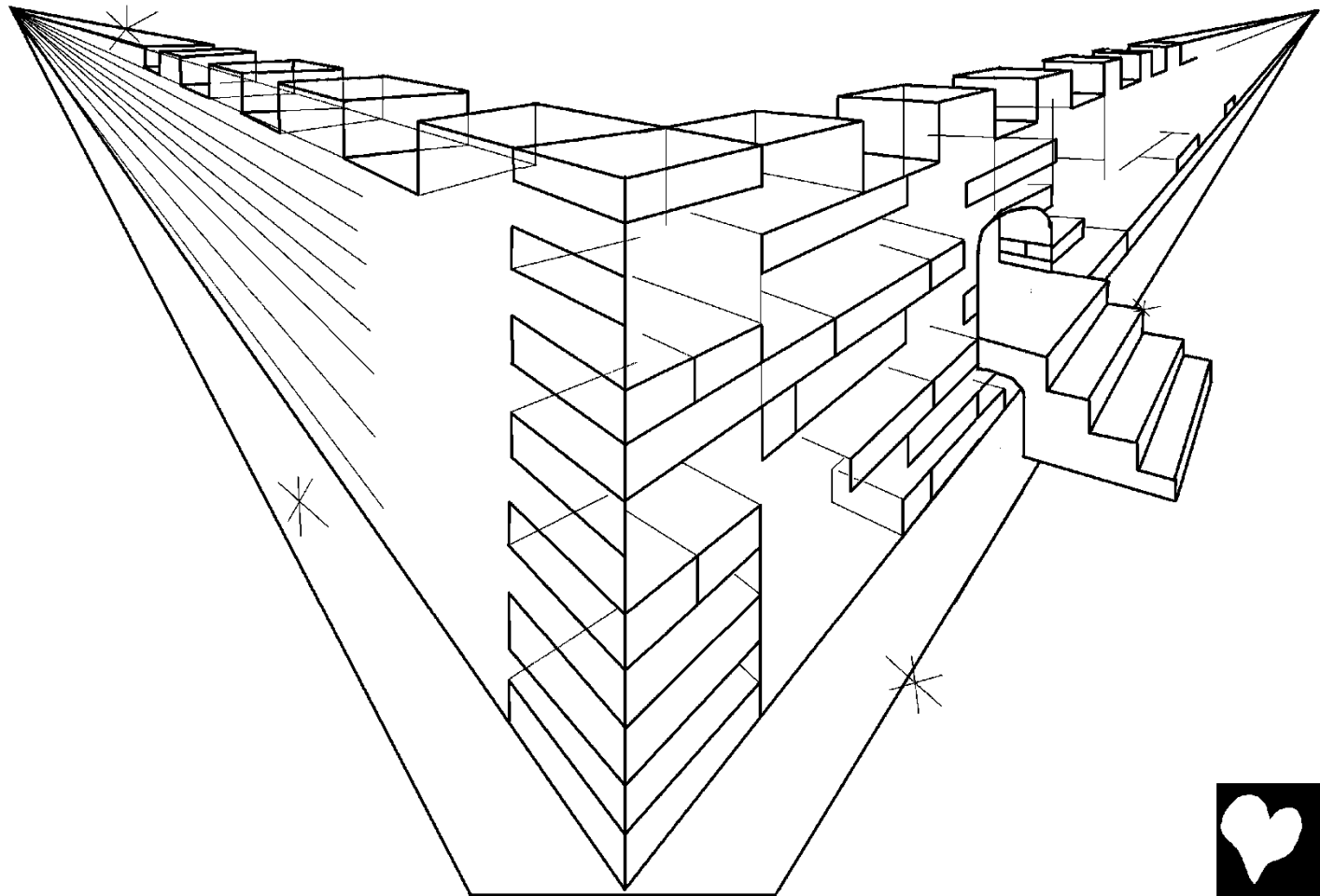

Indyari mawa' dut metaas na eerungan et Empu' nekingeg ku sembatung mebasag na beres ne negsugid, kwan ye, "Tiban ating lelegdengan et Empu' atu' ne et menge' taaw, beke' Empu' mekebaya' dye ne. Dye atin megmendyaring taaw ye. Beke' Empu' mekebaya' diri ye sampay ya atin megmendyaring Empu' dye."

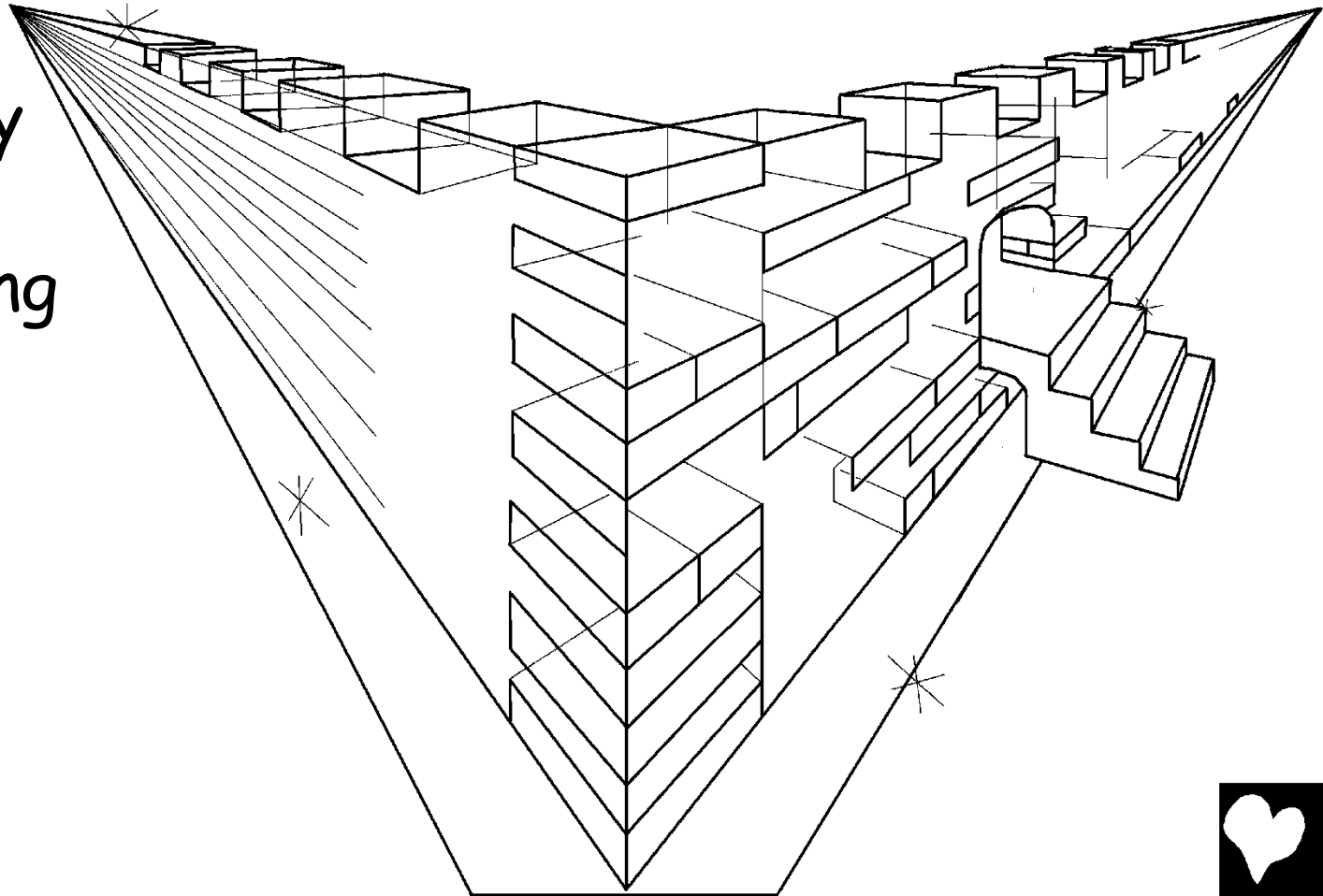

Pegketbes et itue e, ipinebiri' dut daken et dereakan
et Empu' ating danumen et danum na megkebiyag,
meligew samat sereming, megbuburbur mawa' dut
metaas na eerungan et Empu' beke' Bibili.



Diki ne keilangan eldew etawa bulan supaya meminyar eset ating lungsud, sabab ating ketaasan et Empu' atin megbebegey et telang, beke' ating Bibili atin ne silu' ye.



Kaya ne enu negang meridi' na mekesled
duntin, megdemikian sebarang
megpemuwat et kelelewan
etawa megpengembut.
Mekesled lang duntin
sebarang ingaran
neng nekesurat
dut Buuk et
Biyag na buuk
et Bibili.

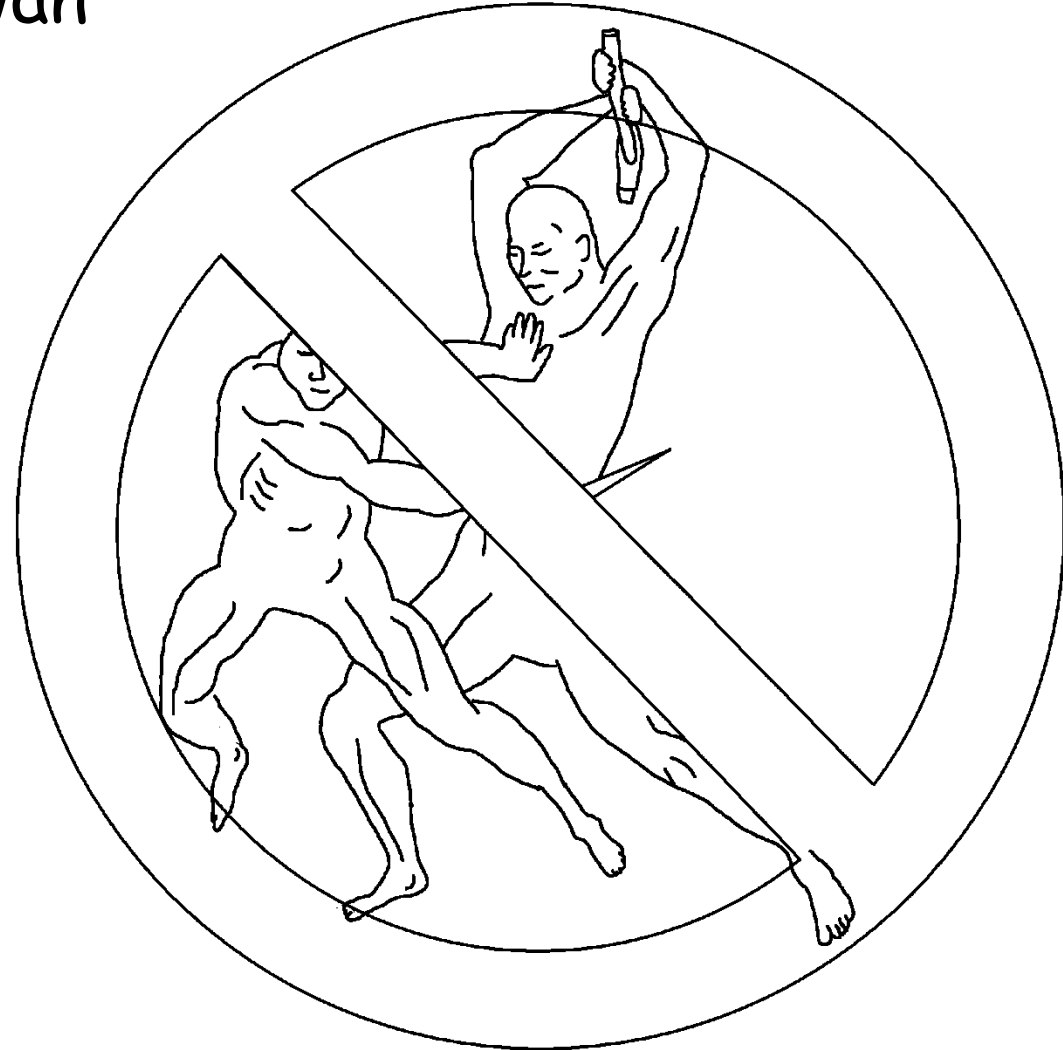

"Peyren ye ginsa't luha' dut
kedyeng mengine' mata. Kaya ne
ating kepeteyan, etawa keliyutan,
etawa pegluha', etawa irab beke'
sakit, sabab et inugad ne et Empu'
itueng mengine' ginis."



Kaya ne bisa et sukna'. Ating metaas na eerungan et
Empu' beke' Bibili mebiri' dut lungsud, beke' kenyeng
uripen memegsuku' dut kenye. Ating Empu' mebiri'
dye ne rupa ye, beke'
kenyeng ingaran
mebiri' dut
kedyeng peges.



Beke' nebiri' ne memegtitiyeg dut elepan et metaas
na eerungan et Empu' ating munge' patey, mererekla'
beke' mebebaba', beke' neukaban ye munge' buuk.

Sembatu negang buuk inukaban, itue e ating Buuk et
Biyag. Inukum ating munge' patey kuyun
dut kedyeng binwat, kuyun dut
nekesurat dut munge' buuk.

Ginsa't taaw na kaya
nekesurat ingaran
dut Buuk et munge'
Biyag Beberapa,
itimbag dut
kerkewaran neng
dagat neng apuy.

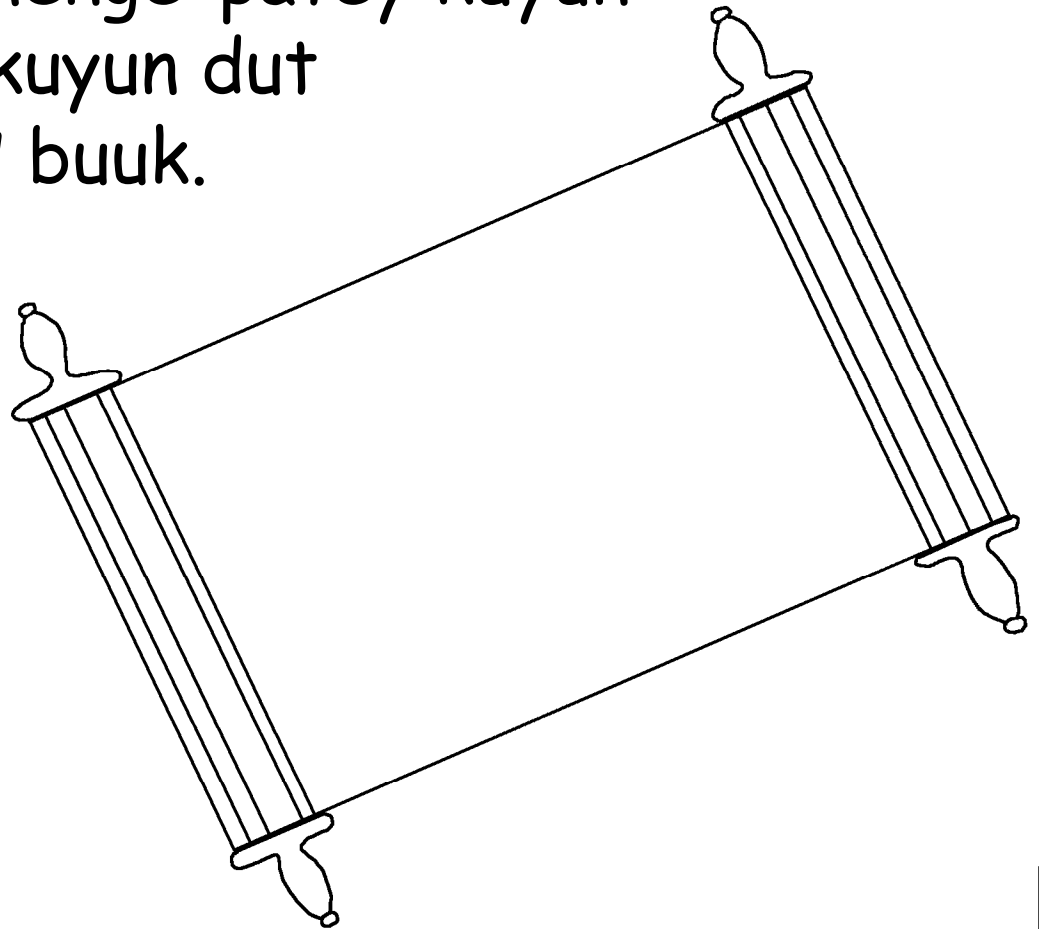

Sinugid et Empung Nakem beke' ating libun neng
ibulun in, "Ani' ke!" Ginsa't mengine' nekekingeg
megsugid gasi. Aku neng si Juan negsugid gasi,
"Ani' ke!" Sinu-sinu pegtutuknewen pekabi', beke'
sebarang meingin mengisi' et danum na megkebiyag,
isia' ne atin na kaya lang bayad.



Sabab mekasi
banar Empu' eset minge' taaw atue't
sengkedunyaan, ne binggey ye kenyeng
bugtung na Yegang supaya isimaya',
supaya sebarang mengandel kenye
diki lang metiksa' dut Narka',
segwa' maya biyag na' kaya
seskeran dut elepan
et Empu'
Banar.



60

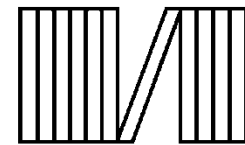

60



Roma 3:23 Sabab ginsan negkesala' beke' diki nekeapet dut ketaasan et Empu'.

Roma 6:23 Sabab kebeyaran et keselaan kepeteyan, segwa' ating bebgey et Empu' biyag ne kaya seskeran dut pekikisembatu ki Kristo Jesus na Begerar tyu.

Hebreo 9:27 Tinimpuan taaw kasa ga matey, pegketbes atin dumateng ating pegukum et Empu'.

Epeso 2:8,9 Sabab eset redyiki' et Empu', atin ne angkan nepuwas kew ganang nengandel kew ne ki Kristo. Sabab lein lang itue punsabab eset dimyung pegkeredyanen na kemyu mepuwas, temed erapun itue begey dimyu mawa' et Empu'. Kaya misan sinu megmeabbu sabab nepuwas kew itue lein lang eset dimyung keradya.



Roma 10:9,10 Ba' ipesebanar mu ne, kwan, "Si Jesus, atin Begerar ku" beke' mengandel ke dut atey mu na ya binyag et Empu' teyeg et kepeteyan, mebawi' ke. Sabab pengandel ke pebiya' dut pusu' angka pinepantun ke et metigna' dut pemiri' et Empu', beke' pepebnar ke gasi na si Jesus atin Begerar mu pebiya' dut baba' mu angka nebawi' ke

Juan 3:16,17 Sabab mekasi banar Empu' eset menge' taaw atue't sengkedunyaan, ne binggey ye kenyeng bugtung na Yegang supaya isimaya', supaya sebarang mengandel kenye diki lang metiksa' dut Narka', segwa' maya biyag na' kaya seskeran dut elepan et Empu' Banar. Sabab diki lang pinelusu et Empu' kenyeng yegang supaya ukuman apang dusaen menge' taaw atue't sengkedunyaan, imbes supaya puwasen ye menge' taaw mawa't keselaan dye.



1 Juan 5:11-13

Indyari itue ne pesebanar: Dinuul ne kityu et Empu' biyag na kaya seskeran beke' biyag ne itue meterima tyu lang pebiya' eset Yegang Ye. Sebarang pegtetegan et Yegang et Empu' in, maya biyag na kaya seskeran. Segwa' sebarang diki pegtetegan et Yegang et Empu' in, kaya biyag eset kenye. Pegsuraten ku itue dimyu apang mesewran myu na kemyung mengengandel dut Yegang et Empu' in maya biyag na kaya seskeran.



Juan 14; 2 Korinto 5; Pebunayag 4, 21, 22

Storyline by: Edward D. Hughes

Illustrated by: Lazarus
and Alastair Paterson

Adapted by: Sarah S.

Palawano, Brooke's Point NT (plw) © 2018,
Wycliffe Bible Translators, Inc. All rights reserved.

<https://live.bible.is/bible/PLWWBT/MAT/1>

©2026 Bible for Children, Inc.

www.M1914.org

www.bibleforchildren.org

