

Biblia ya Ugugaw  
presents

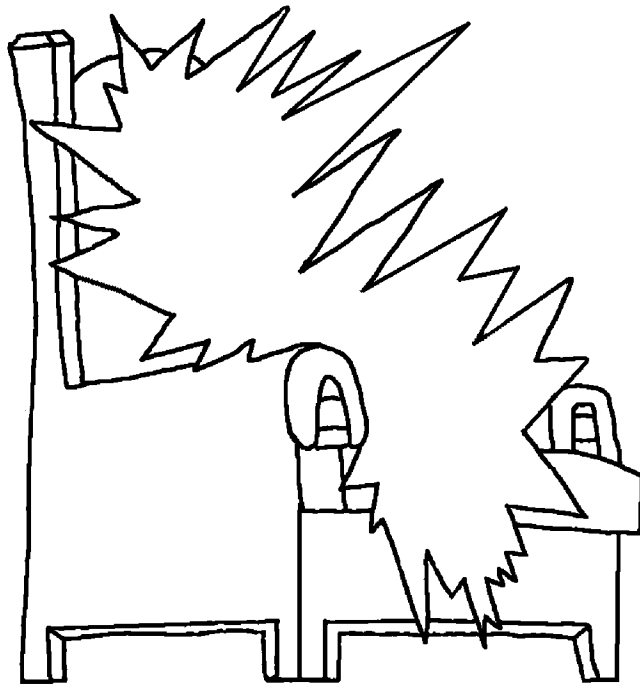

Say Tawen,  
Balibalin  
Abung a  
Katawan



Insulat nen: Edward Hughes

Inyilustra nen: Lazarus  
Alastair Paterson

Inadapta nen: Sarah S.

Inpatalos nen: [www.christian-translation.com](http://www.christian-translation.com)

Pinawala nen: Bible for Children  
[www.M1914.org](http://www.M1914.org)

©2021 Bible for Children, Inc.

Permiso: Wala'y kanepagan mon kopyaen o iimprinta yan istorya,  
pwera labat ya ilako.



Nen nanbilay si Hesus ed dalin, inistorya tod  
disipulo to tungkol ed tawen. Tinawag to man na  
"Abung nen Amak", insan dakel so mansion diman.  
Baleg tan marakdakep na  
abung so mansion.



Inkuan nen Hesus, "Onla ak a mangiparaan na sakey a pasen parad sikayo, ompawil ak tan awiten ta kayod ayaman ko." Linma ed tawen si Hesus, kasumpal ton binmilay lapud patey. Legan a sankanengneng da, nipaatagey si Hesus, tan sikatoy inawat na sakey a lurem.

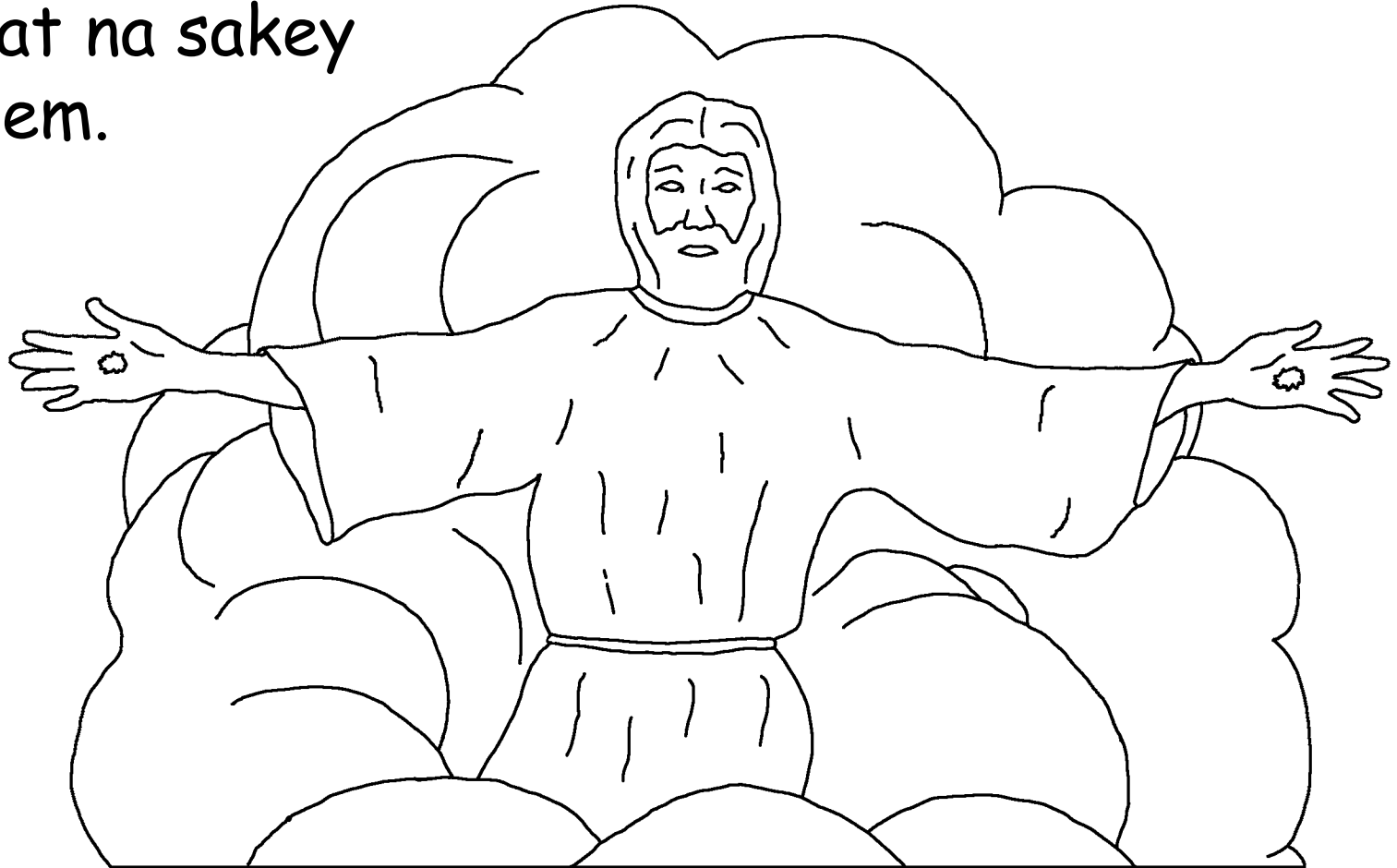

Manlapud saman, nanonotan na Kristyano ira'y insipan nen Hesus na ompawil tan awiten to ira. Insipan nen Hesus na ompawil ed panaon na aga ilaloan. Pero panunto ira may Kristyano'n inaatey antis a unsabi si Kristo? Imbaga'y Biblia a unla ira ed Hesus. Nu anggapo tayo la ed laman insan wala tayo lad Katawan.

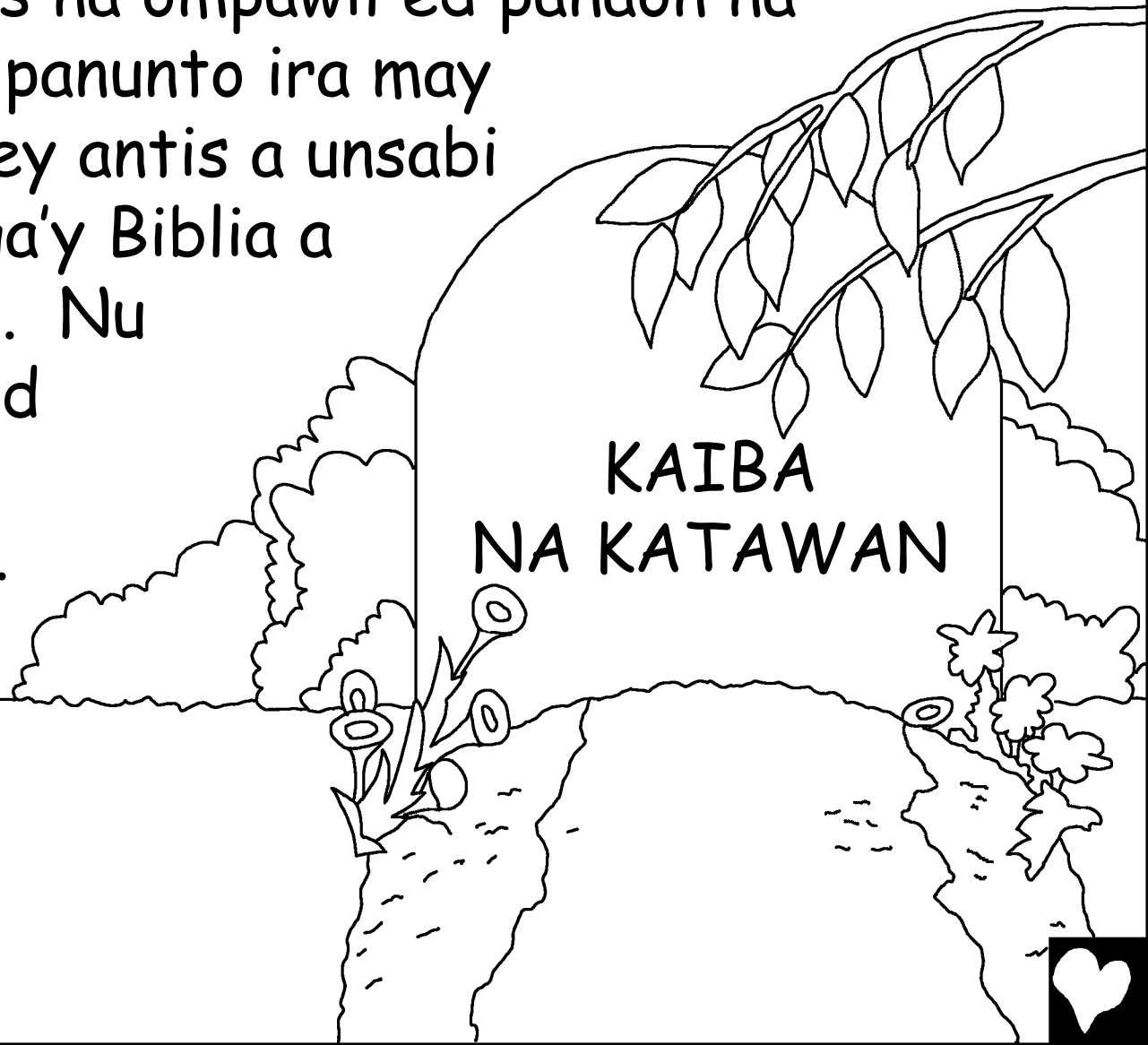

Apocalipsis, say sampot na libro ed Biblia, ibabaga to no panonton karakep so tawen. Say sangkarakepan na katuwaan, et say Tawen so Panaayaman a Katawan. Walad amin a pasen so Katawan, balet walad tawen so trono To.

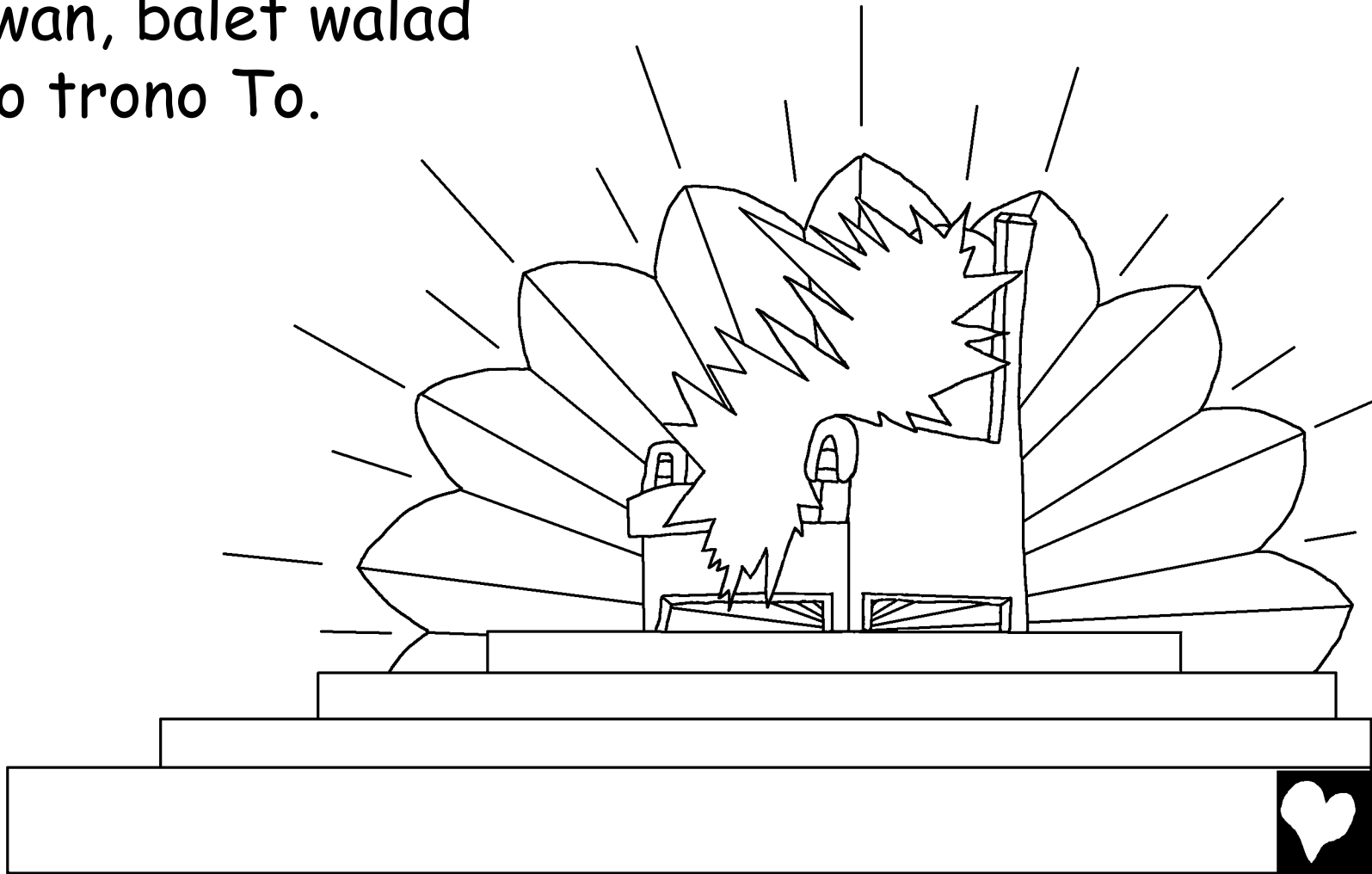

Unsasambad Katawan so amin  
a pinalsad tawen tan ara'y  
anghel, pati ira'y totoon  
inaatey na wala lad tawen.  
Mankakansion ira na parad  
Katawan.

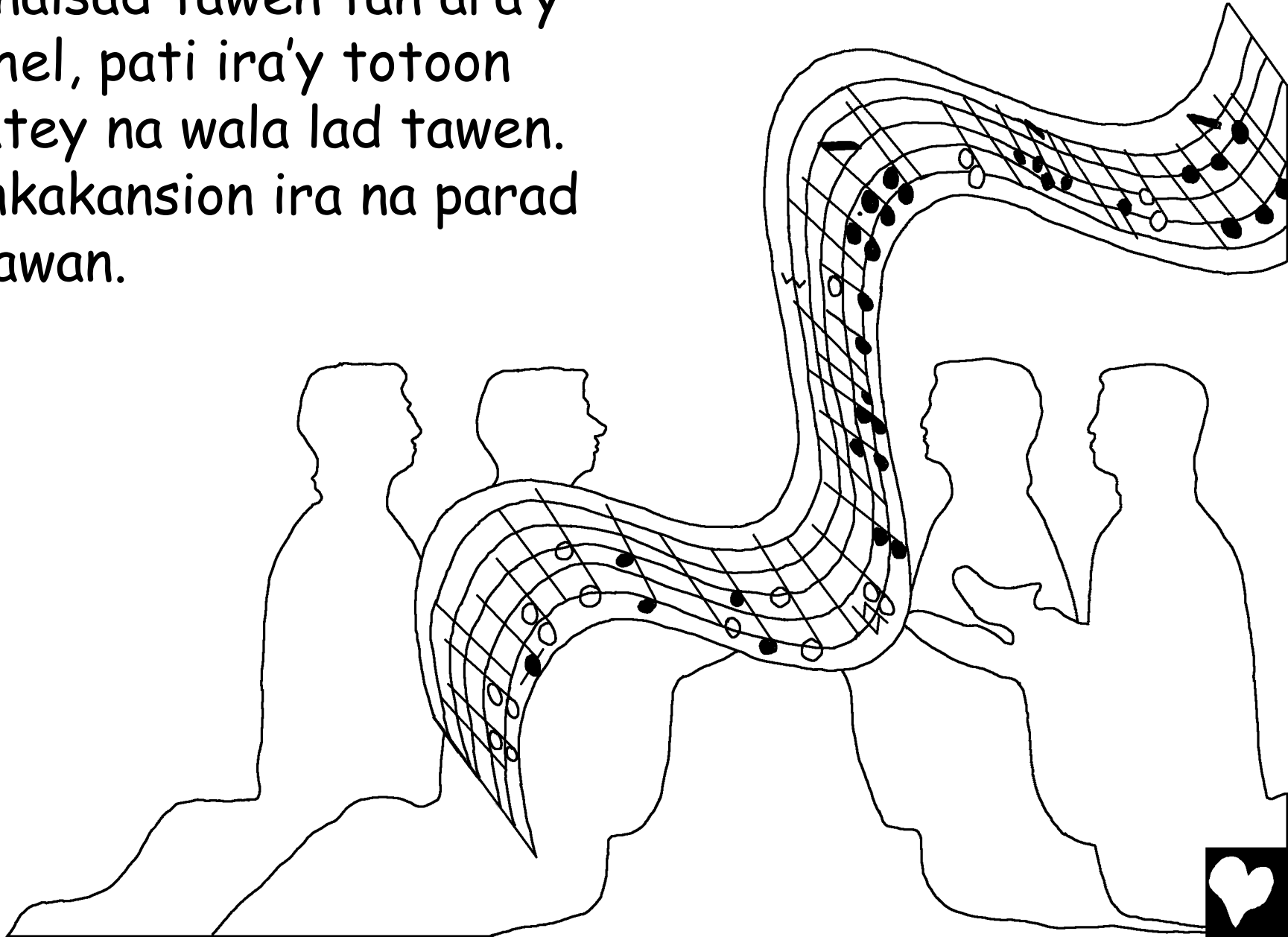

Niraya so pigaran salita na kansyon da: SIKA SO  
MAKANEPEGAN TA SIKA SO NANDONDON ED  
SIKAMI LAPU ED DALAM, ED  
SARA'Y TOTOO TAN NACION  
TAN GINAWA MO KAMI  
A MANARI TAN  
SACERDOTE  
ED DIOS.  
(Apo. 5:9)

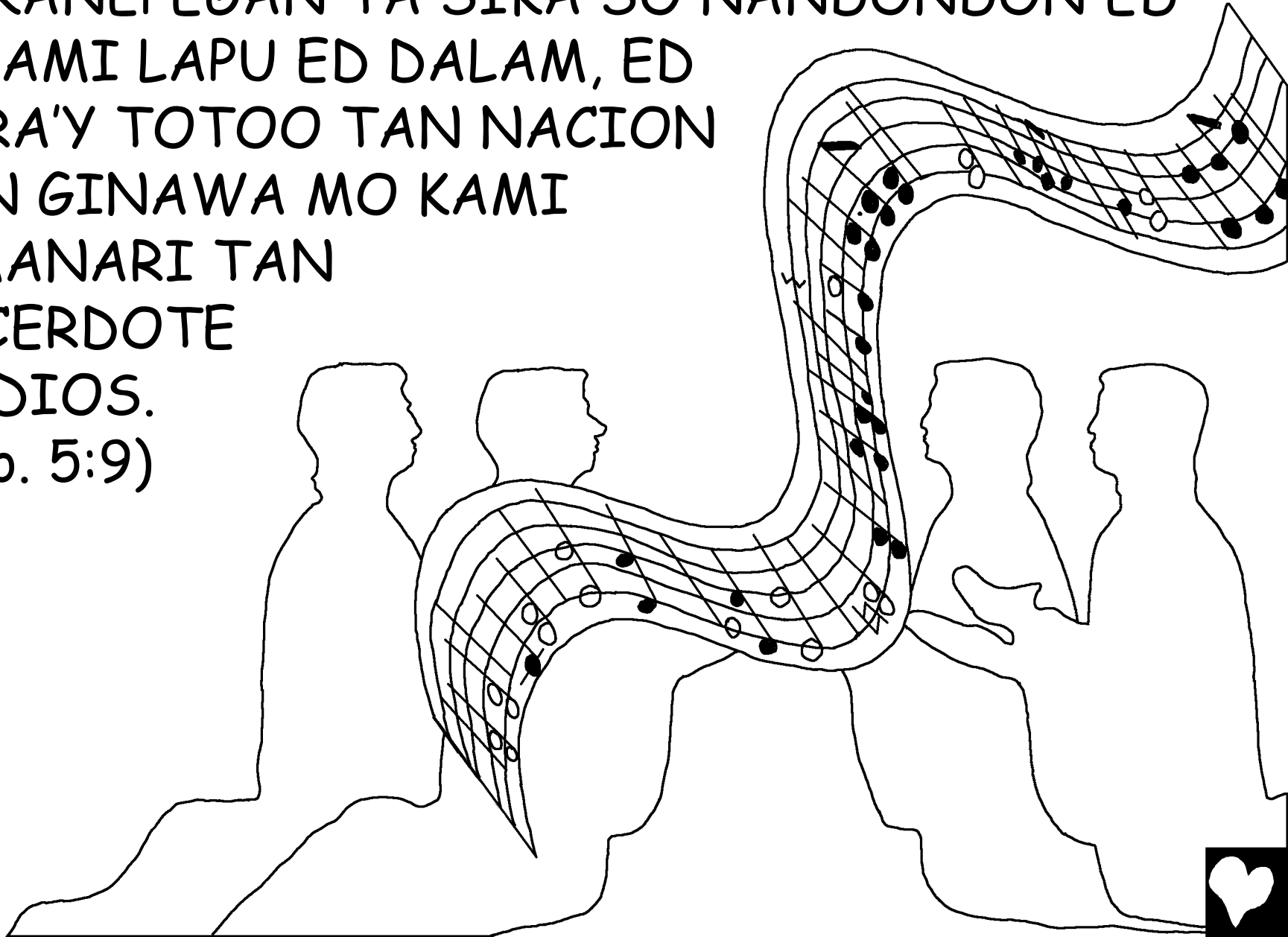

Ibabaga na sanká sampotan a pahina na Biblia so tawen ya "Say Balon Jerusalem". Talagan balbaleg tan ataragey so padir to. Bato na jaspe so padir, mankirlap a singa kristal. Ankablin bato so akatabon ed pundasyon a padir, marakdakep tan mankirlap.

Gawa ed angkabaleg na perlas so kada puerta na syudad!

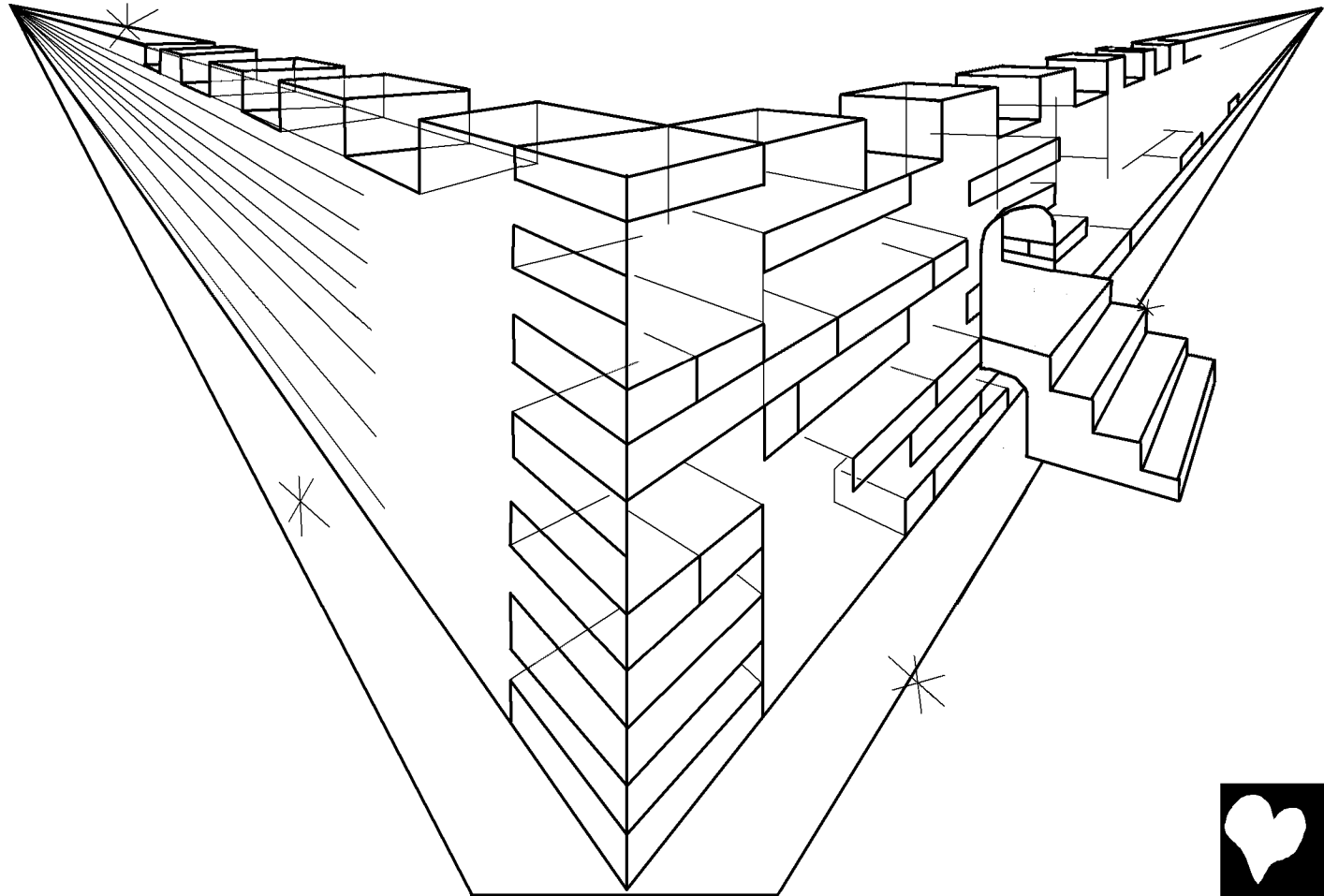

Akalukas labat ira'y angkabaleg na Puerta na gawa ed perlas. Unloob tayo tan nengnengen tayo ...  
WOW! Mas lalon marakep so loob na tawen. Say syudad et puron balitok, singa malinew a salming.  
Gawad balitok so karsada.

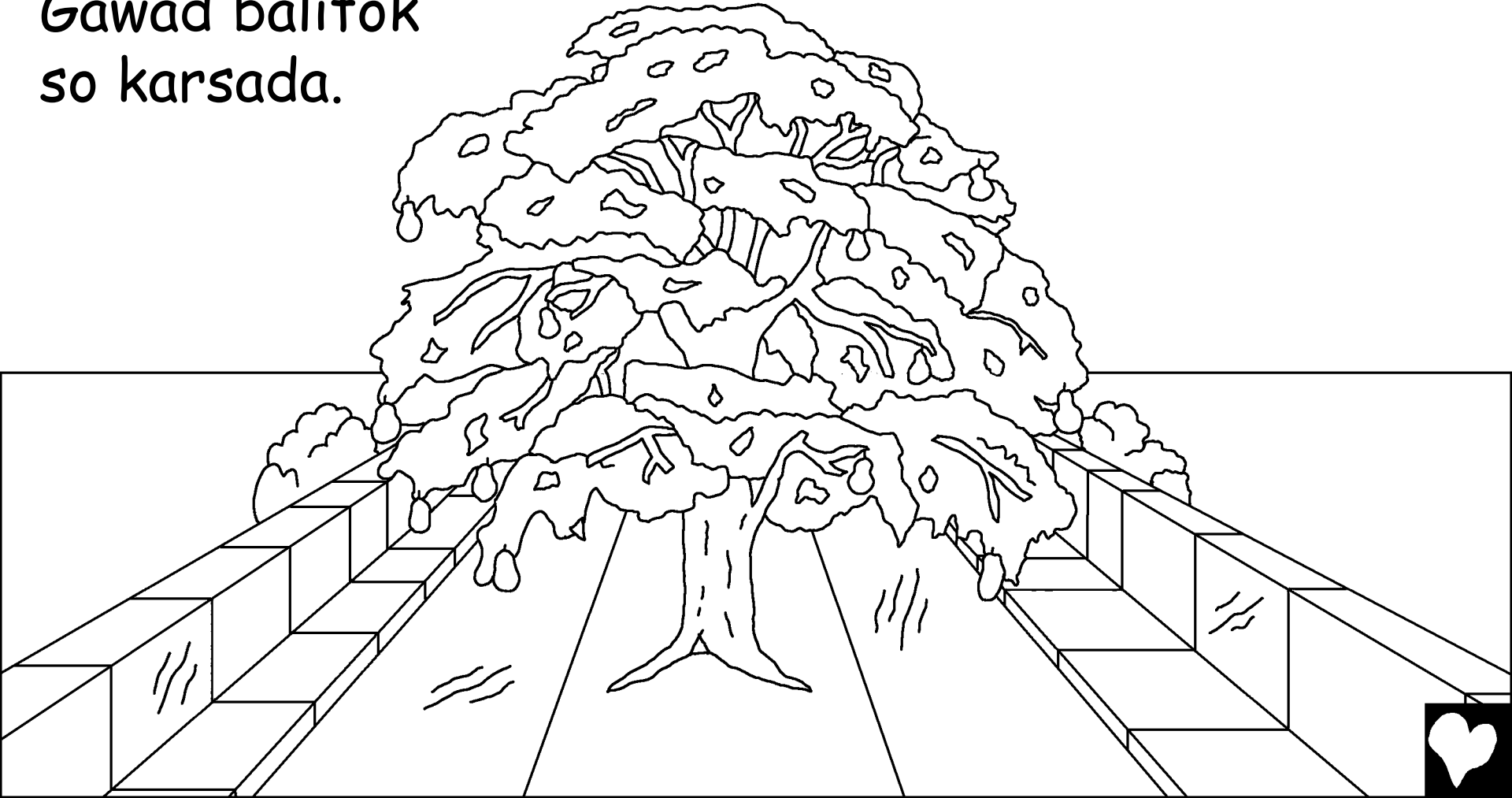

Marakdakep tan malinew na ilog a danum na bilay so unaagos manlapud trono na Dios. Walad basil a pasen na ilog may kiew na bilay, ya unaan na anengneng dyad Hardin na Eden. Espisyal ya maong yan kiew na bilay. Manbubunga na labinduan nanduruman klase kada bulan. Parad pamaabig na amin a nacion so bolobolong na kiew na bilay.

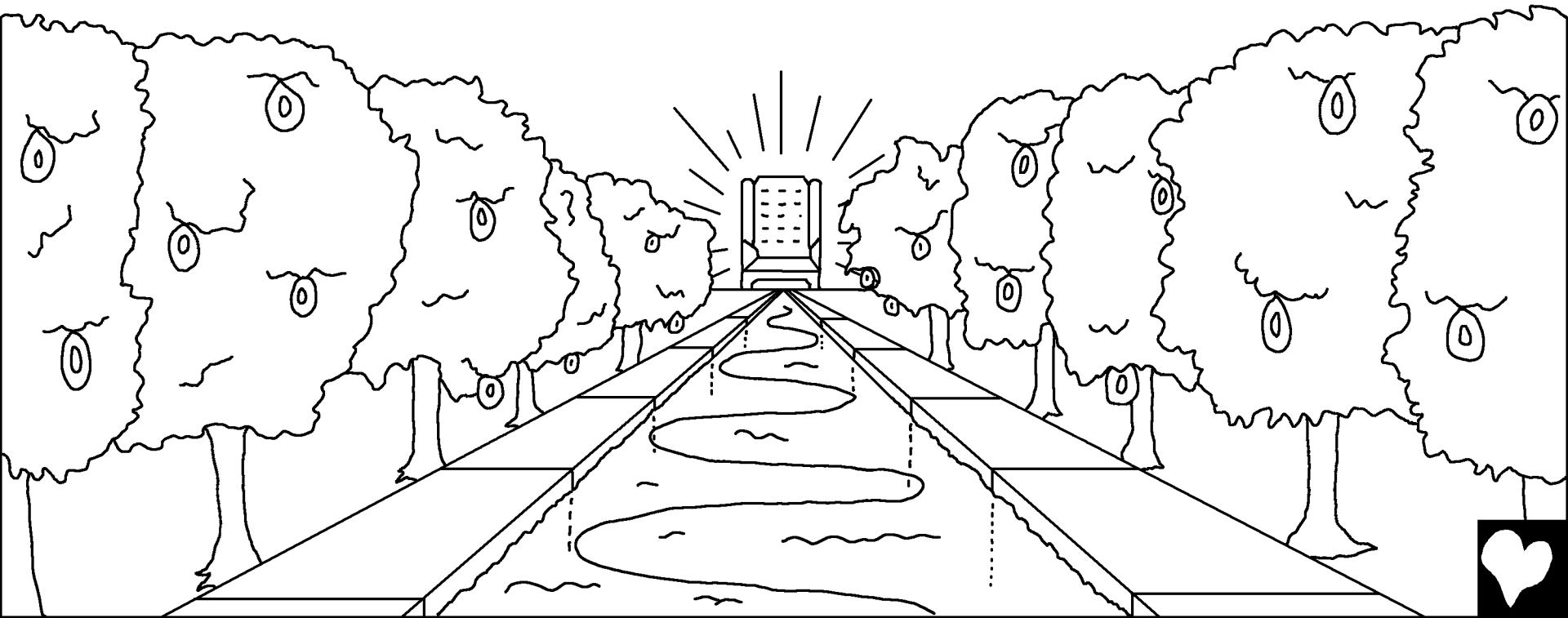

Agkaukolan na tawen so liwawa'y agew tan bulan. Say gloria na Katawan so mansisilbin liwawa. Anggapo'n balot so labi diman.

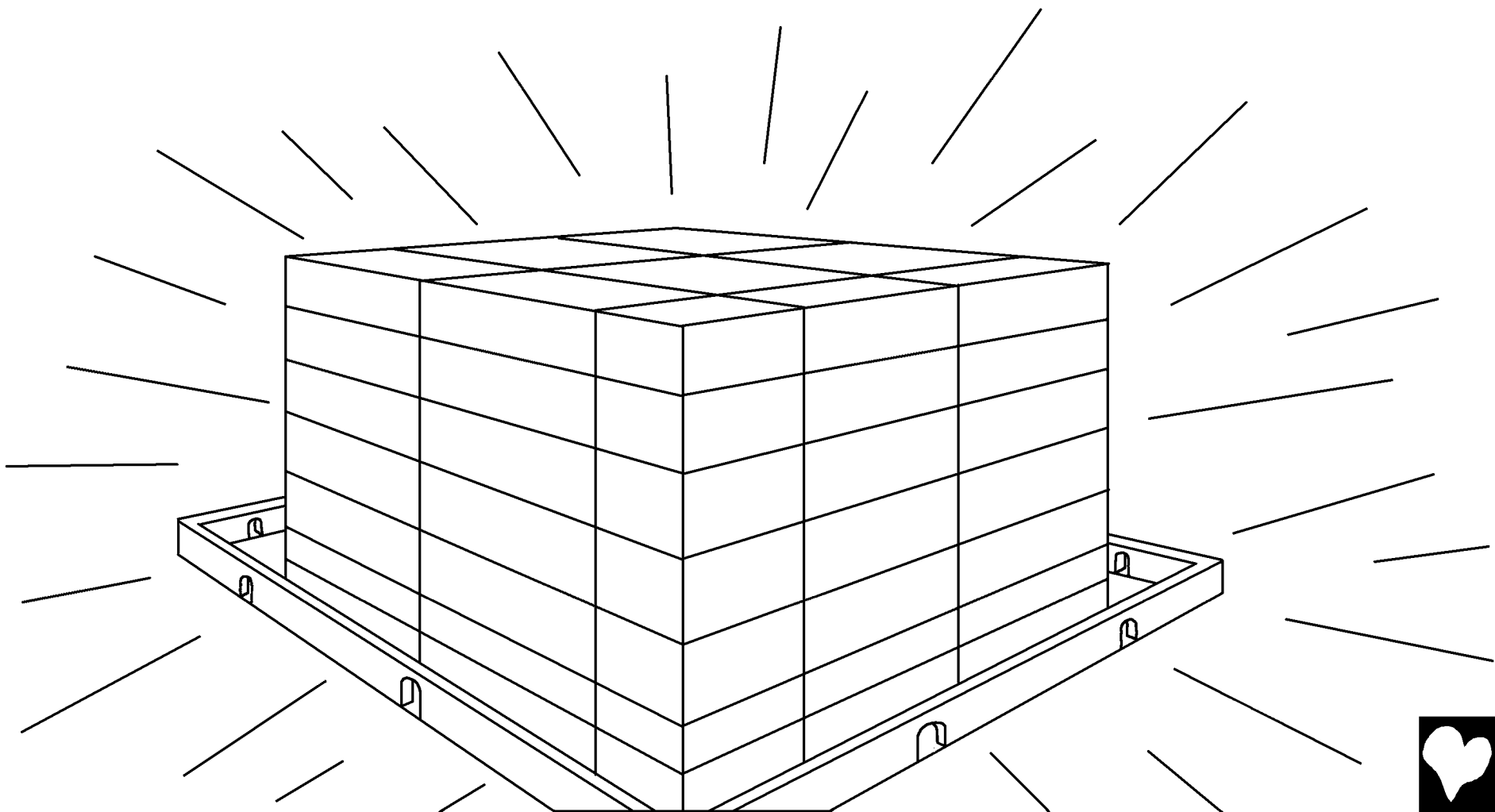

Nidumaruma anggano ira'y ayayep diman. Maaamo ira. Walad sakey a pasen so lobo tan kordero. Mamangan ira'y mabiskeg a leon na dayami a singa baka. Inkuan na Katawan, "Ag ira mankabil o manderad dyad sara'y masanton palandey Ko."



Legan na nenengnengen mi kaliberliber, naimano mi ya wala'y kulang ed tawen.

Anggapoy maniingalan.

Anggapoy mankokolkol o

makasarili. Anggapoy

kapot da ira'y pwerta

ta anggapo'y matakew

ed Tawen. Anggapo'y

matila, managpatey,

mangkukulam, o

mauges na totoo.

Anggapo'y anggano

anton kasalanan ed Tawen.



Anggapo'y lua dyad  
Tawen na kaiba'y Dios.  
Nu arom, unaakis ira'y  
totoo na Dios lapud  
baleg ya ermen dyad  
sayan bilay. Dyad  
Tawen, punasan na  
Dios so amin a lua.



Anggapo'y ipapatey ed Tawen met. Nakaiba'y totoo  
so Katawan anggad angga. Anggapo la'y ermen,  
anggapo la'y unakis, anggapo la'y pasakit. Anggapo'y  
sakit, anggapo'y hiwalayan, anggapo'y umpatey.

Malikliket so amin  
a tood Tawen na  
kaiba da'y Dios  
anggad angga.



Sankarakepan ed amin, parad sara'y ugugaw na lalaki tan bibii so Tawen (pati ira'y matakken met) ya mananisya ed si Hesu Kristo bilang Manangilaban tan ara'y inmuor ed Katawan. Walay sakey a libro dyad Tawen na tatawagen dan Libro na Bilay a Kordero. Natno'y ngaran na totoo.

Antam nu sioparan ngaran so nisulat diman?

Amin a totoo a nanlingkor ed Hesus.

Wadman so ngaran mo?



Marakep na imbitasyon so sampot na salita ed Biblia tungkol ed Tawen. "Inkuan na Espiritu tan say kasintahan, 'Gala!' Say makangel kuan to kumon, 'Gala!' Tan say napapaet, ondago. Say malabay, mangala ed danum na bilay ya anggapo'y bayar."



Say Tawen, Balibalin Abung a Katawan

Istorya a nanlapud Salita'y Katawan, say Biblia  
ya naromog ed

Juan 14; 2 Corinto 5;  
Pahayag 4, 21, 22

"Say puerta na Salita's Katawan na mangiiter  
na liwawa." Salmo 119:130



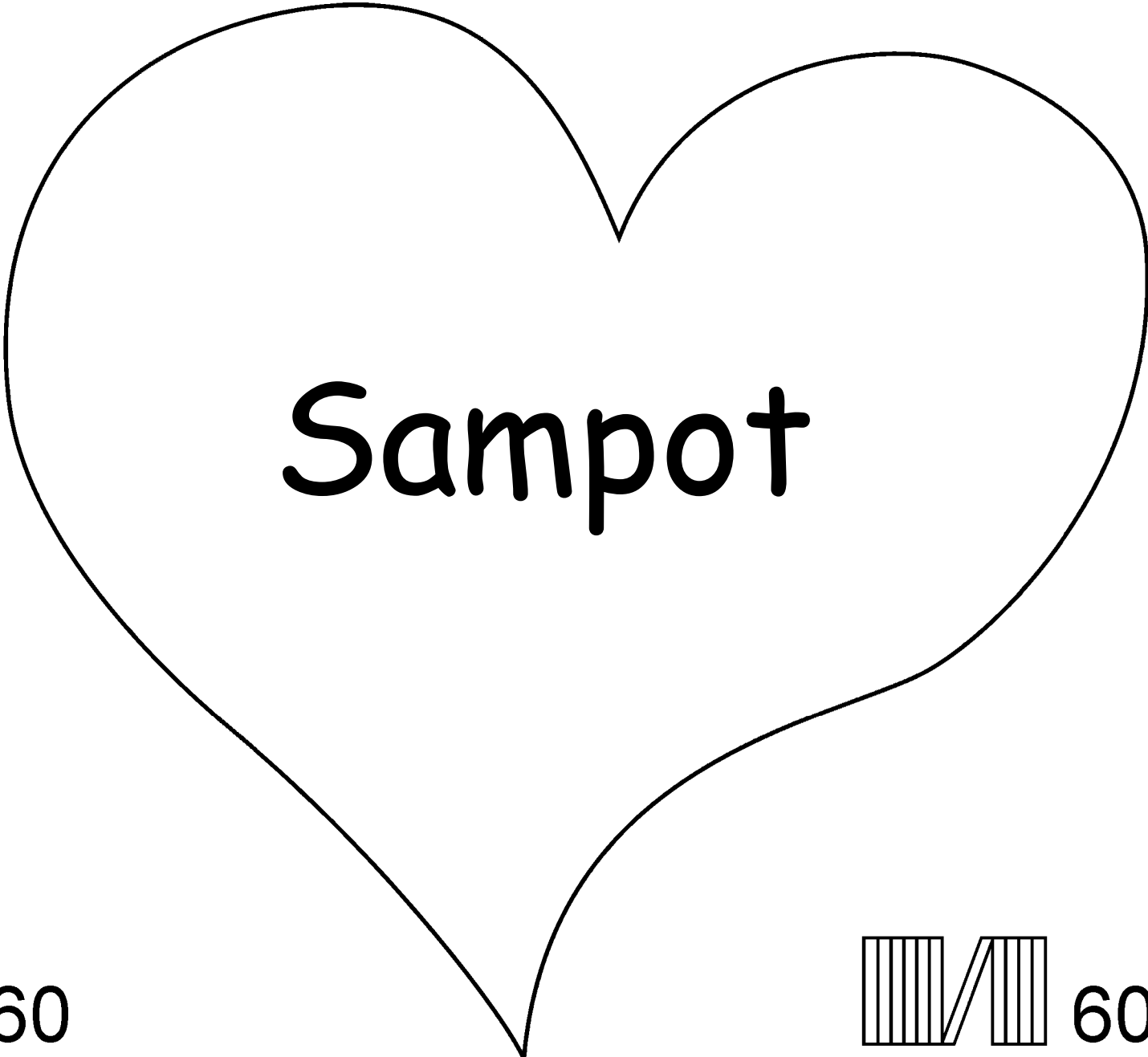

Sampot

| 60

||||| 60



Isasalaysay na Biblia so kaabigan na Katawan  
na nanggawad sikatayo insan gabay To na nakabat tayo.

Anta na Dios ya makakagawa tayo'y mauges, na tatawagen  
ton kasalanan. Say dusa na kasalanan et patey, balet inaro  
kan maong na Katawan imbaki toy bugtong na Anak to, si  
Hesus, na inatey ed krus, inako toy parusa parad kasalanan  
mo. Insan immulin bimmilay, pimmawil ed tawen! Nu manisya  
kad Hesus insan mikerew ka'y pirdona, pirdonaen To  
ka! Unloob insan manayam ed bilay mo natan, insan  
manbilay ka kaiba To anggad angga.

Nu mananisya ka na aya so katuwaan, ibagam ya ed Katawan:  
Maabig na Hesus, manisya ak na Sika so Dios, na nanmaliw  
na too pano bayaran so kasalanan mi, insan immuli Kan  
bimmilay. Bagom so bilay ko insan perdonam ak ed  
saray kasalanan ko, pano nabago so bilay ko, insan  
unsabi agew nakaiba ta Ka anggad angga.

Manbasa ka'y Biblia insan mitungtong kad Katawan agew-agew!

