

[www.BibleForChildren.org](http://www.BibleForChildren.org)



San Juan 14



Huasha Jesus cuintangahua callarira casna nisha,  
Ama manzharisha turbaringuichichu. Diosta yuyarisha  
quirichi, chasnallata ñucatahuas yuyarisha quirichi.  
Náuca Yayahua huasibiga ashca lugarguna tiyanmi  
causangahuaca, mana chasna acpiga mana cangunata  
rimaimachu arani, shuc  
lugartami  
cangunaraicu  
puruntungahua  
riuni  
nisha.



Ñáuca risha chi lugarta cangunaraicu  
puruntushcahuasha, cutillata shamungarauni  
cangunata ñucahuan pushangahua, ñuca aungaraushca  
lugarllaita cangunahuas aungahua.

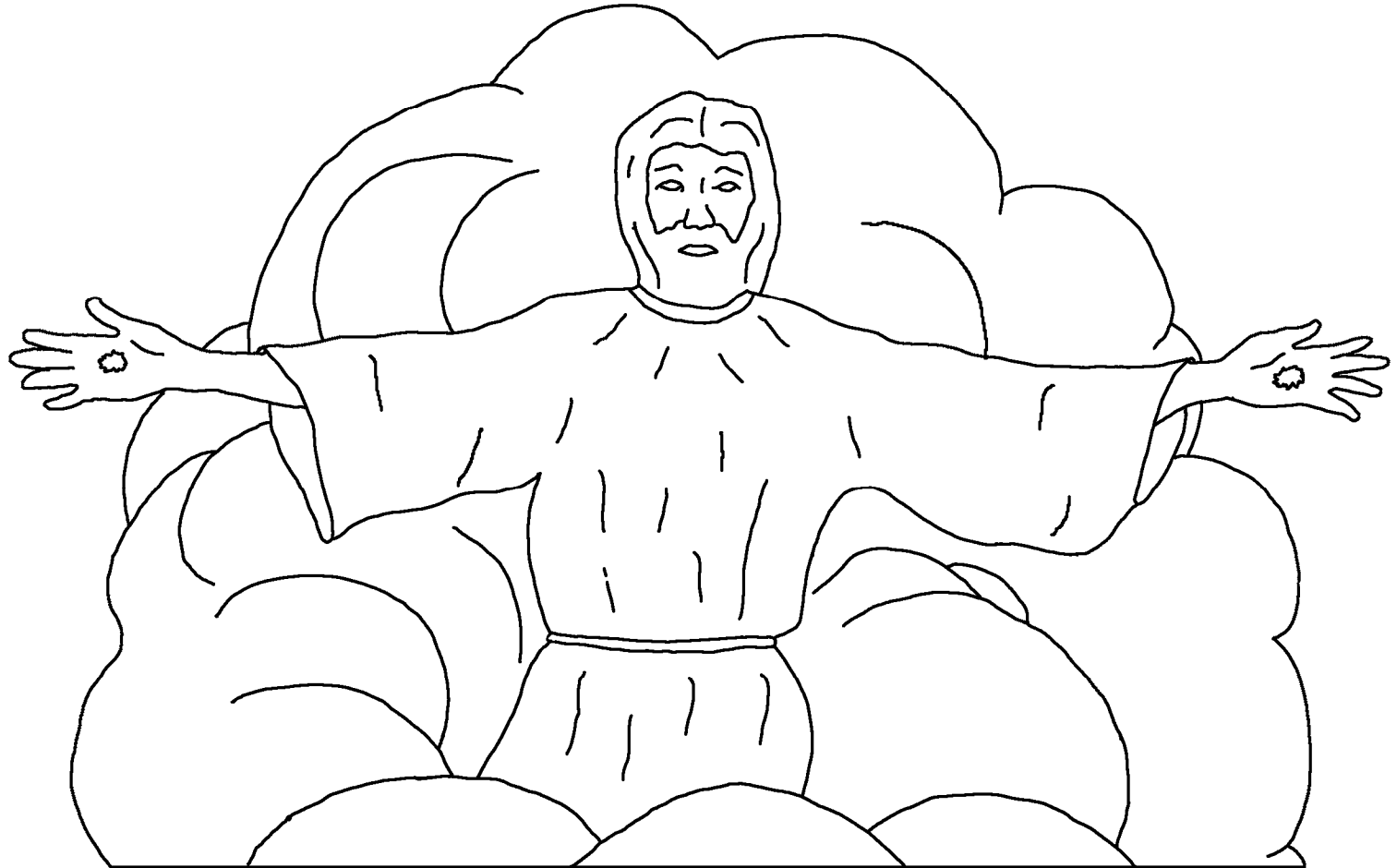

Ñáuca cangunashina quiric huauqui Juanmi ani.  
Jesucristomandami ñucahuas cangunahuan  
pariu Diospa ali mandanai auc runaguna

maunchi, cangunashinallata paimanda  
turmintariuni. Jesucristo

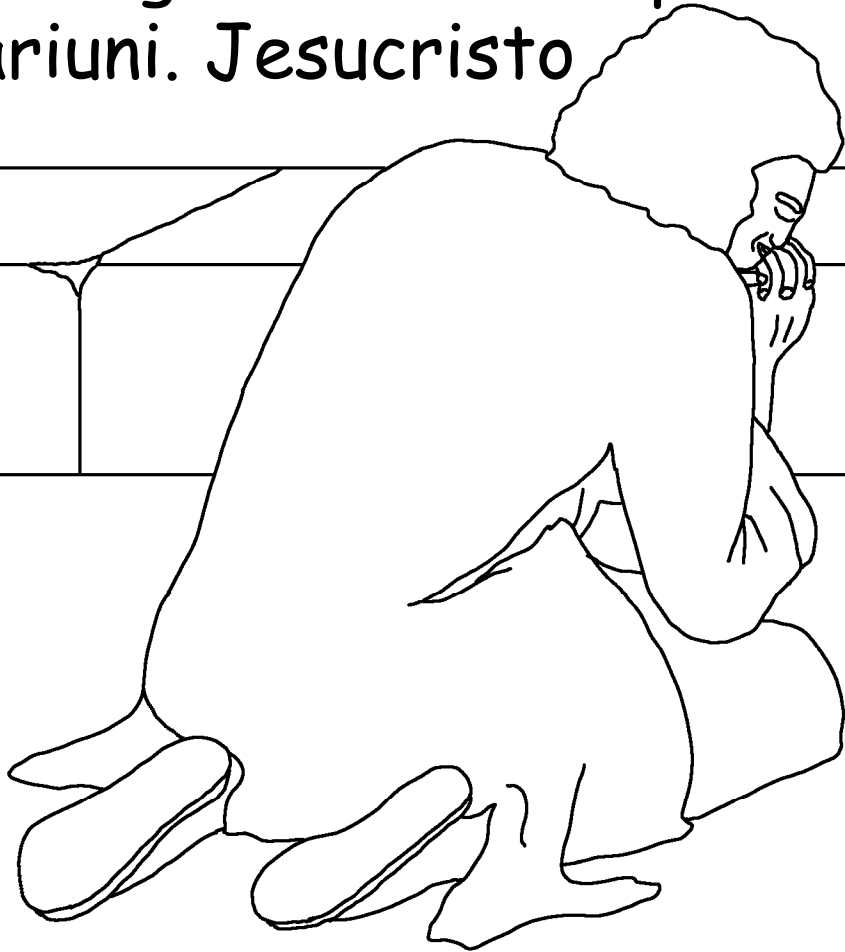

cushca ahuantana  
yuyaihan  
cangunashinallata  
pai shamunata  
chapaunimi.



Diospa shimita camachishcaraicumanda  
chasnallata Jesucristomanda  
yachachishcaraicumandahuas Patmos

nishca islaibi preso  
shitashca tiyaurani.

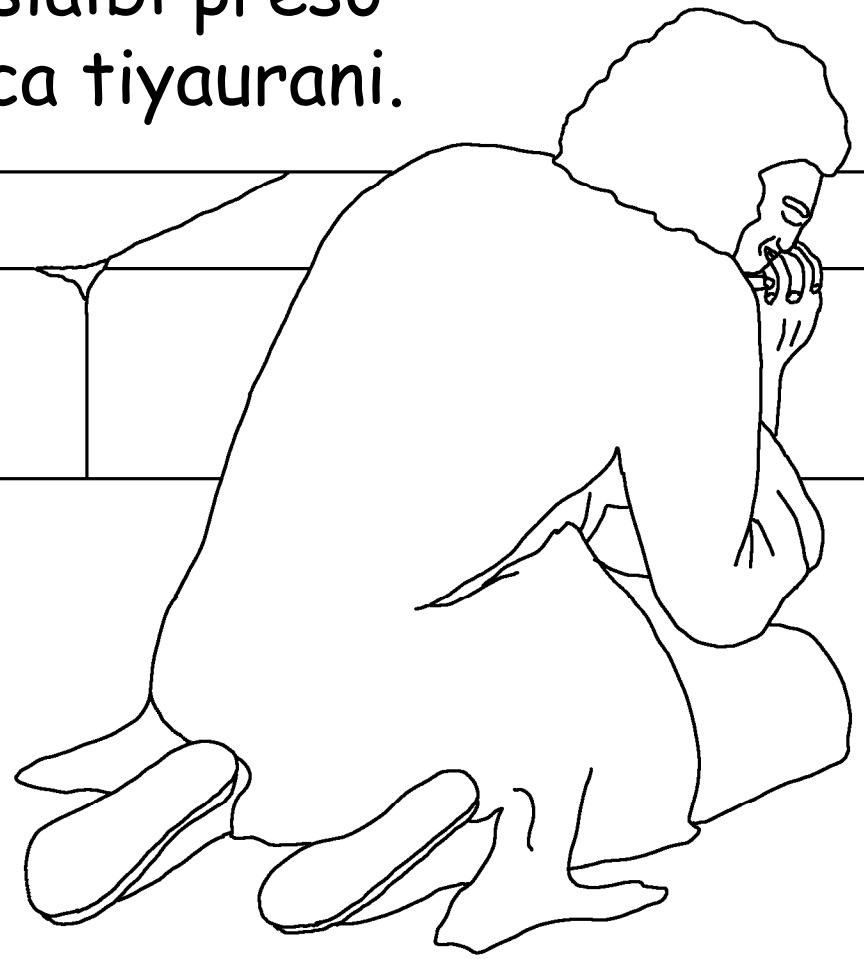

Chiratullai pariulla Diospa Samai ñucata japisha  
jahuapachama pushahuara. Chi ratullai jahuapachaibi  
shuc mandac apuhua tiyarinata ricurani. Chibi shugmi  
tiyaura.



Chasnallata jahuapachais cai pachais, allpa ucuis lamar  
ucuis tucui chigunai tiyaucunahuas Diosta alabanaura.

Tucuiguna casna rimaushcata  
uyarani: Jatun tiyarinaibi tiyauc  
Dios, Ovejahuas huiñaigama balic  
mangui nisha jahuayachisha  
alabashca tucunguimi, tucui

ushaita  
huiñaigama  
charingui  
tucuigunatas  
mandangahua  
Nishami  
rimanaura.

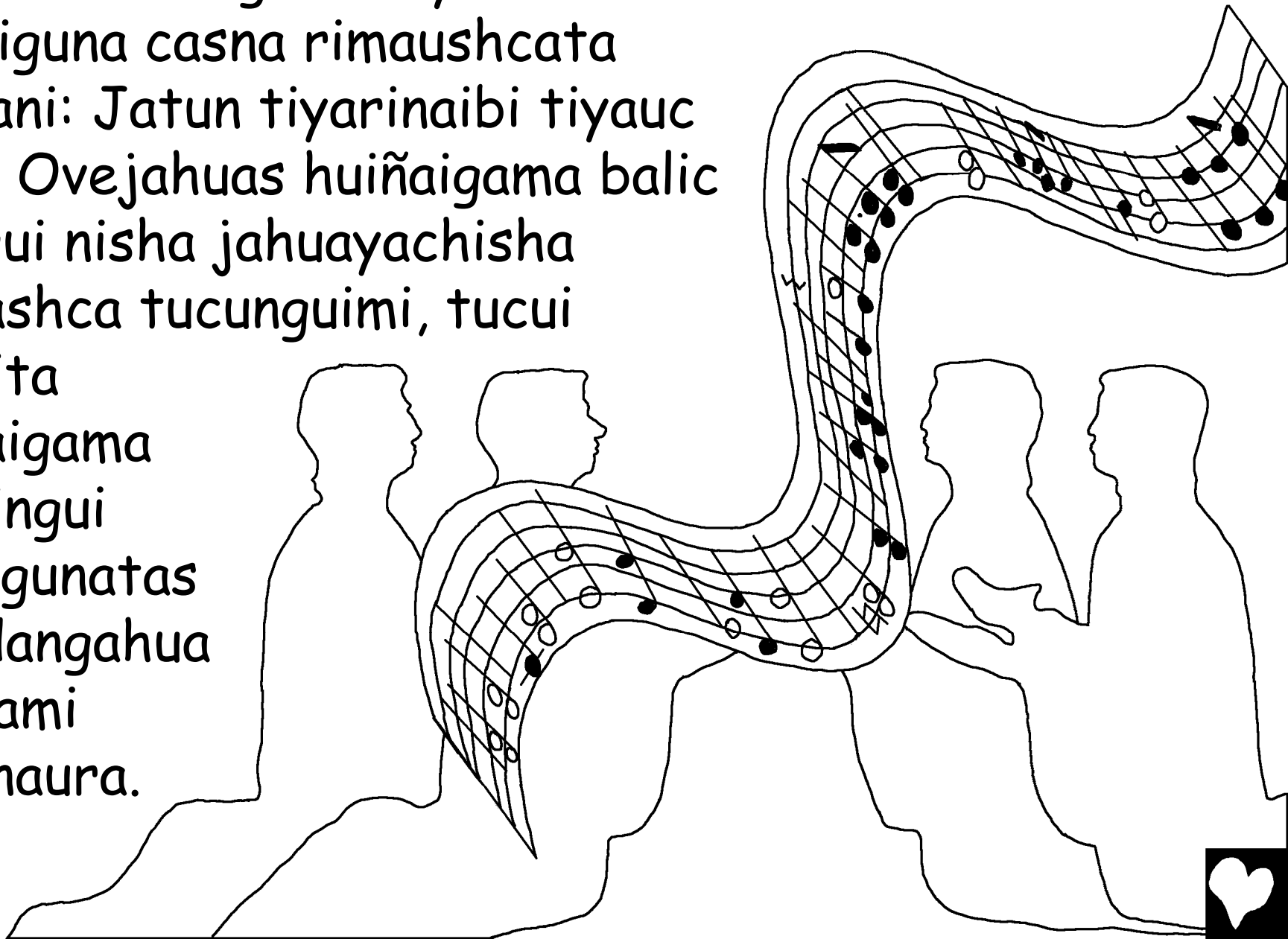

Ñáucami ricurani chi sumac llactata, chi mushuc  
Jerusalen nishcata Diospagmandapacha  
uraicumuushcata ricurani. Chiga cadsarana huarmi  
paihua carita tupangahua alichirishcacuinta sumac  
ricuric mara.

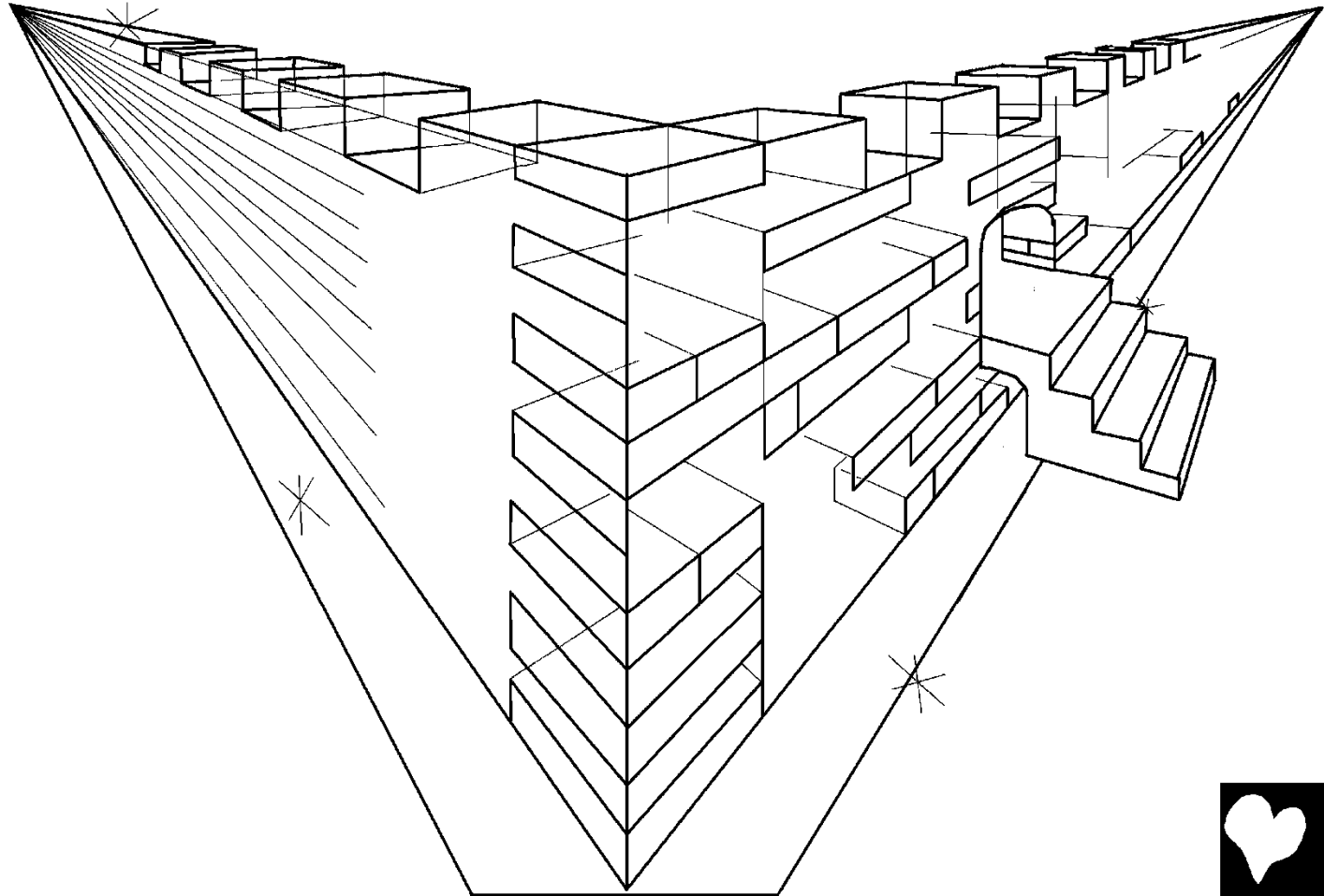

Chasnallata jahuapachamanda sinzhita caparishcata  
uyarani casna nisha: Cunanga Diospa causanaga  
runagunandi anga. Paigunahuan causangami, paigunas  
paihua quiquin runaguna manaunga. Jatun Diosca,  
paiguna Dios asha paigunahuan pariu causangami.

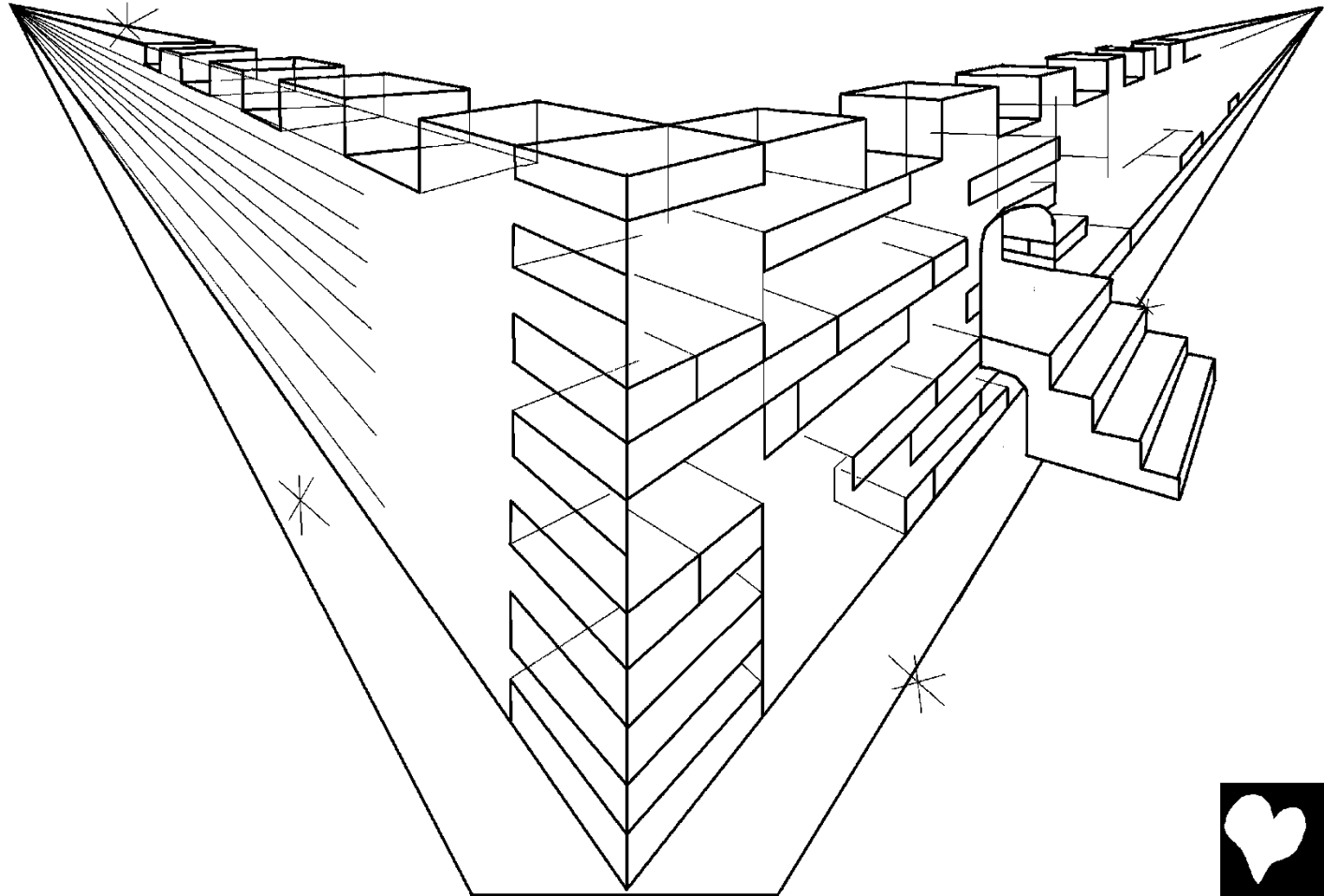

Chihuashaga chi angel shuc Causachina Yacu nishcata  
ricuchihuara, yapa pása pása ricuric chuyac yacuta.  
Chi yacuga Dios mandausha tiyarinamandas Oveja  
mandausha tiyarinamandas Ilucshiura.



Chi llactaibi Diospa sumacca punzhayachinmi,  
Ovejaga bila purucuinta man. Chimandami chi  
llactaibi indita quillatahuas mana minishtinzh  
chibi punzhayachingahua.



Chi llactamaga ima jiridsahuas mana  
yaicungachu, imatas huaglichic  
runahuas llullaccunahuas mana  
yaicunaungachu.

Astahuanbas Oveja  
chariushca causana  
quillcaibi  
quillcashcagunallami  
chimaga yaicunaunga.



Diosca paiguna huacashca ñahui  
yacutas pichasha chaquichingami.  
Huañunahuas illangami,  
huacanhahuas, Ilaquirisha  
caparinahuas, nanaigunahuas  
tucuringami. Tucui chi  
ñaupa tiyaccuna ña  
tucurishca manga.



Chimanda chibiga imas juchamanda huaglishca mana  
tiyangachu, illangamiraun. Dios mandasha tiyarinas,  
Oveja mandasha tiyarinahuas chi llactai tiyanaungami.  
Paita llaquiuc runagunaga pai munashcata rashami  
causanaunga. Paihua  
ñahuita ñahuipura  
ricunacungaunami.  
Paihua shutitas  
paiguna urintibi  
churashca  
mangauna.



Chasnallata tucui huañushca runagunata Diospa ñaupacpi shayaucunata ricurani balichishcatas mana balichishcatahuas. Chasna aushcai librogunata pascaushcata ricurani. Shuc libroga huiñai causaita charic runagunahua shutita quillcashca mara, chiga pascashcami ara. Chi shuc librogunaiga tucui huañushca runaguna rashcagunata quillcashca mara.

Dios chi librogunai ricusha paiguna rashca tuputa taripara. Maican runahuas paihua shutita causana quillcaibi mana quillcachishca ashaga chi nina cuchama shitashca tucungami.

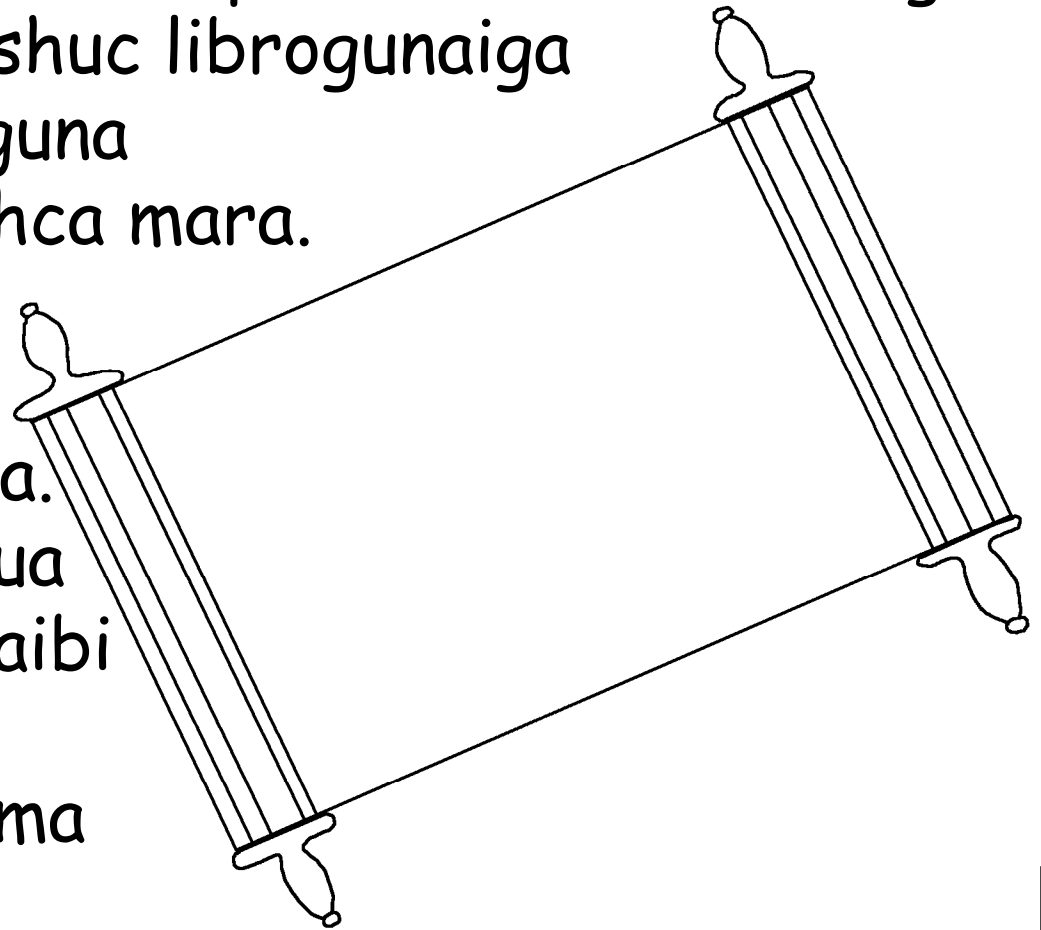

Chasna nicpi Diospa Samaihuas, Ovejahua huarmishina  
quiric runagunahuas shamuilla Jesus, nisha rimanaun.  
Maican caita uyaccunahuas shamuilla nisha rimachun.  
Pihuas upinayaushaga upic shamuchun. Pihuas causaita  
cuc yacuta munashaga mana pagasha yangalla upic  
shamuchun nini.



Yaya Diosca  
cai pachai causac  
runagunata yapa llaquishcamandami  
paihua sapalla churita caima  
cachamushca tucui paita quiric  
runaguna ama ucupachama  
chingarinauchun, astahuanbas  
huiñai causaita  
charinauchun  
nisha.

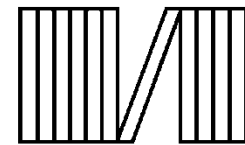

Romanos 3:23

Tucui runagunaga juchata rashcamandami Diospagma  
pactanata mana ushanaunzhu.

Romanos 6:23

Yuyarichi. Juchamanda paganaga huañui man.  
Astahuanbas Dios Ilaquisha cushcaga huiñai causaimi  
ñucanchi Señor Jesucristohuan shuglla tucushcamanda.

Hebreos 9:27

Chicuintallata caran runa shuc cutinlla huañuna manchi.  
Chihuashaga Diospacpi caran shuc ima rashcagunamanda  
taripaitucuna anaun.



## Efesios 2:8,9

Canguna Jesucristota quirishcamandami Yaya Dios cangunata llaquisha quishpichira. Canguna mana imata ranatas ushashcamandallachu quishpichishca tucuranguichi, astahuanbas yangamanda shuc cumbiranata cushcacuintami Dios cangunata quishpichira. Shuc runa pai ushashcamandalla quishpirishaga amullata alabaringa. Ama chasna alabarichun nishami Diosca canguna mana imata rashca acpihuas cangunata quishpichira.

## Romanos 10:9,10

Chimanda camba shimihuan Jesusca ñuca mandac amu man nishaga, Dios paita huañushcamanda cuti causachishcata camba shunguhuan quirishaga quishpichishca tucunguimi. Yuyarichi. Camba shunguhuan sirtu quirishami Dioshuan alichishca tucungui, camba shimihuan Cristoga ñucata mandac amu man nisha rimashami quishpichishca tucungui.



## San Juan 3:16,17

Yaya Diosca cai pachai causac runagunata yapa  
llaquishcamandami paihua sapalla churita caima  
cachamushca tucui paita quiric runaguna ama  
ucupachama chingarinauchun, astahuanbas huiñai  
causaita charinauchun nisha. Yaya Dios mana runagunata  
caudsayachingahuachu paihua churita cachara, randi  
quishpichichun nishami cachara.

## 1 San Juan 5:11-13

Chimandami Yaya Dios casna rimashcata nin: Tucui  
Jesucristota quiriccunama Yaya Dios huiñai causaita  
cushcami. Chi huiñai causanaga paihua churihuagllaimi  
tiyaun. Maican runahuas Diospa churi Jesucristota  
quiricca huiñai causaitami charin, randi Diospa churita  
mana quiricca huiñai causaita mana charinzhu.  
Jesucristota quiriccunama caita quillcauni canguna huiñai  
causaita sirtu charishcataga yachangahua nisha.



San Juan 14; 2 Corintios 5; Apocalipsis 4, 21, 22

Storyline by: Edward D. Hughes

Illustrated by: Lazarus  
and Alastair Paterson

Adapted by: Sarah S.

Quichua, Northern Pastaza NT (qvz) © 2009, Wycliffe  
Bible Translators, Inc. All rights reserved.

<https://live.bible.is/bible/QVZWBT/MAT/1>

©2026 Bible for Children, Inc.

[www.M1914.org](http://www.M1914.org)

[www.bibleforchildren.org](http://www.bibleforchildren.org)

