

Baibuli y'Abaana yaaza kukworeka

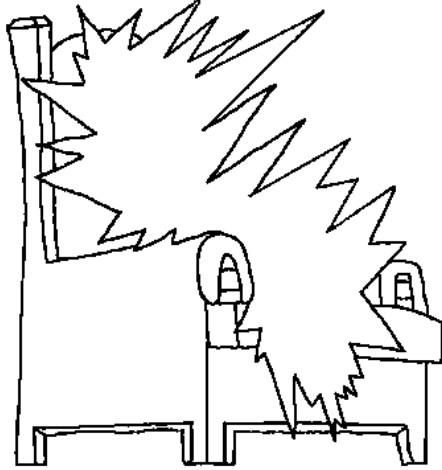

Eiguru Owa Ruhanga



Ekahandiikwa: Edward Hughes
Ebishushani bikateerwa: Lazarus

Ekahindurwa: Z. Kabaza
Ekateekateekwa: Sarah S.

Ekitebyo 60 aha 60

www.M1914.org

Bible for Children, PO Box 3, Winnipeg, MB R3C 2G1 Canada

Noobasa kukopoorora nari okuteera omu kyoma akatabo k'ebigambo ebi, kwonka torikwikirizibwa kukatunda.

Runyankore

Yesu ku yaabaire akiri omu nsi,
yaagambira abeegi be eby'Eiguru.
Akagira ati: "Omu nju ya Tata:
harimu emyanya mingi".
Eiguru nirikira
ensi oburungi.



1

Yesu akagira ati: "Ninza kubashemereza omwanya.
Kandi ku ndaabe ninza kubashemereza omwanya,
ndyagaruka aha, mbatware ei ndi". Ku yaazookire,
yaaza omu iguru. Akatwarwa ahaiguru abeegi be
nibamureeba, ekicu
kyamubakingira.

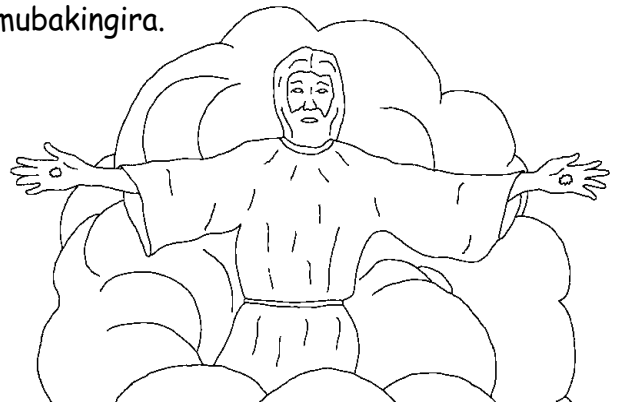

2

Okuruga obwo, Abakristo batuura nibajuka ku Yesu yaaraganiise kugaruka kubatwara. Akagira ngu aryaija kitaraaririire, omu kaanya kakye.

Mbwenu shi Abakristo abafa atakagarukire baryaba bata? Baibuli neetumanyisa ngu ahonaaho baza owa Yesu. Baaba batari mu mubiri, nibaba bari na Mukama.

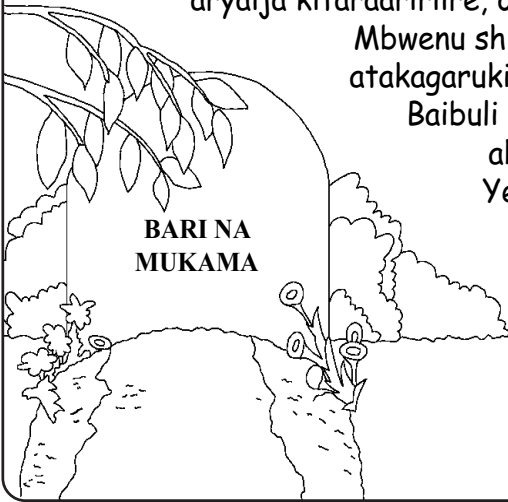

3

Okushuuruurwa, ekitabo ekirikuhereeruka omuri Baibuli, nikitugambira ngu eiguru n'ery'okutangaaza munonga. Ekirikukira okutangaaza n'ahabw'okuba nimwo Ruhanga ataaha. Ruhanga ari hoona, kwonka entebe ye y'obukama etaaha omu iguru.

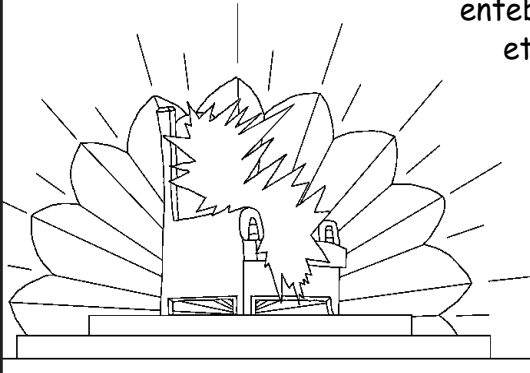

4

Baamaraika n'ebihangirwe byona eby'omu iguru, baramya Ruhanga. Baine ebyeshongoro byabo ebi bahimbisisa Ruhanga.

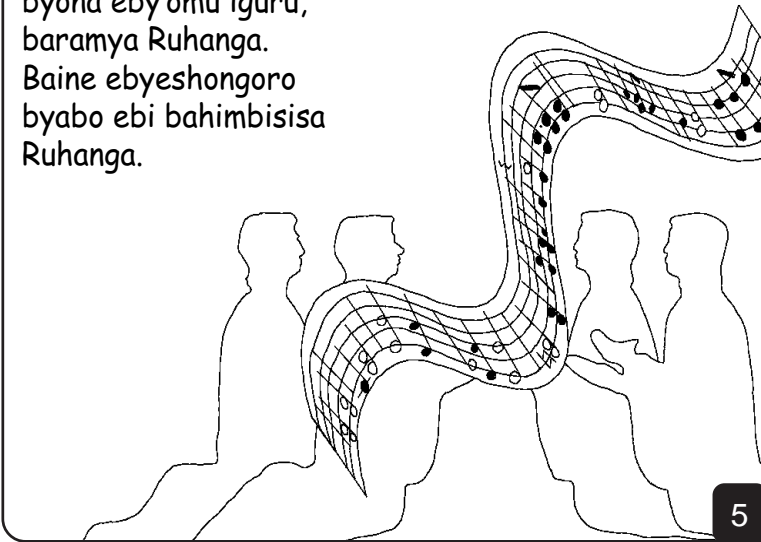

5

Ebigambo ebi biri omuri kimwe aha byeshongoro bi beeshongora: OSHEMEREIRE KUTWARA EKITABO N'OKUBAMBURA OBUMANYISO BWAKYO, AHABW'OKUBA OKAITWA, ...

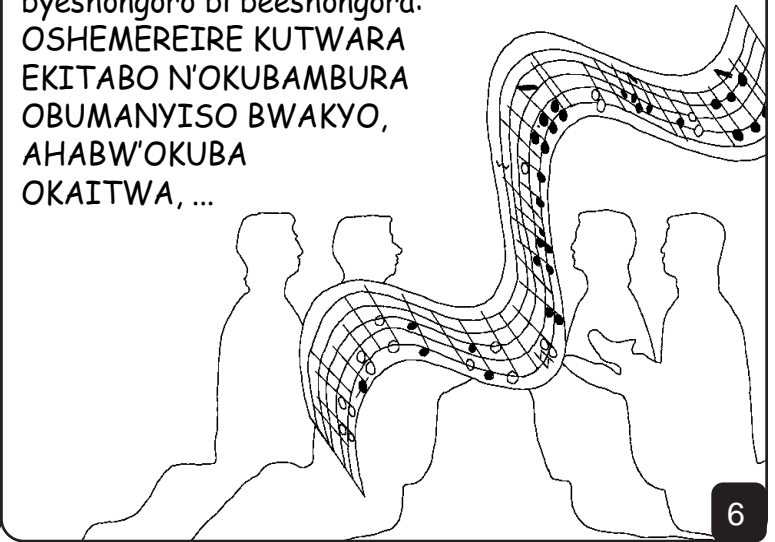

6

... WAACUNGURIRA RUHANGA ABANTU N'ESHAGAMA YAAWE, AB'ENGANDA ZOONA N'ENDIMI ZOONA N'ABANTU BOONA N'AMAHANGA GOONA, WAABAHINDURA OBUKAMA N'ABANYAMURWA AHARI RUHANGA WAITU (Kush 5:9).

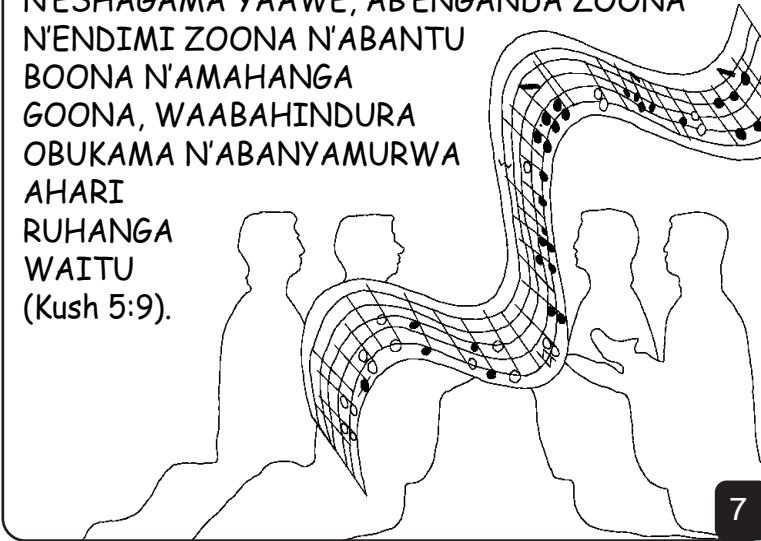

7

Eshuura ezirikuhereeruka omuri Baibuli nizigira ngu Eiguru riine orurembo, "Yerusaalemu ensya". Ni ruhango munonga, munonga, kandi rwehinguririzibwe orugo ruraingwa bwemi. Rwombekirwe amabaare ga yasipi, nirwengyenyeta nk'endeeberwamu.

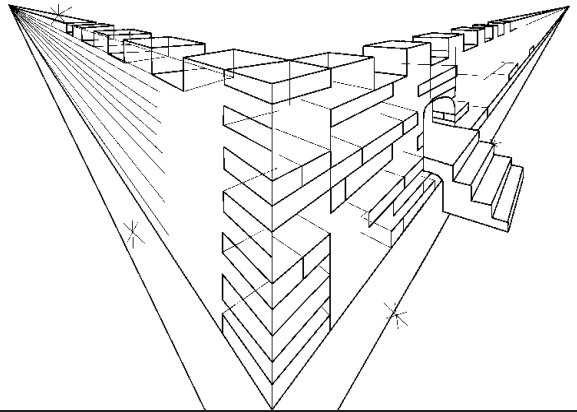

8

Emisingi yaarwo etonire n'amabaare g'emiringo yoona ag'obuguzi bwingi. Rwine amarembo ikumi n'abiri, buri irembo rikozirwe n'eruru emwe mpango.

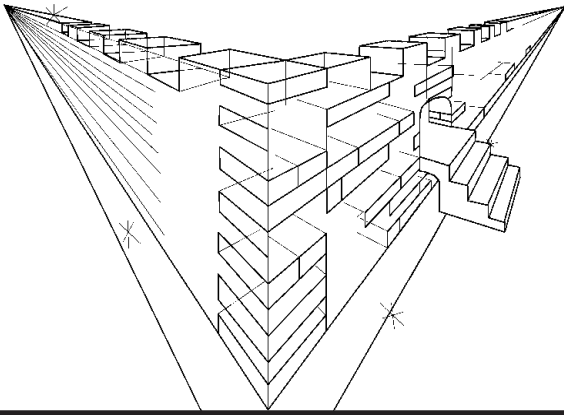

9

Amarembo ago tigakingwa. Rwombekirwe n'enzaabu omunda, kandi enguuto yaarwo ekozirwe n'enzaabu nungi erikwengyenyeta nk'endeberwamu.

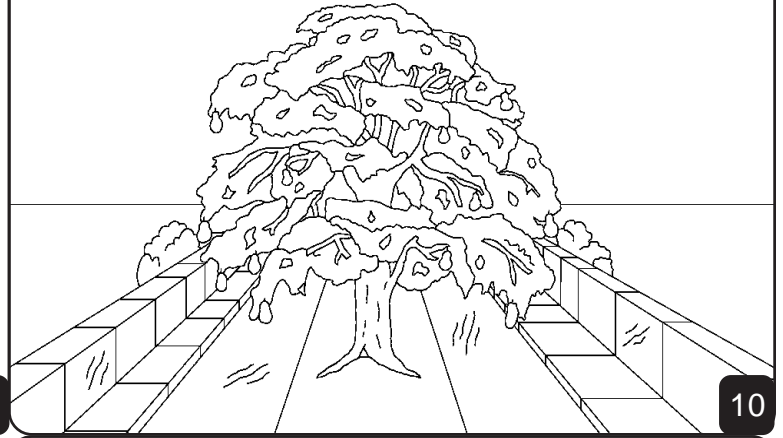

10

Omugyera gw'amaizi g'amagara ogurikwengyenyeta guruga omu kitebe kya Ruhanga eky'obukama. Seeri na Seenu y'ogwo mugyera hariyo omuti gw'amagara. Ijuka ngu n'omu kibanja Edeni hakaba hariyo omuti gw'amagara. Gwo omuti ogu n'ogwo'omutaano. Gwana ebyana by'emiringo ikumi n'ebiri, nigwana ekyana ky'omuringo gumwe buri kwezi, kandi amababi gaagwo nigatambira amahanga.

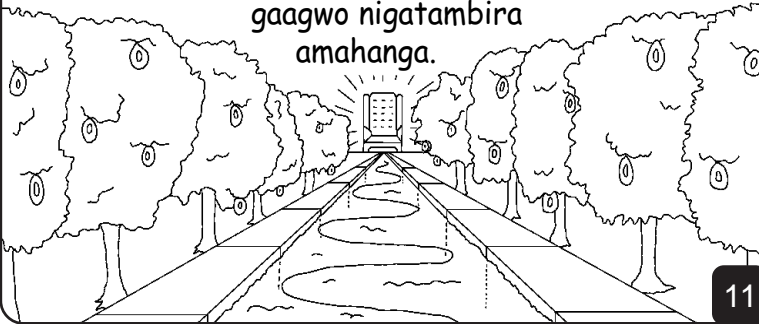

11

Eiguru tiririkwetenga izooba nari okwezi okuryakira. Ekitiinisa kya Ruhanga nikyo kiryakira. Tibwira.

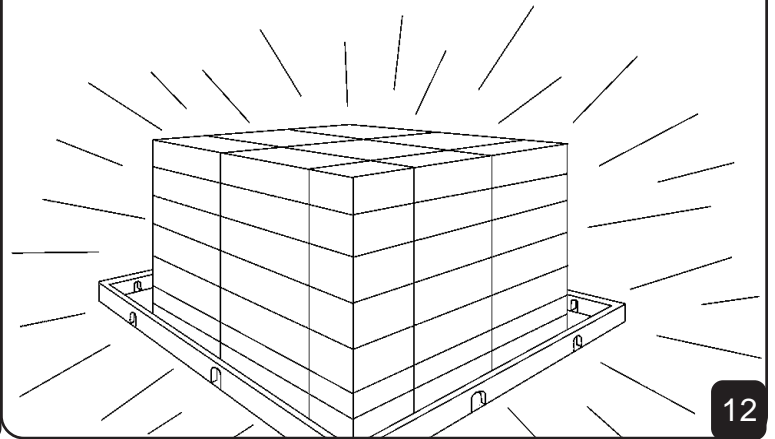

12

Omu iguru hariyo obusingye. Omushega guryataaha n'omwana gw'entaama. Enyana n'entare n'enimi y'ekimasha ekigomokire biryaguma hamwe. Ebyo byona tibirikora kubi, n'obu kwakuba okwita aha rushozi rwangye rwona orurikwera.



13

Haine ebitari mu iguru. Tihariyo kugambisa kiniga. Tihariyo kurwana nari okwefaho wenka. Tihariyo kufuru aha nyigi, ahabw'okuba tihariyo baibi.

Tihariyo abanyabishuba, n'abaitisi b'abantu, n'abarogi, n'obu bakuba ababi ab'emiringo etaagambwa. Manya omu iguru tihariyo kibi kyona.

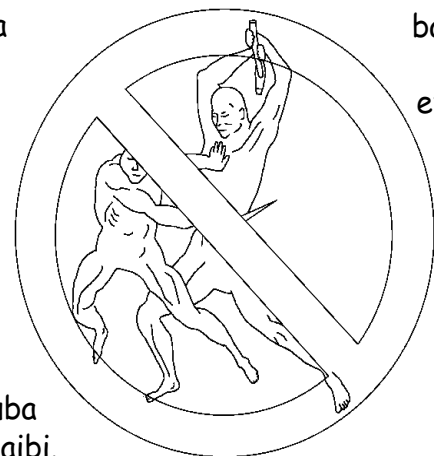

14



Omu iguru abantu tibarira, ahakuba bari ei Ruhanga atuura. Omu nsi omu obundi abantu ba Ruhanga nibarira ahabw'obusaasi butaahamu. Omu iguru Ruhanga aryaragaza amarira goona.

15

Omu iguru okufa nakwo tikubayo. Abantu ba Ruhanga baryaguma na Mukama ebiro byona. Tihariyo naku, nari obusaasi, nari okurira. Tihariyo ndwara, nari okusiibura, nari okuziika. Buri weena oriyo atuura ashemereirwe ahakuba ari hamwe na Ruhanga.



16

Kandi ekirikushemeza munonga, aboojo n'abaishiki bariyo, n'abakuru nabo; abo boona abaikiriize Yesu Kristo Omujuni akabajuna, bakamworobera nka Mukama waabo - boona bariyo. Omu iguru hariyo EKITABO KY'AMAGARA. Kijwire amaziina g'abantu. Noomanya abu amaziina gaabo gahandiikirwemu? Abantu boona abaayesigire Yesu. Eizina ryawe ririmu?



17

Ebigambo eby'aha muheru gwa Baibuli n'okweta kurungi kw'embabazi. "Omwoyo n'Omugore nibagira bati: IJA! Orikuhurira agire ati: IJA! Oine eiriho aije; kandi weena orikwenda atwarire busha amaizi g'amagara."

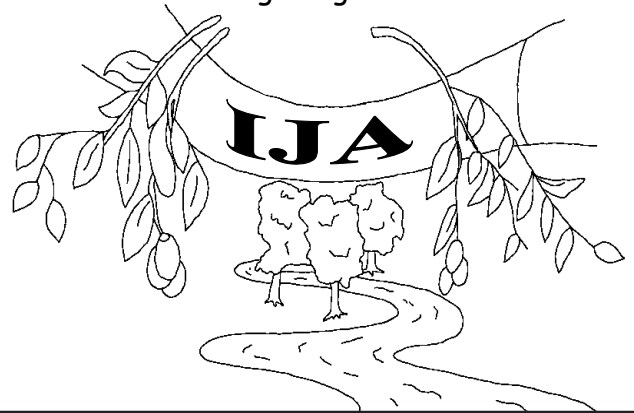

18

Eiguru Owa Ruhanga

Ebi bihirwe omu Kigambo kya Ruhanga, Baibuli

bishange omu

Yohaana 14; 2 Abakorinso 5;
Okushuururwa 4, 21, 22

"Ebigambo byawe ku bishuururwa bireeta omushana." Zaaburi 119:130

Ruhanga naamanya ku turi abasiisi, nitukora ebibi. Ebihembo by'ekibi n'okufa.

Ruhanga atukunda munonga, nikyo yaayohereze Omwana we, Yesu, kutufeera aha musharaba okuba omutango gwaitu. **Akazooka yaagaruka** omu Iguru! N'ahabw'ekyo Ruhanga naabaasa kutusaasira ebibi byaitu.

Ku oraabe nooyenda kweteisa ebibi byawe, shaba Ruhanga oti: Ai Ruhanga, ninyikiriza ku Yesu yanfeereire akazooka, hati ariho. Ninkweshengyereza oije omu magara gangye, kandi onsaasire ebibi byangye, mbone kugira amagara masya, bwanyima ntaahe naiwe ebiro byona. Ompwere ngyende n'omwana waawe. Amiina.
Yohaana 3:16

Shoma Baibuli ogambe na Ruhanga buri Izooba.