

Alkitab kanggo murangkalih Nyanggakeun

Samuel,
Budak-Badega
Gusti



Ditulis ku: Edward Hughes

Ilustrasi/juru gambar ku:
Janie Forest, Alastair Paterson

Disaluyukeun ku: Lyn Doerksen

Ditarjamahkeun ku: Kurnia Arifin

Diproduksi ku: Bible for Children
www.M1914.org

©2023 Bible for Children, Inc.

Lisensi: Saderek ngagaduhan hak kanggo ngopy atanapi nyetak carita ieu, salami sanes kanggo tujuan komersil.



Hannah éta awéwé bageur, nikah ka Elkana, lalaki anu bageur oge. Duanana nyembah ka Allah jeung némbongkeun kahadean hirup ka batur. Tapi aya anu leungit tina kahirupan Hannah. Manéhna teh hayang pisan boga orok.

Ah, hoyong pisan manéhna gaduh orok! Anjeunna ngantosan bari jeung ngado'a sareng ngarep-ngarep ngantosan deui. Orok teh taya datang!

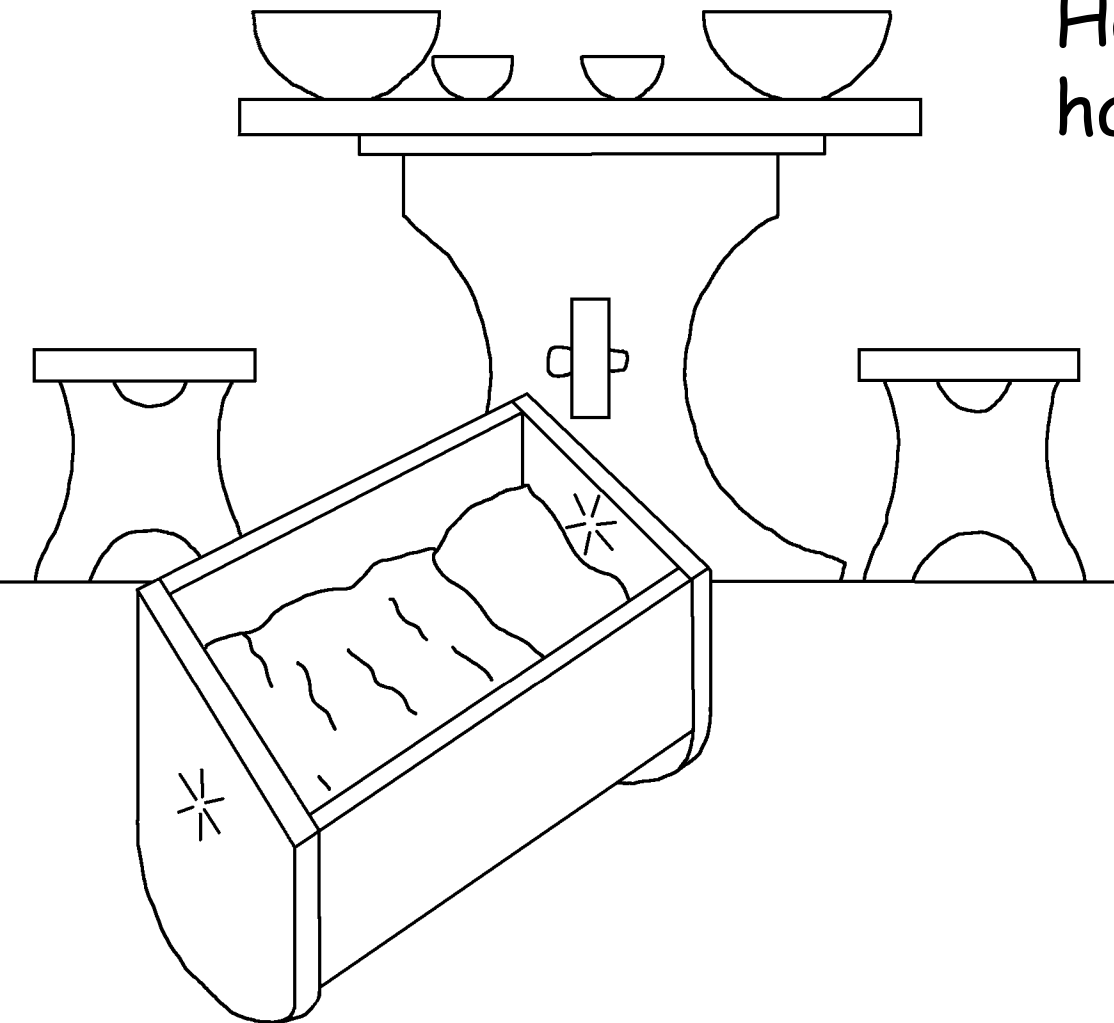

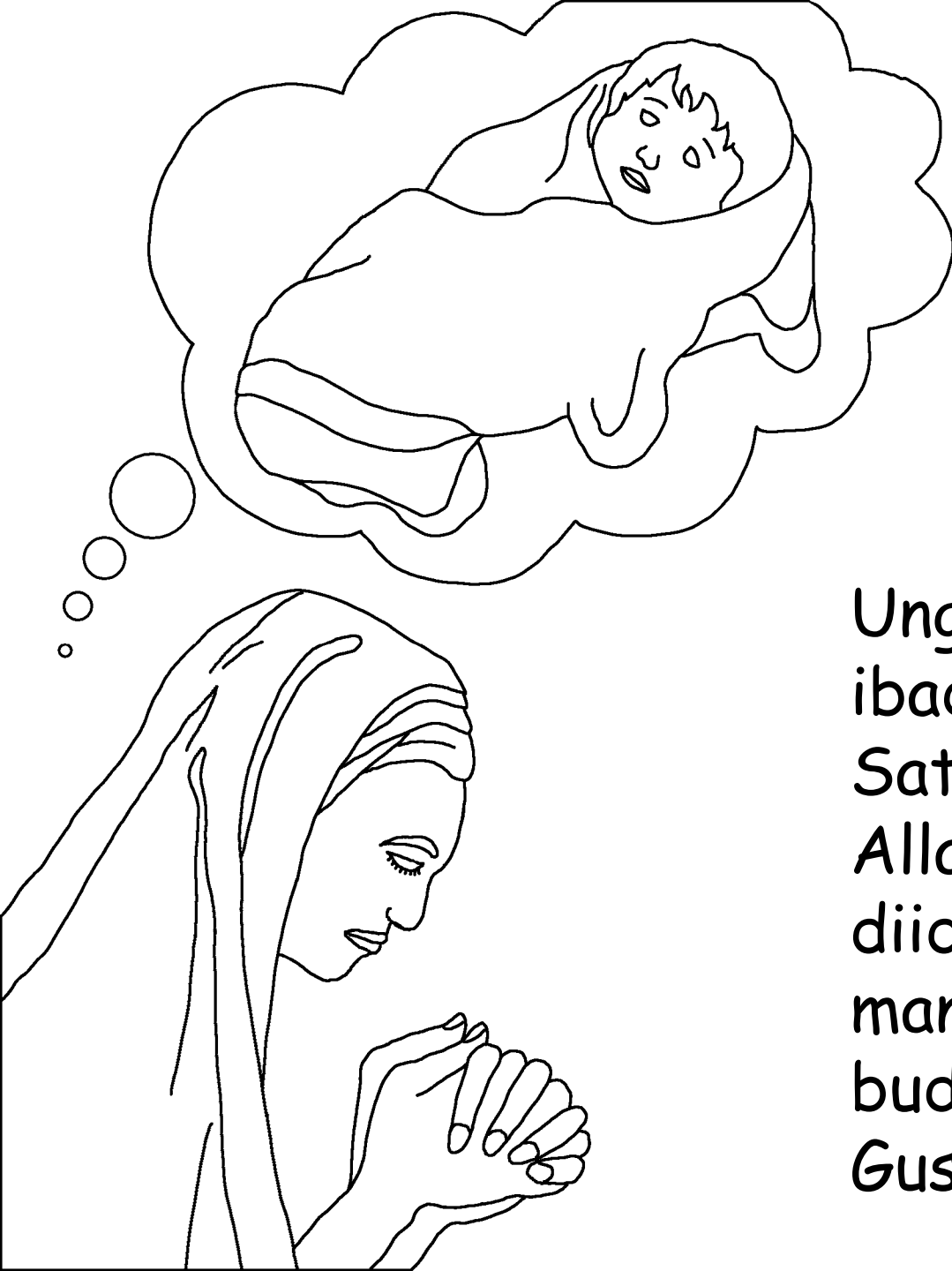

Unggal taun, Hana indit ibadah di Kemah Allah. Sataun manéhna jangji ka Allah yén lamun Mantenna diidinan boga anak lalaki, manéhna bakal mere budak éta jadi badega Gusti salawasna.



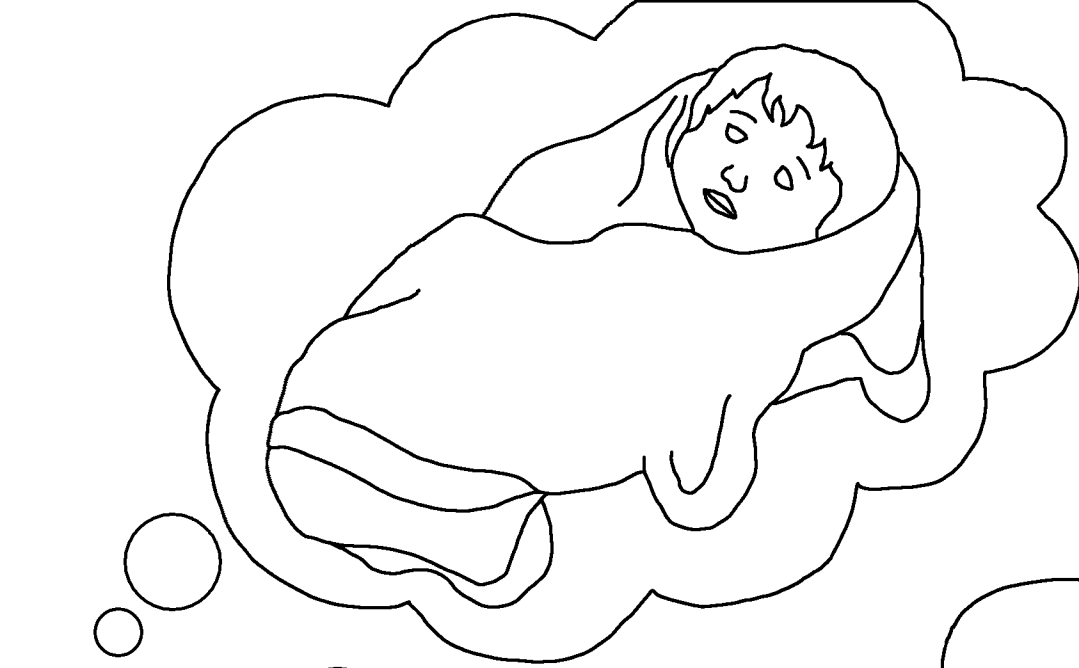

Eli, Imam nu sepuh
ningali Hana keur
sembahyang.
Dikintenna Hannah
mabok anggur sabab
biwirna ting
pakecewis tapi
teu aya sora.
Eli nyentak
Hannah!



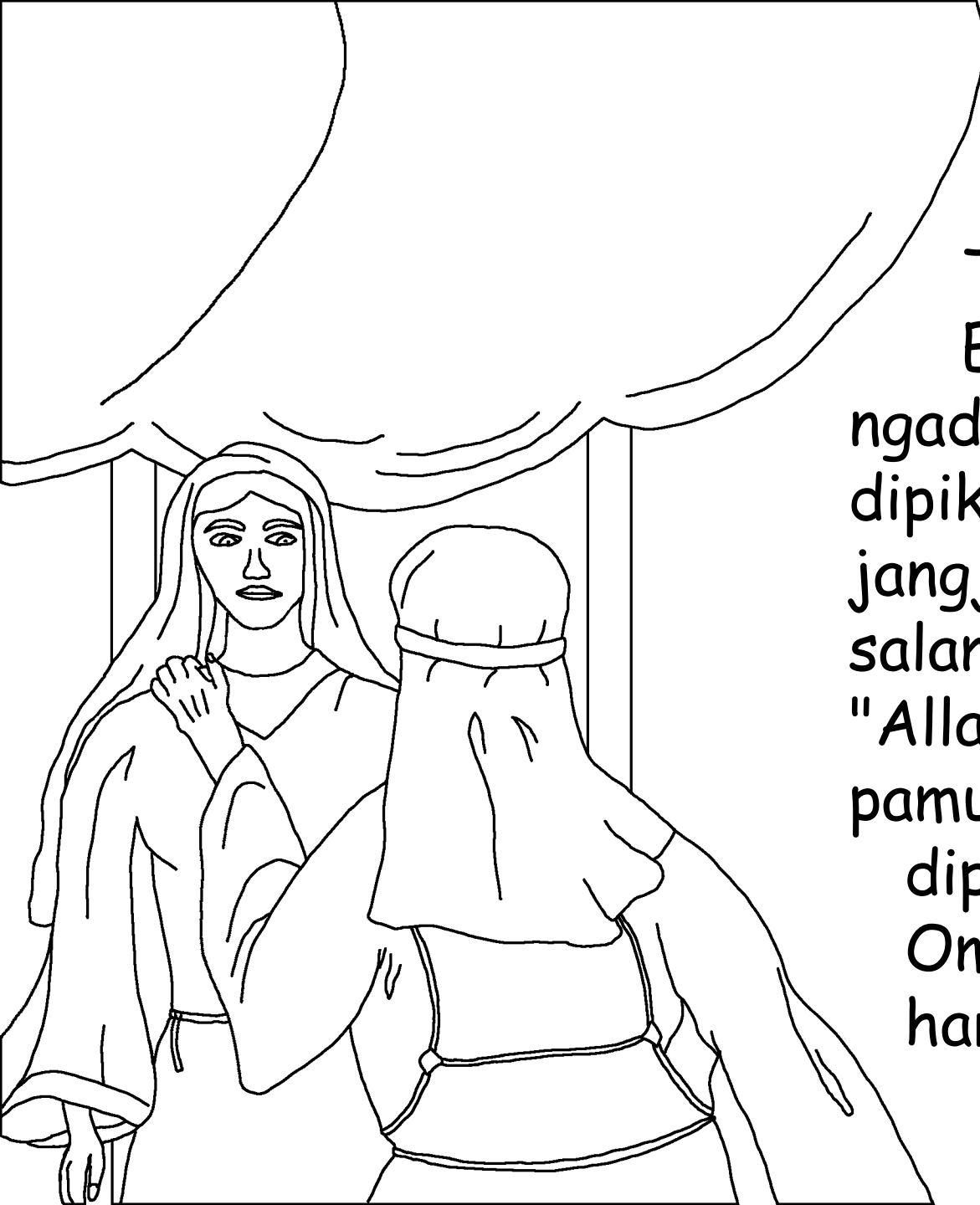

Tapi Hana nyarios ka Eli yen manehna keur ngadoa kanggo orok anu dipikahayang sareng jangjina ka Allah. "Tos salamet," saur Eli. "Allah Israil ngabulkeun pamundut anjeun nu geus dipenta ka Anjeunna." Omongan Eli teh méré harepan pisan ka Hana.



Moal lami deui kabingahan nu hébat bakal ngeusian haté Hana. "PANGERAN émut ka anjeunna" sareng ngawaler doana. Manéhna jeung Elkana boga budak leutik nu ngaranna Samuel (anu hartina "Kadangu ku Allah"). Tapi dupi Hana bakal inget henteu ka Allah jeung jangjina ka Mantenna?

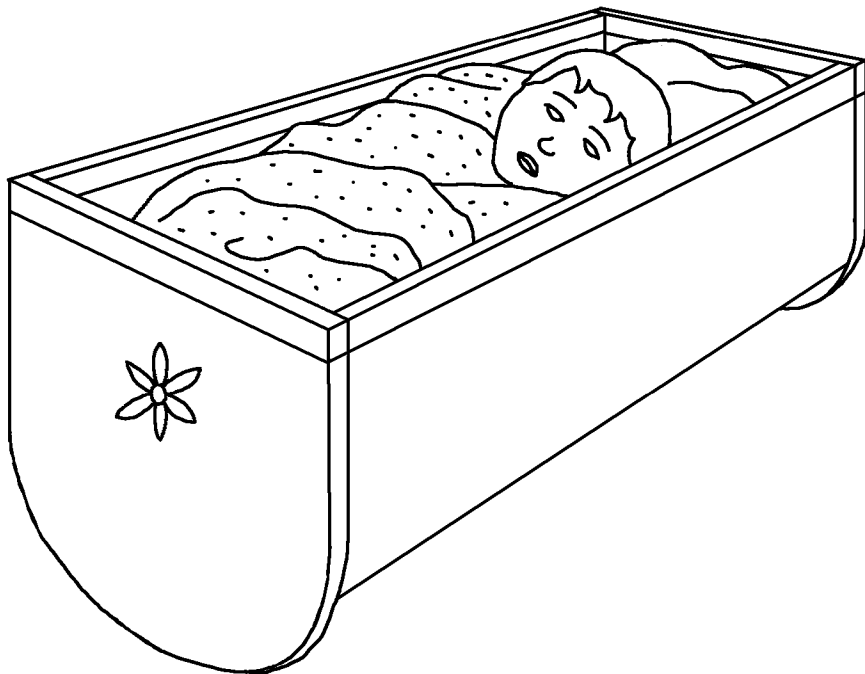



Hana teh ngeureunan indit ka Kemah Suci unggal taun. Ya ampun! Naha anjeunna mungkir jangji ka Allah? Henteu, Hana ngantosan nepi ka Samuél cukup umur pikeun cicing di gedong Pangeran jeung mantuan Eli ngawula ka Allah. Saterusna manéhna dibawa ka Kemah.



Allah teh hormat sarta bungah kana kasatiaan Hana. Saatos Samuel, Allah masihan anjeunna tilu deui putra sareng dua putri. Unggal taun, Hana indit ka Kemah Suci pikeun nyembah ka Allah - sarta mawa jubah anyar anu dijieun ku manéhna pikeun Samuel.



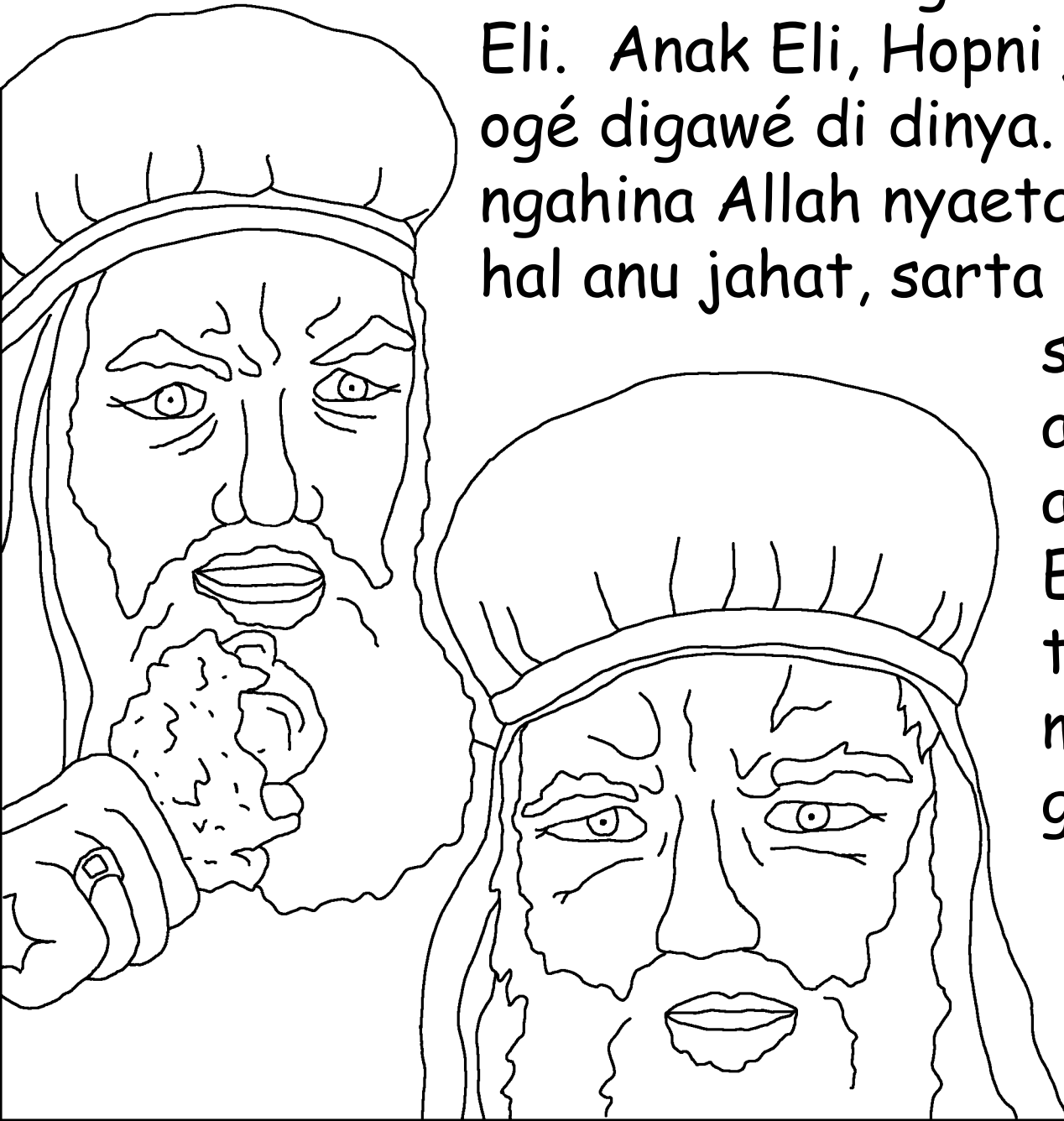

Samuel sanés ngan ukur ngabantosan Eli. Anak Eli, Hopni jeung Pinehas, ogé digawé di dinya. Tapi maranéhna ngahina Allah nyaeta ngalakukeun hal-hal anu jahat, sarta moal robah

sanajan bapana anu menta ka aranjeunna. Eli kuduna mah tos ngeureuan maranehanna tina gawé di Kemah Suci teh. Tapi eta teh teu dilampahkeun.



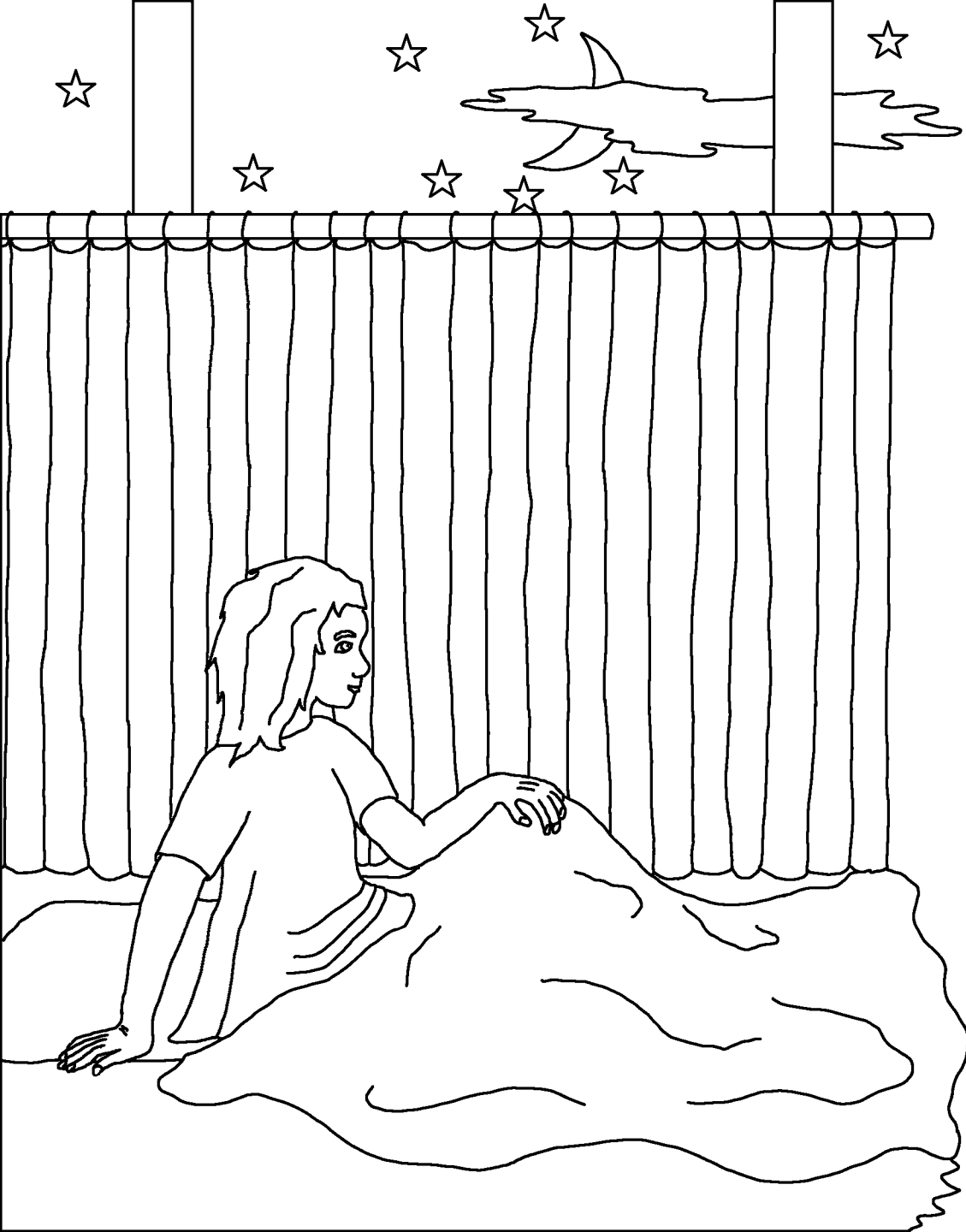

Hiji peuting,
Samuel ngadéngé
aya sora ngageroan
manéhna. Budak
éta nyangka yén Eli
nu sasauran. "Di
dieu kuring," pokna.
"Kuring henteu
sasauran," jawab
Eli. Ieu teh
lumangsung tilu
kali. Tuluy Eli
nyaho yén Allah
rék nyarita ka
Samuel.



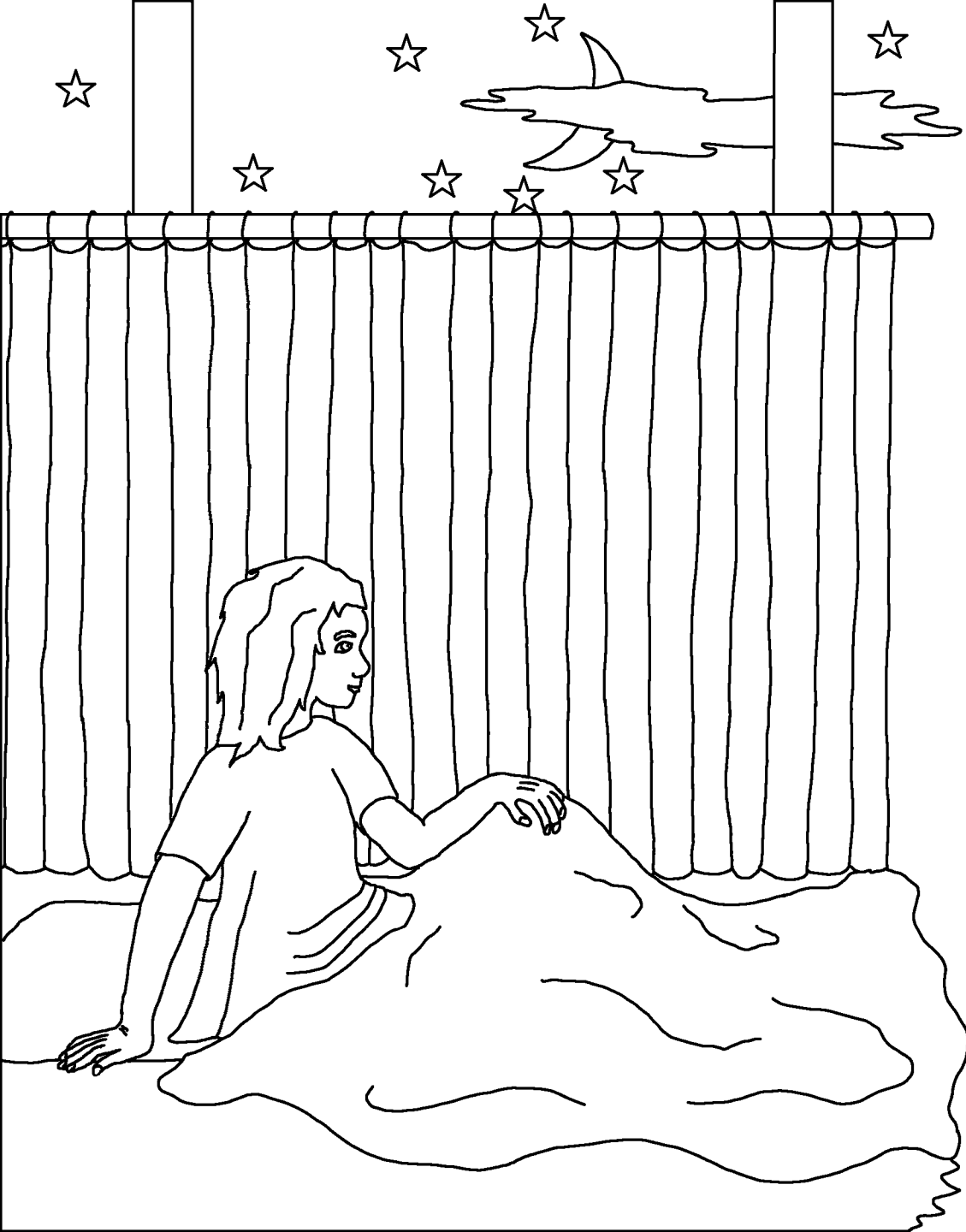

Eli ngabejaan Samuel, "Lamun Mantenna nyaur ka maneh, maneh kudu ngucap, 'Nyaritakeun GUSTI, sabab kaula nguping.'" Jeung Allah sasauran deui, sarta maparin amanat anu kacida pentingna.



Isuk-isuk Eli nyauran Samuel. "Naon anu didawuhkeun ku GUSTI ka anjeun?" saur Eli. Si anom Samuel ngawartoskeun anjeunna sagalana. Ieu pesen anu pikareueuseun - Allah bakal ngancurkeun kulawarga Eli margi Hopni sareng Pinehas teh kacida jahat pisan.



Pangeling-eling Gusti estu leres. Dina mangsa perang jeung urang Pelisti, dua putra Eli nu jahat mingpin Peti Perjangjian di payuneun tangtara Israil. Musuh nyandak eta Peti Perjangjian tuluy maehan Hopni sareng Pinehas sareng seueur deui urang Israil. Nalika Eli ngadéngé éta, anjeunna murag tina korsi, pateuh beuheungna, tuluy maot dinten harita keneh.



Peti Perjangjian Allah nimbulkeun kasusah ka urang Pelisti. Eta teh disimpen di kuil Dagon, dewa palsu maranéhna. Isuk-isuk, arca Dagon murag. Urang Pelisti ngangkat Dagon - tapi isukna eta dagon murag deui. Ayeuna mah eta Dagon teh ancur remuk.

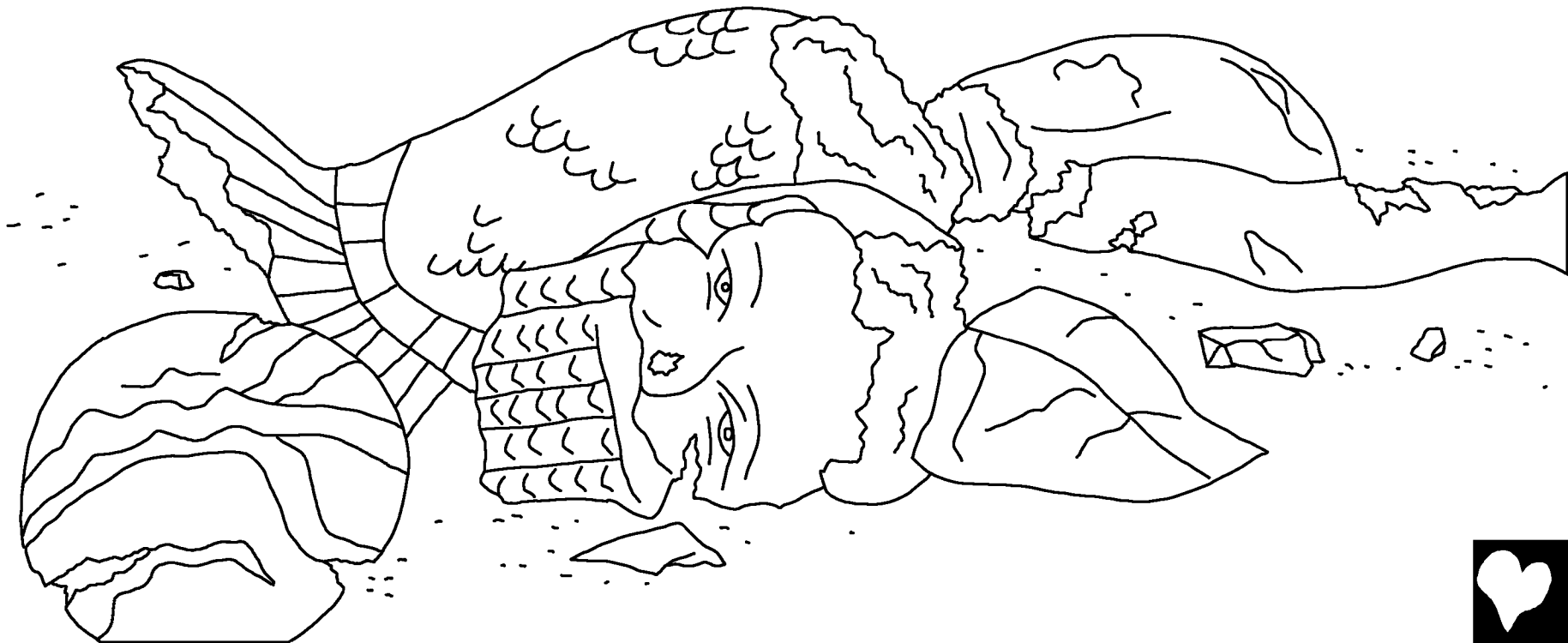



Panyakit jeung kamaotan sumebar di antara urang Pelisti. Pikeun ningali naha Allah ngahukum aranjeunna, urang Pelisti ngintunkeun dua sapi pikeun narik kareta anu aya dina peti. Tapi aranjeunna ngangkat anak sapi. "Lamun sapi indit ka Israil, sarta ninggalkeun anak sapi maranéhanana, urang bakal nyaho yen Allah anu migawé eta," ceuk maranehna. Jeung sapi teh naraék!



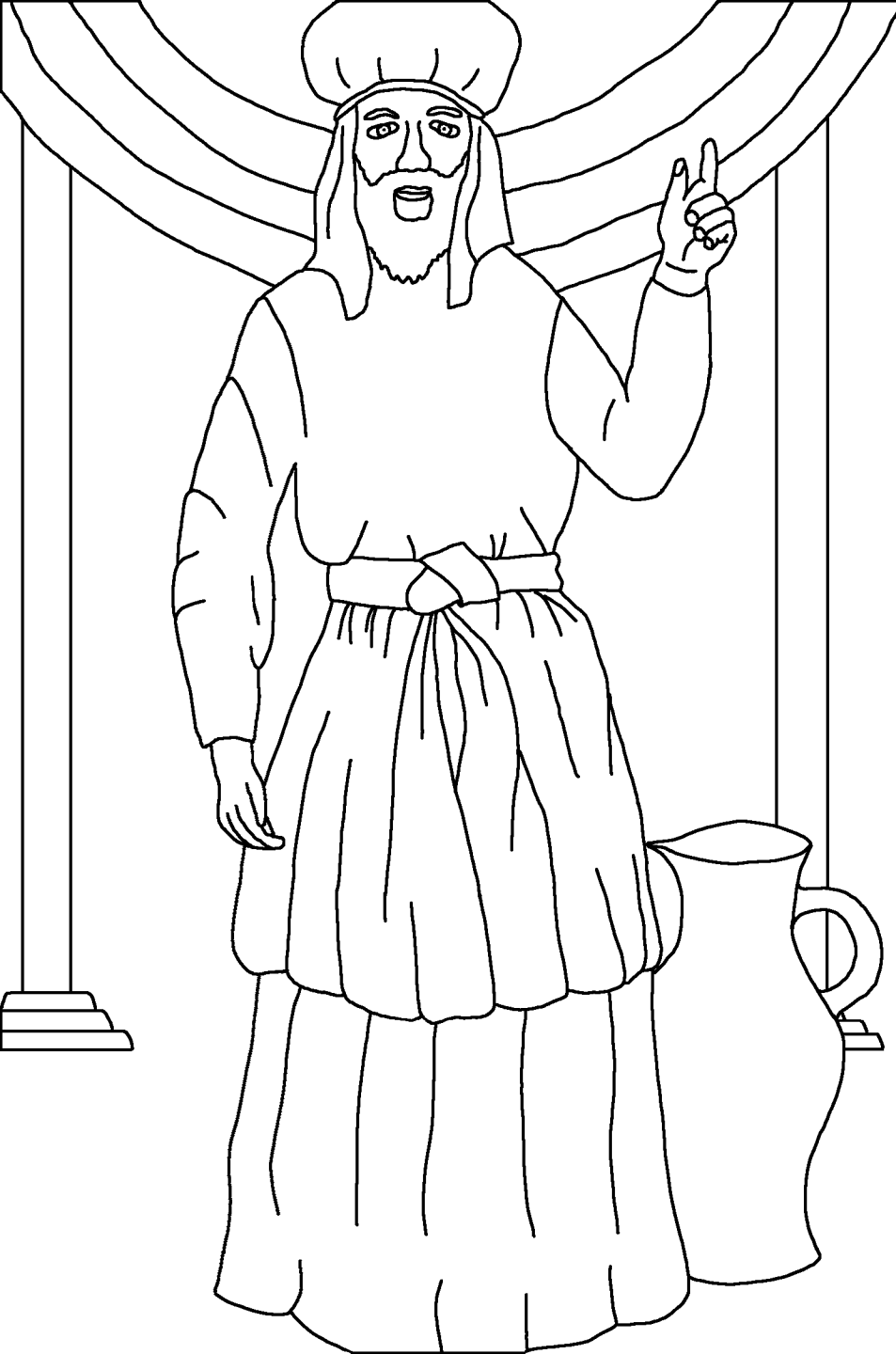

Saterusna Samuel, anu ayeuna geus dewasa, nyarita ka sakabeh urang Israil. "Lamun ayeuna maneh baralik deui ka PANGERAN jeung sakabeh haté anjeun ... Mantenna bakal nyalametkeun anjeun tina bangsa Palesti." Jalma-jalma eta nurut ka eta nabi Allah anu satia. Jeung panangan Gusti ieu ngalawan Palesti unggal poé di jaman Samuel.



Samuel, Budak-Badega Gusti

Carita tina Dawuhan Gusti, Alkitab

Kenging ti

1 Samuel 1-7

"Ngawitan bubukana Dawuhan Gusti anu
masihan Caang." Psalm 119:130



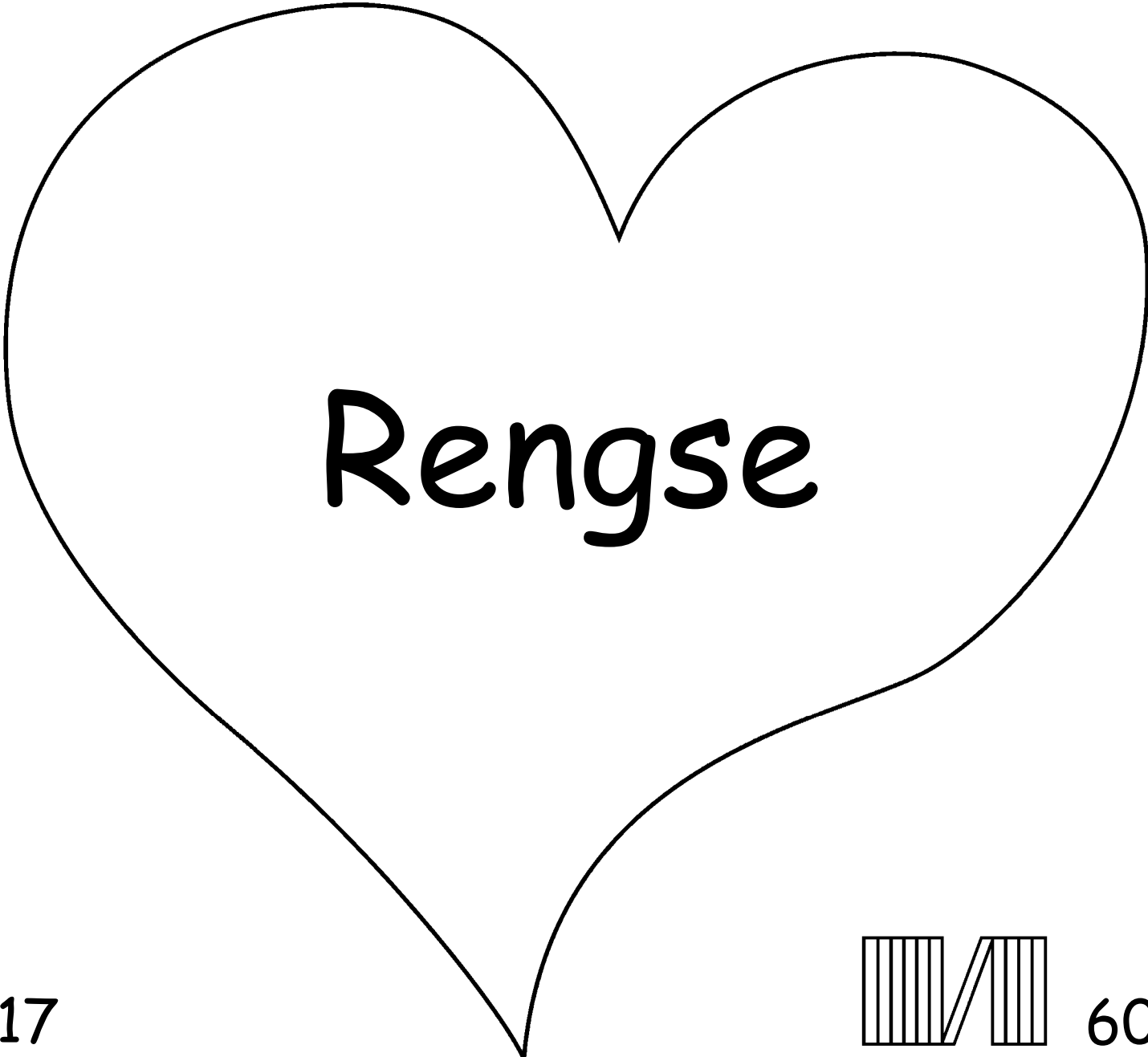

17

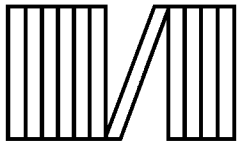

60



Kisah Kitab Suci/Alkitab ieu nyarioskeun kasaean Gusti anu tos ngajantenkeun urang, sareng anu mikahoyong sangkan urang tiasa wanoh ka Anjeuna.

Gusti uningaen yen urang teh tos seueur milampah kasalahan, anu ku Mantena disebut dosa. Hukuman akibat tina dosa teh nyaeta pati, tapi Gusti Allah kacida mikanyaah Saderek dugika ngutus Putrana Yesus, kanggo pupus dina kai palang teras dihukum kumargi sagala dosa Saderek. Teras Yesus gugah deui sareng diangkat ka sawarga! Upami Saderek percanten ka Yesus tur neneda ka Anjeuna supados ngahampura sagala dosa Saderek, Anjeuna baris ngalaksanakeun panuhun Saderek eta! Anjeuna bakal sumping sareng linggih di lebet Saderek ayeuna keneh oge, tur Saderek bakal sasarengan sareng Anjeuna salalamina.

Upami Saderek percanten yen ieu sadaya teh hiji bebeneran, saurkeun ka Gusti sapertos kieu:

Nun Yesus, abdi percanten yen Anjeun teh Gusti, anu mijalma janten manusa tur pupus kanggo sagala dosa abdi, ayeuna Anjeun hirup deui. Sumangga sumping dina kahirupan sim abdi, hapunten sagala dosa abdi, supados abdi tiasa ngengingkeun hirup anu anyar, tur engke dina hiji waktos bakal sasarengan sareng Anjeun salalamina. Tuyun sim abdi supados taat mung ka Anjeun, teras abdi tiasa hirup kanggo Anjeun, salaku Putra Gusti, Amin.

Aos Kitab Suci sareng teras cumarios ka Gusti unggal dinten! Yohanes 3:16

