

Alkitab kanggo murangkalih Nyanggakeun

Yunus jeung Lauk Gede



Ditulis ku: Edward Hughes

Ilustrasi/juru gambar ku:
Jonathan Hay

Disaluyukeun ku: Mary-Anne S.

Ditarjamahkeun ku: Kurnia Arifin

Diproduksi ku: Bible for Children
www.M1914.org

©2023 Bible for Children, Inc.

Lisensi: Saderek ngagaduhan hak kanggo ngopy atanapi nyetak carita ieu, salami sanes kanggo tujuan komersil.



Mangtaun-taun katukang, aya hiji
jelema ngaranna Yunus cicing di
tanah Israil. Hiji poé, Allah
nitah manéhna indit
ka Ninewe,

kota
panggedéna jeung
pangkuatna di dunya.
Yunus kudu ngingetkeun
ka sakabeh jalma di
dinya yen Allah uninga
kumaha jahat maranéhanana.



Yunus henteu taat ka Allah!
Tibatana indit ka Ninewe, Yunus
naek kana kapal jeung balayar
ka arah nu lalawanan ka hiji
tempat nu disebut Tarsis.

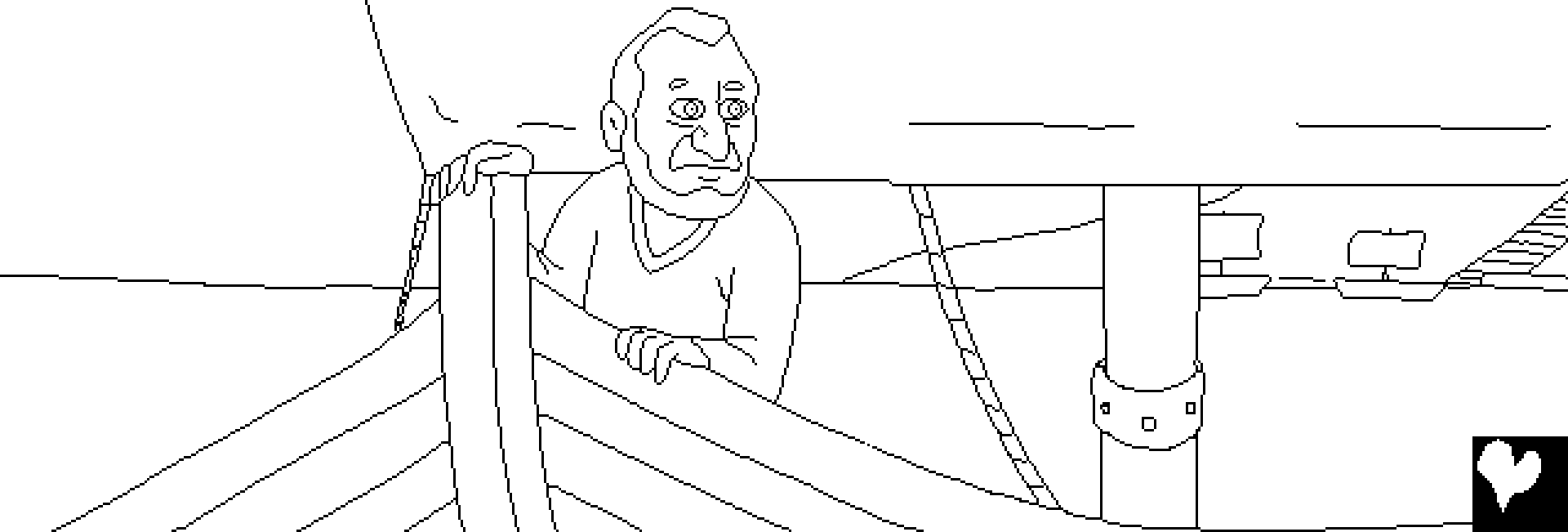

Allah ngadatangkeun angin ribut ka laut anu matak topan kacida gedena! Jalma-jalma nu dina kapal hariwang yén kapal éta bakal beulah tuluy tilelep.

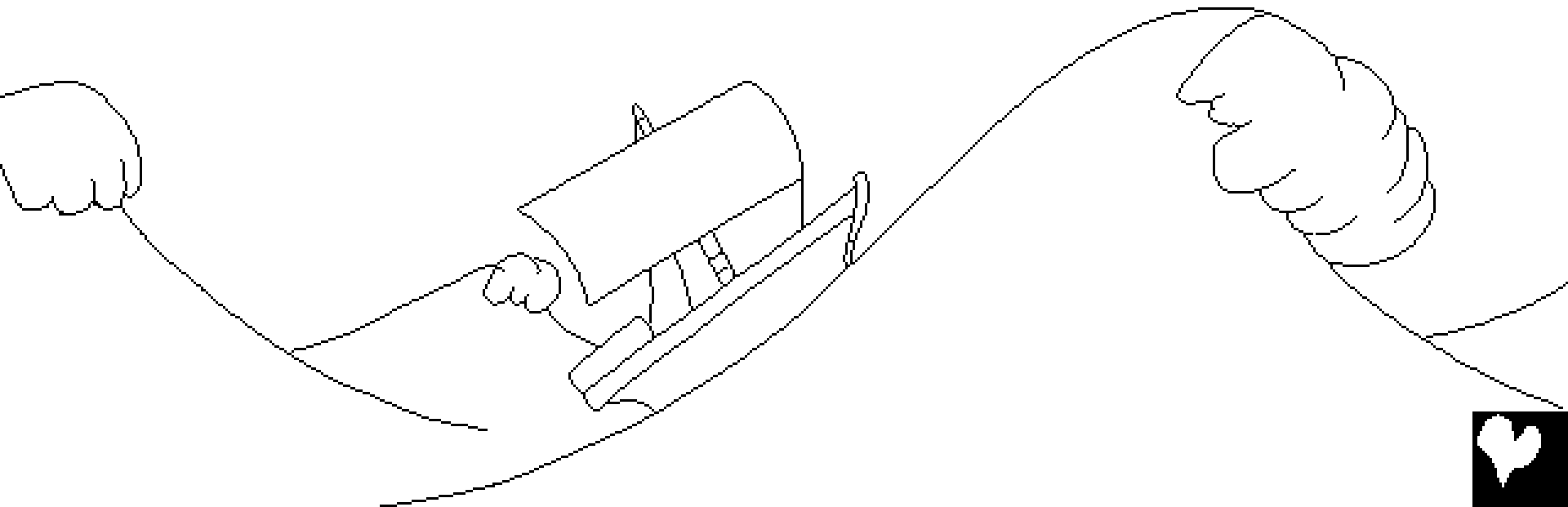

Badai teh beuki parah. Matros-matros teh sieun pisan, tuluy sasambat ka dewa-dewana sareng ngabalang-balangkeun sadaya barang bawaan ka laut pikeun ngaringankeun kapal. Tapi teu aya nu mantuan.



Yunus hiji-hijina jalma dina kapal nu teu ngadoa.
Gantina, anjeunna ngagolér dina parahu, saré pules.
Kaptén kapal mendakanana. "Naha kalah saré?
Hudang! Geura ngadoa ka Gusti anjeun! Meureun
Allah bakal mikir ka urang, supaya urang teu rubuh."

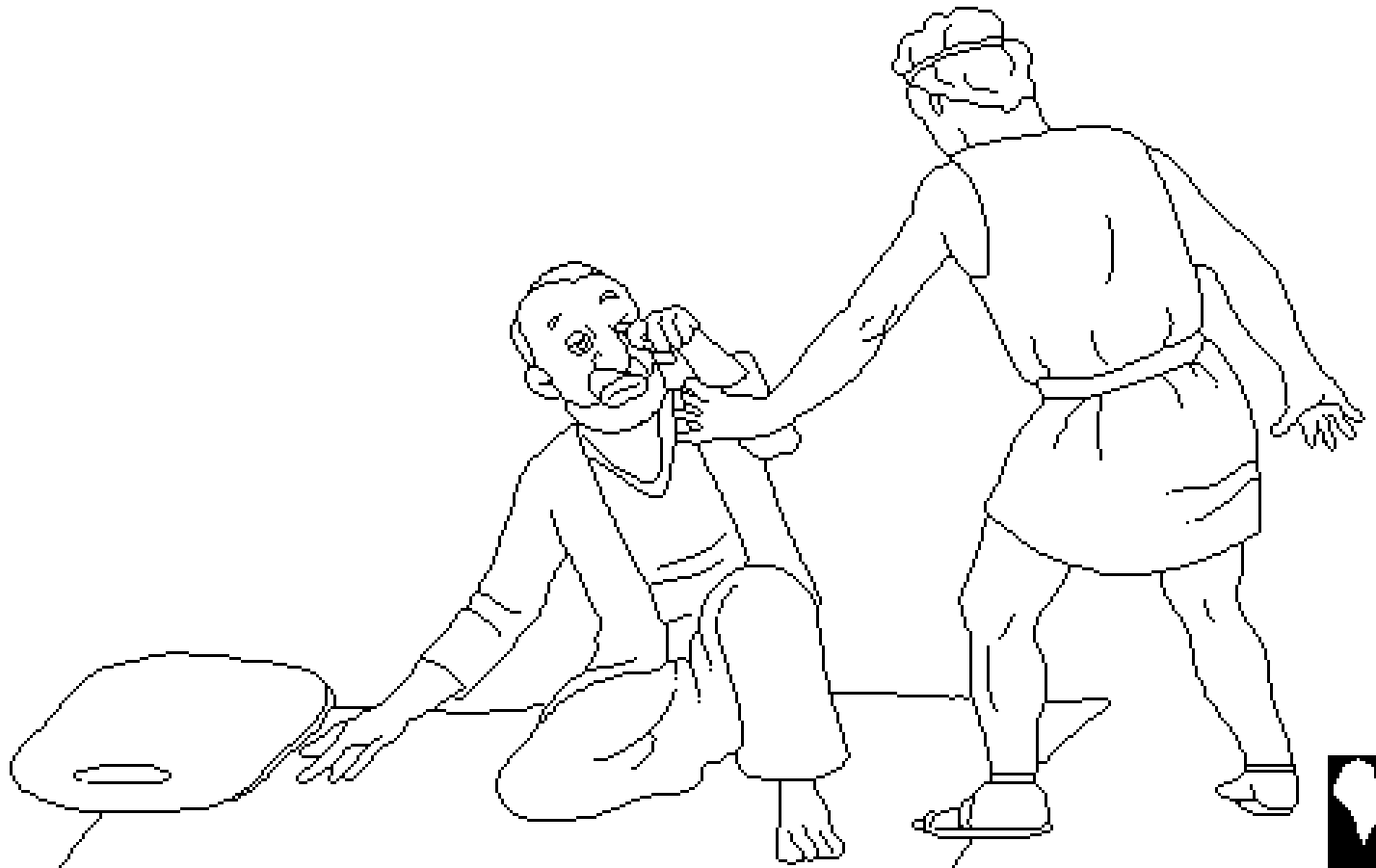

Para pelaut geura-giru mutuskeun yén masalah maranéhanana aya hubunganana jeung Yunus. Tos kaucap yén manéhna kabur ti Allah. Aranjeunna naros, "Naon anu kedah kami lampahkeun supados laut janten tenang pikeun kami?" "Angkat abdi, piceun abdi ka laut," waler Yunus. "Kanggo kuring yakin yén kusabab kuring badai hébat ieu datang ka anjeun."



Para pelaut henteu hoyong ngalungkeun Yunus ka laut. Ku sabab kitu, aranjeunna ngadayung pisan pikeun mawa kapal ka darat. Tapi maranéhna teu bisa. Aya ngan hiji hal pikeun ngalakukeun!

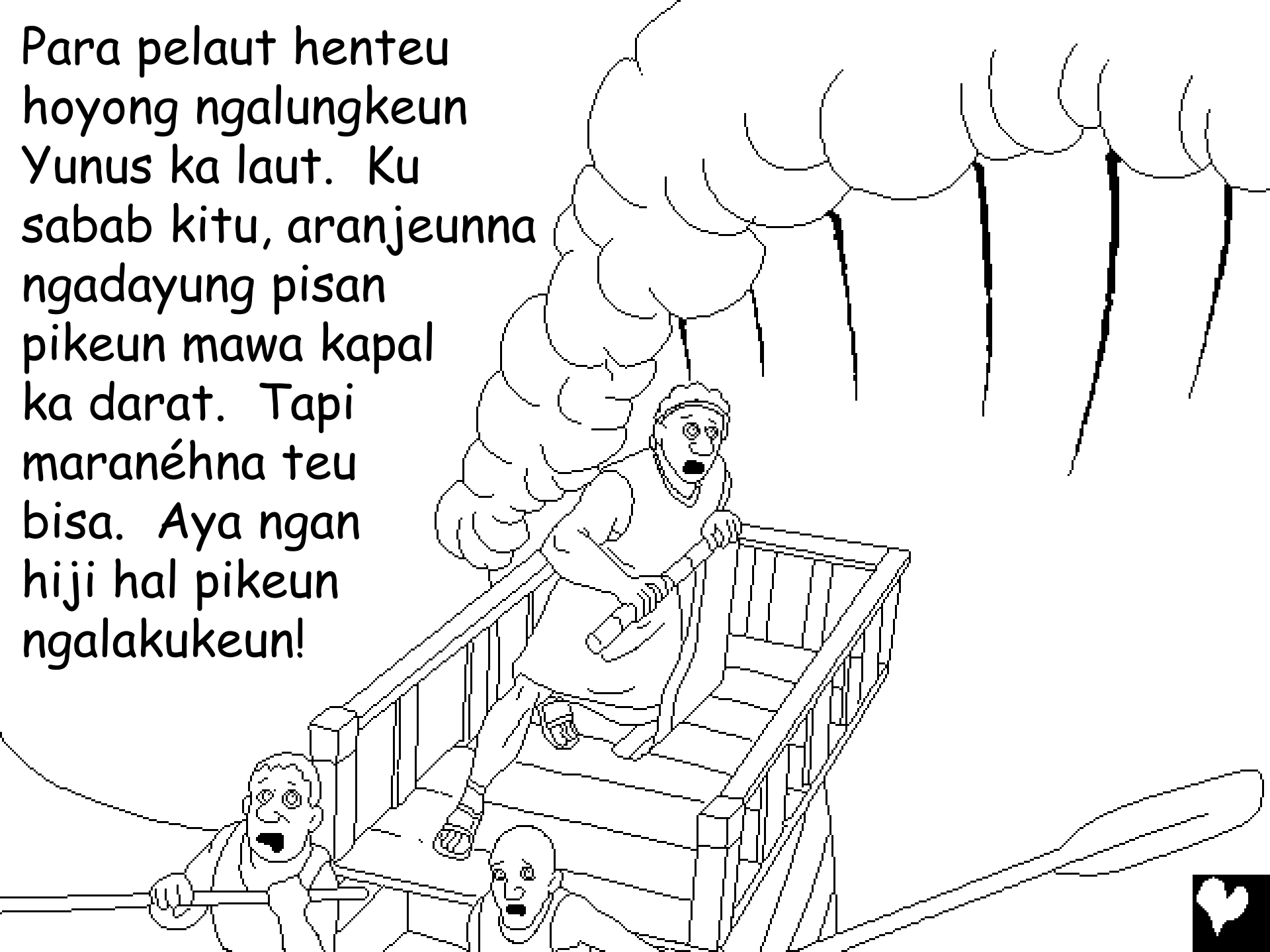

Saparantos neneda pangampura, para pelaut
ngangkat Yunus, dijungjungkeun
ka sisi. Nalika
Yunus leungit
ka handap
ombak, laut
jadi tiis jeung angin tos
teu aya. Parobahan cuaca
anu ngadadak teh matak sieun
pelaut leuwih ti badai.
Maranéhanana kudu geus
nyaho ngan Allah bisa
ngalakukeun eta. Ku
sieun jeung heran,
maranéhna nyembah
ka ALLAH.

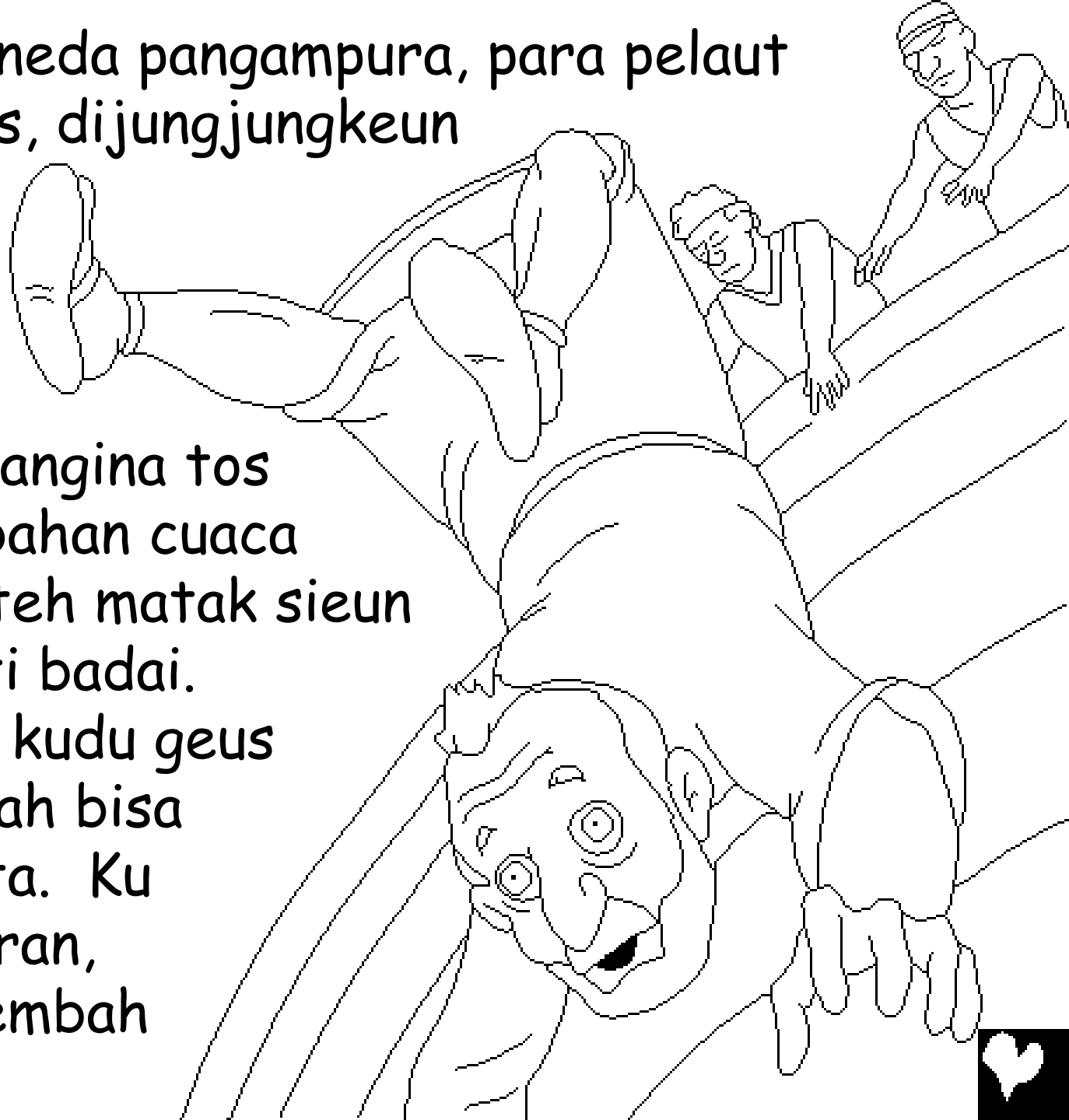

Utusan anu durhaka eta
teh ngadadak reuwas
kacida. Tilelep
tanpa daya dina jero
laut, Yunus terang
teu aya anu tiasa
nyalametkeun anjeunna.
Anjeunna bakal
tilelep - tapi aya
rencana Allah
nu séjén.

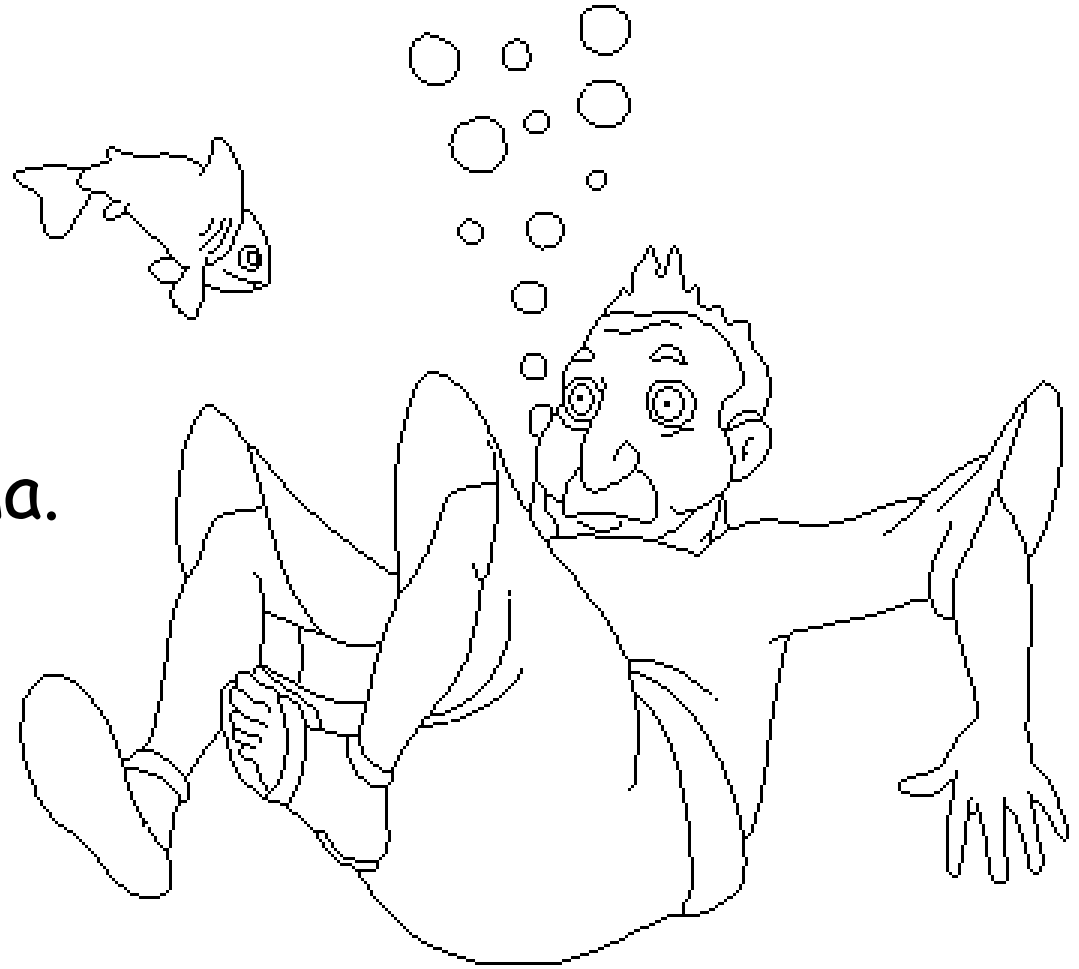

PANGERAN geus nyiapkeun lauk gede pikeun ngelek Yunus. Jol lauk éta dina waktu anu pas! Sakali teureuy Yunus asup kana beuteung lauk. Yunus cicing dina jero lauk salila tilu poé. Aya waktos nu cekap pikeun anjeunna mikir tur ngadoa.



Tilu poe ti harita, Yunus ahirna jangji bakal nurut ka Allah. Geuwat, Allah ngandika ka lauk, Yunus dilepehkeun ka basisir.



Sakali deui, Allah nitah Yunus indit ka Ninewe,
ngawawarkeun pangandika Allah. Ayeuna mah,
Yunus angkat! Yunus asup ka jero kota bari
ngagorowok, "Dina opat puluh poe, Ninewe
bakal digulingkeun."



Urang Ninewe percaya kana firman Allah.
Maranéhna teu dahar, sarta maké karung pikeun
némbongkeun ka Allah yén maranéhna ngaku
kaduhung kana dosa-dosana. Malah raja turun tina
tahtana, nganggo anggean karung, tuluy diuk dina
lebu. Mantenna marentahkeun
ka sarerea baralik tina
jalan-jalanna anu jahat
jeung telenges, sarta
neneda supaya ALLAH
ngahampura maranehna.

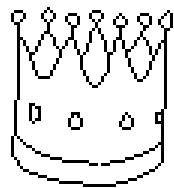

Allah LERES ngahampura maranehna! Harita teh tangtu matak jadi poé anu éndah di Ninewe kulantaran jalma-jalma sadar yén Allah geus ngahampura maranéhna. ...

Tapi aya saurang anu ambek pisan. Yunus!



Naha Yunus ambek? Anjeunna ngadawuh ka Allah, "Kuring terang yen Anjeun teh Allah asih, jeung welas asih, henteu gancang ambek, sarta hébat dina sagala rupa kahadean." Kukituna, Yunus terang yén Allah salawasna ngahampura jalma anu tobat tina dosana sareng nurut kana Firman Allah. Sigana Yunus teu resep ka urang Ninewe. Anjeunna mah teu iklas mun aranjeunna dihampura.



Nabi Yunus kacida benduna ka Allah, tuluy ngalahir, "Cabut we nyawa abdi, sabab maot langkung sae kanggo abdi ti batan hirup."



Yunus calik di luar kota, ngarep-ngarep naon nu bakal dilampahkeun ku Gusti. Gusti Allah nyayogikeun pepelakan anu daunna ageung. Eta tumuwuh gancang, sarta ngiuhan Yunus tina panonpoé.



Isukna, Allah ngirim hiji cacing, anu maehan
pepelakan eta. Tuluy, Allah ngayakeun angin
panas jeung kuat nu neunggeulan Yunus nepi
ka karasana bakal maot. Ieu sadayana pok
matak Yunus langkung ambek.



Lajeng ALLAH ngandika ka Yunus,
"Naha maneh boga hak kitu keur
ambek? Anjeun karunya ka tangkal
anggur nu teu dipelak jeung
dipiara ku anjeun.

Eta tangkal
teh mucunghul
sapeuting jeung
paeh sapeuting.



Naha Kami teu karunya
ka Ninewe, eta kota gede,
jeung rebuan pangeusina?"



Yunus jeung Lauk Gede

Carita tina Dawuhan Gusti, Alkitab

Kenging ti

Yunus

"Ngawitan bubukana Dawuhan Gusti anu
masihan Caang." Psalm 119:130



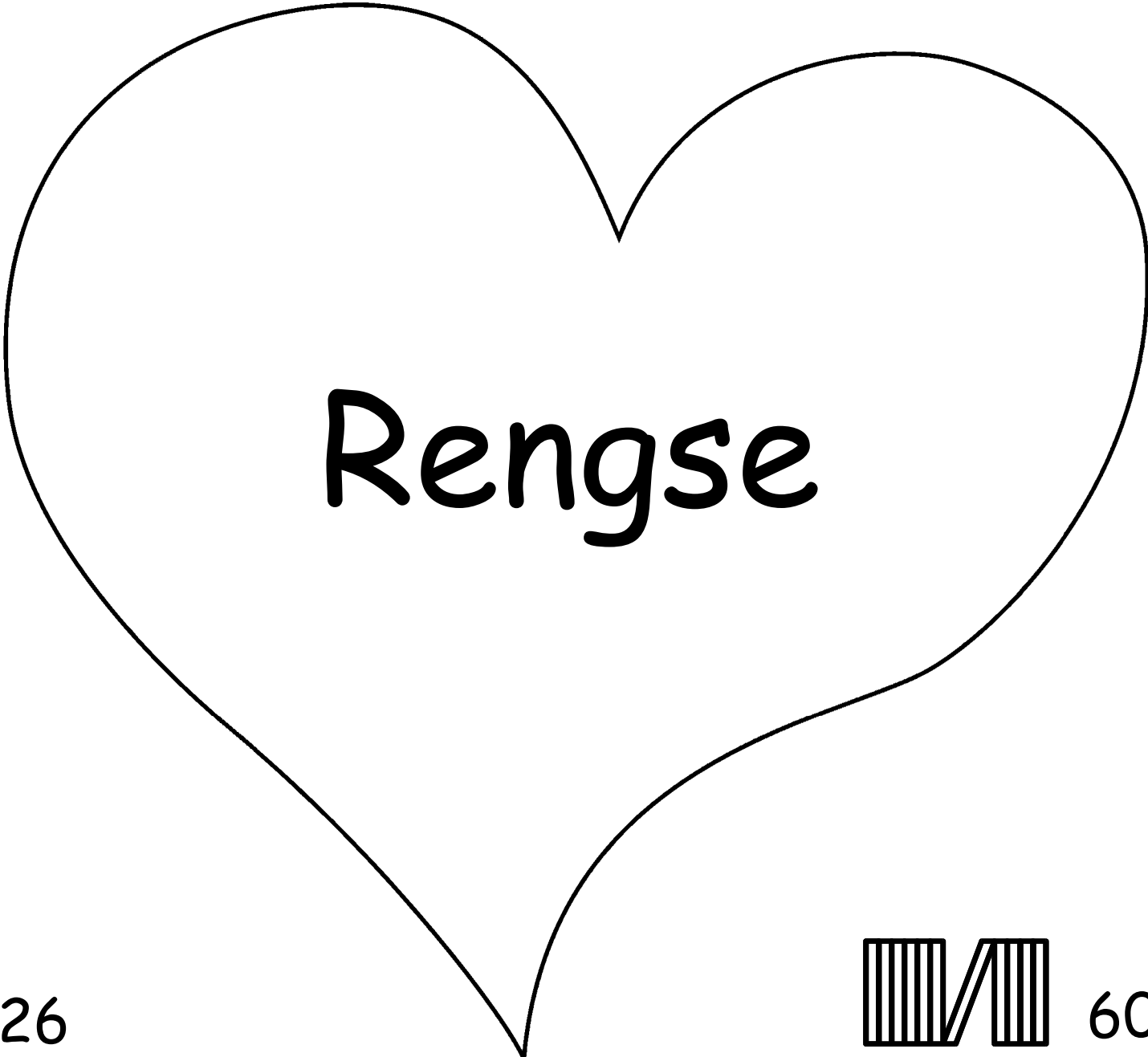

Rengse

26

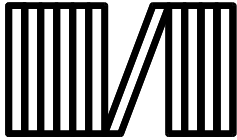

60



Kisah Kitab Suci/Alkitab ieu nyarioskeun kasaean Gusti anu tos ngajantenkeun urang, sareng anu mikahoyong sangkan urang tiasa wanoh ka Anjeuna.

Gusti uningaen yen urang teh tos seueur milampah kasalahan, anu ku Mantena disebut dosa. Hukuman akibat tina dosa teh nyaeta pati, tapi Gusti Allah kacida mikanyaah Saderek dugika ngutus Putrana Yesus, kanggo pupus dina kai palang teras dihukum kumargi sagala dosa Saderek. Teras Yesus gugah deui sareng diangkat ka sawarga! Upami Saderek percanten ka Yesus tur neneda ka Anjeuna supados ngahampura sagala dosa Saderek, Anjeuna baris ngalaksanakeun panuhun Saderek eta! Anjeuna bakal sumping sareng linggih di lebet Saderek ayeuna keneh oge, tur Saderek bakal sasarengan sareng Anjeuna salalamina.

Upami Saderek percanten yen ieu sadaya teh hiji bebeneran, saurkeun ka Gusti sapertos kieu:

Nun Yesus, abdi percanten yen Anjeun teh Gusti, anu mijalma janten manusa tur pupus kanggo sagala dosa abdi, ayeuna Anjeun hirup deui. Sumangga sumping dina kahirupan sim abdi, hapunten sagala dosa abdi, supados abdi tiasa ngengingkeun hirup anu anyar, tur engke dina hiji waktos bakal sasarengan sareng Anjeun salalamina. Tuyun sim abdi supados taat mung ka Anjeun, teras abdi tiasa hirup kanggo Anjeun, salaku Putra Gusti, Amin.

Aos Kitab Suci sareng teras cumarios ka Gusti unggal dinten! Yohanes 3:16

