

Bibilia ya watoto Inaleta



Mbinguni,
nyumbani
pazuri kwa
mungu



Kimeandikwa na: Edward Hughes

Kimeorodheshwa na: Lazarus
Alastair Paterson

Imerekebishwa na: Sarah S.

Kimetafsiriwa na: Grace Chepkoech

Kimedhibitishwa na: Bible for Children
www.M1914.org

©2020 Bible for Children, Inc.

License: Kuna ruhusa ya kuchapa hadithi hii, lakini bila ya kuuza.



Yesu alipokuwa akiishi duniani aliwaeleza wanafunzi wake kuhusu mbinguni. Alipaita "Nyumbani mwa Baba Yangu", na akasema kuwa kule kuna makao mengi ya kupendeza. Mbinguni ni kubwa na kupendeza kuliko nyumba yoyote hapa duniani.

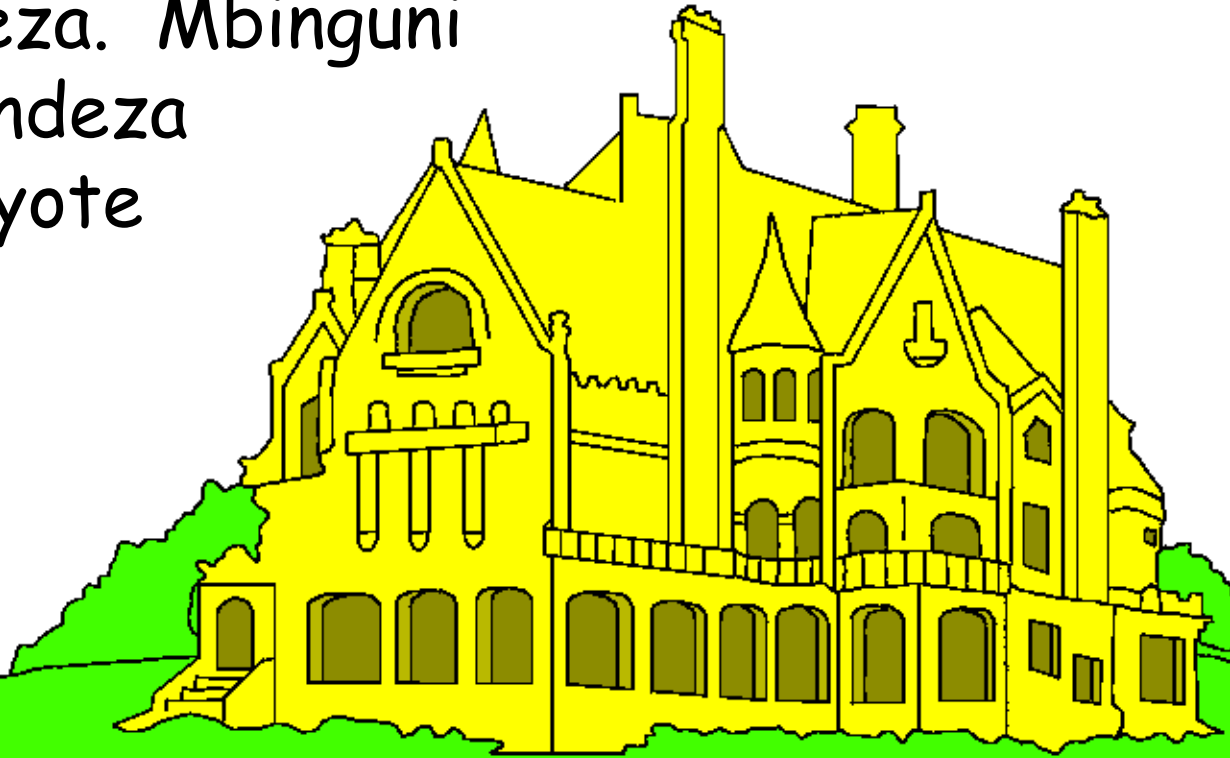

Yesu akasema, "Ninaenda kuwaandalia mahali. Basi mimi nikienda kuwaandalia mahali, nitakuja tena niwakaribishe kwangu." Yesu alienda mbinguni baada ya kufufuka kifoni. Wanafunzi wake wakitazama, Yesu alichukuliwa juu, na wingu likamchukua ili wasimwone tena.

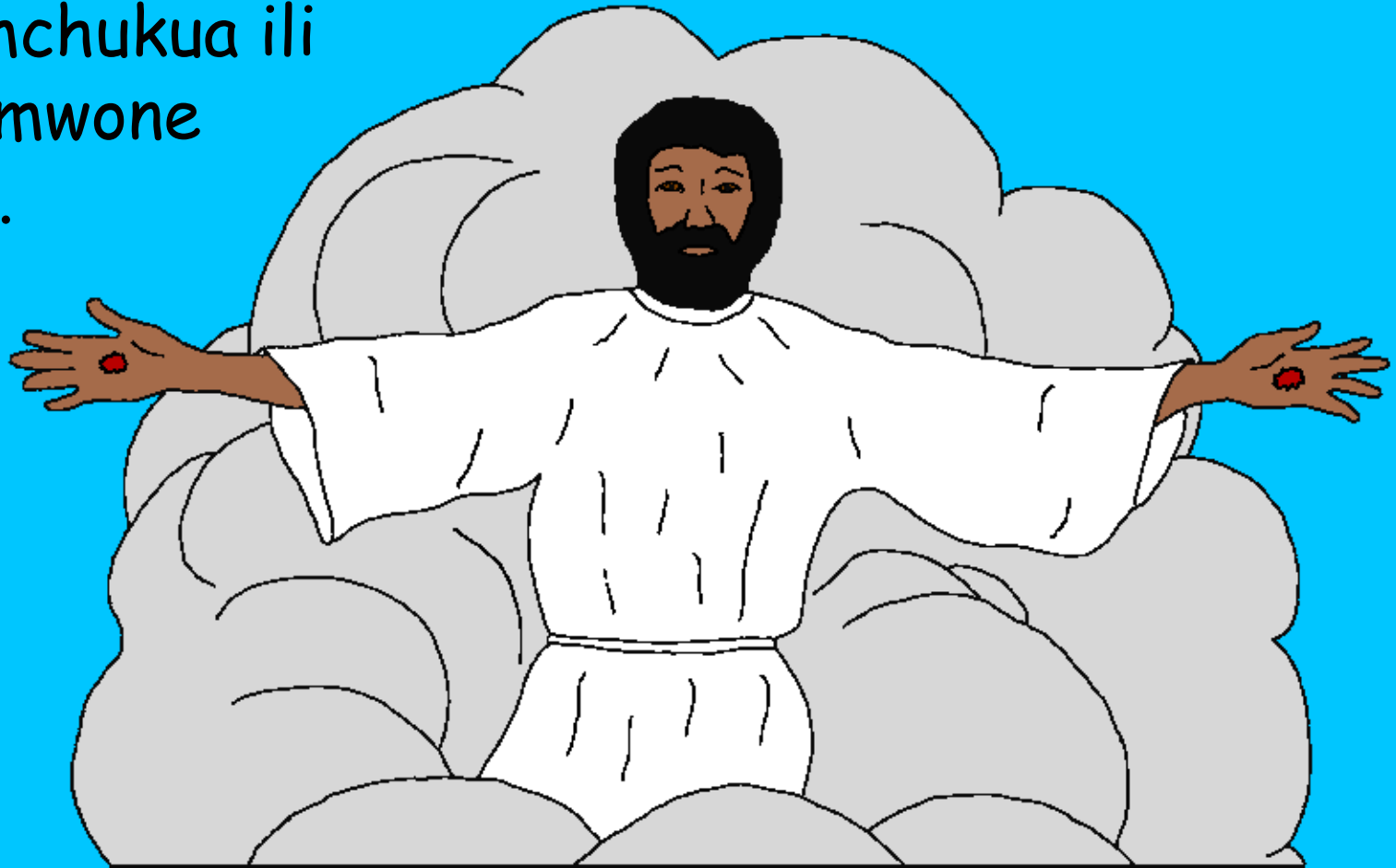

Tangu hapo, wakristo hukumbuka ahadi ya Yesu kuwa atarudi kuwachukua. Yesu alisema kuwa atarudi ghafla, wakati ambao hawamtarajii.

Lakini, je wakristo watakaokufa kabla hajaja? Biblia inasema wataenda moja kwa moja kuwa na Yesu. Kutokuwa kwa mwili ni kuwa na Yesu.



Ufunuo, kitabu cha mwisho cha bibilia, inatueleza jinsi mbinguni ni ya ajabu. Kitu cha kushangaza ni kuwa, katika njia ya kipekee, mbinguni ni nyumbani mwa Mungu. Mungu yupo kila mahali lakini enzini kwake ni mbinguni.

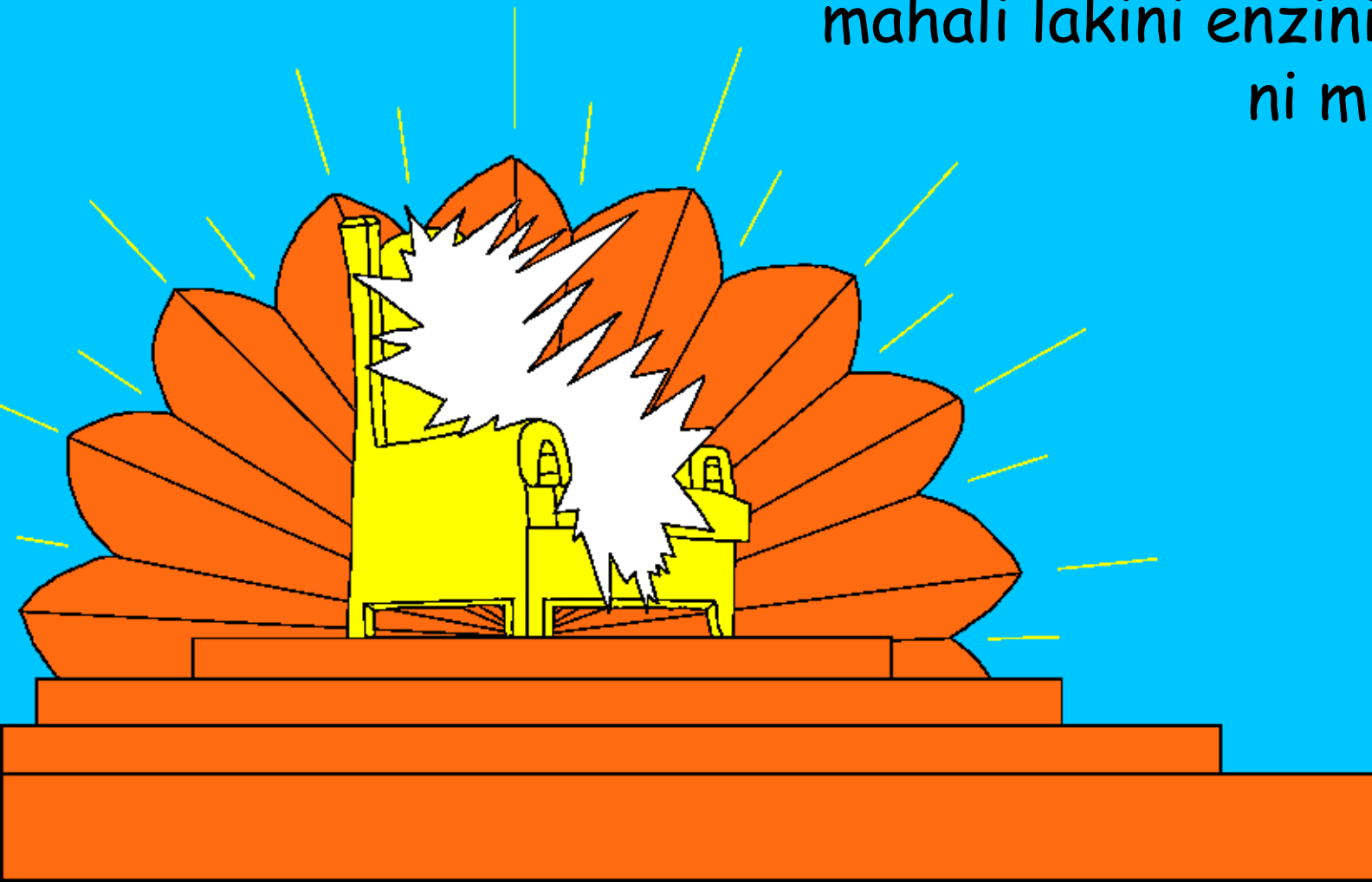

Malaika na viumbe vingine mbinguni
wanamwuabudu Mungu mbinguni.
Pia watu wote wa Mungu
waliokufa na kuenda mbinguni
wanamwuabudu. Wanaimba
nyimbo za sifa kwa Mungu.

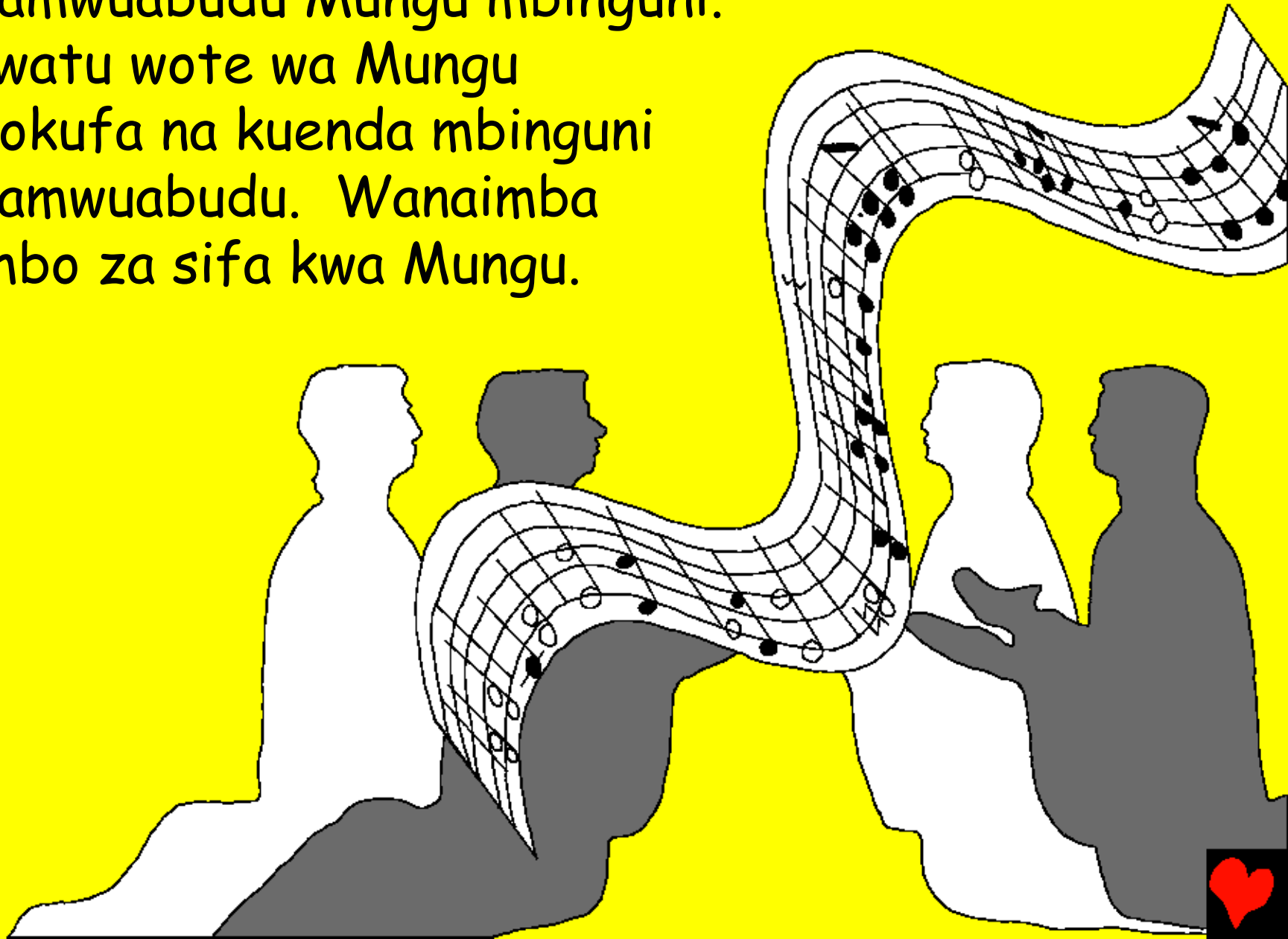

Haya ni maneno kutoka wimbo moja wao huimba:
WEWE UNASTAHILI KWA KUWA
WEWE UMETUREJESHA KWA
MUNGU KUPITIA DAMU YAKO
KWA KILA KABILA NA TAIFA
NA UMETUTENGENEZA
WAFALME NA
MAKUHANI
KWA MUNGU
WETU.
(Ufunuo 5:9)



Kurasa za mwisho katika bibilia zinaelezea mbinguni kama "Yerusalemu Mpya". Ni kubwa ajabu, ikiwa na kuta za juu nje. Kuta zimeundwa kwa yaspi, mfano wa kioo safi. Vito vya ajabu vimepamba kuta, ziking'aa na rangi za kupendeza.

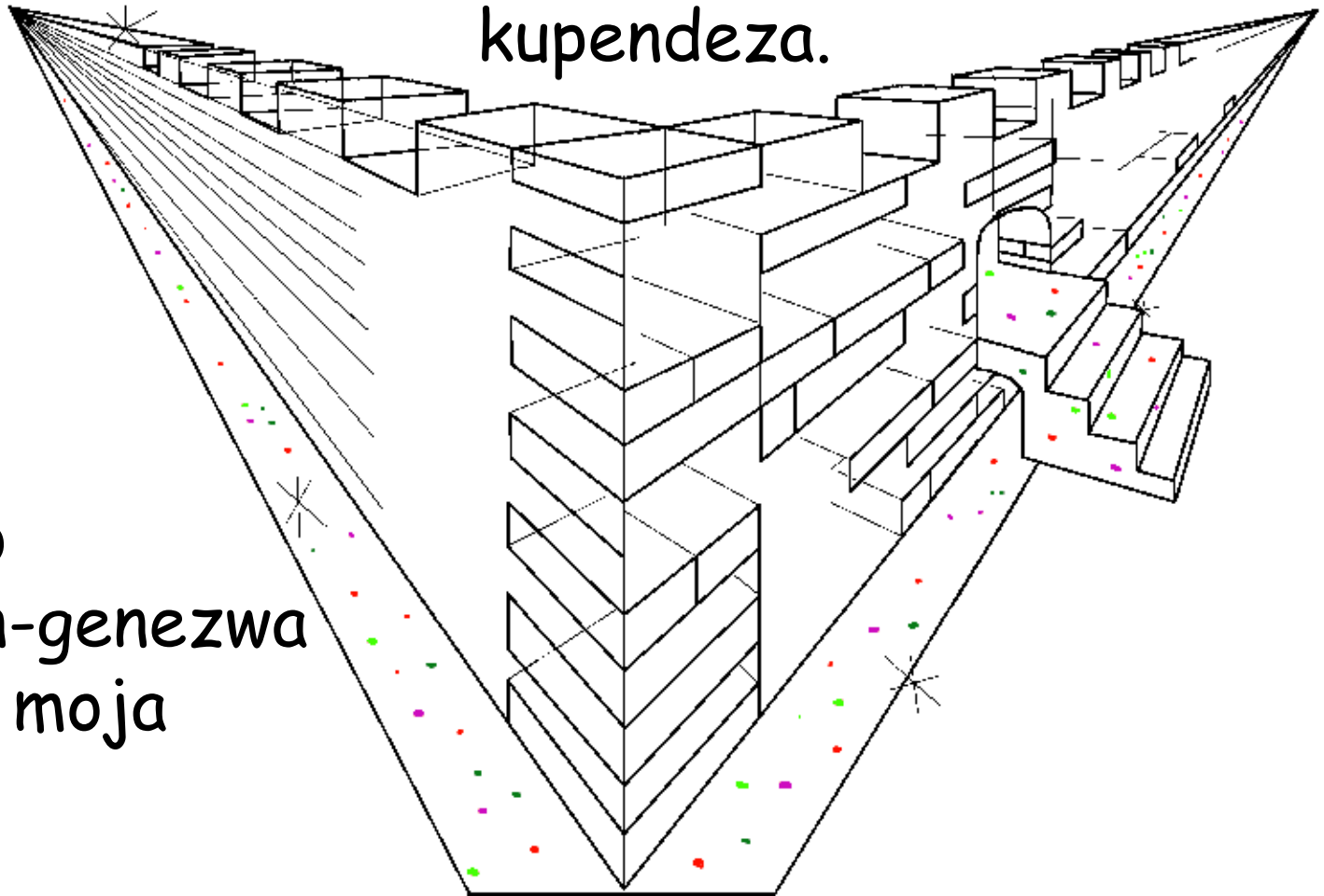

Kila mlango imeten-genezwa na lulu moja kubwa!



Hiyo milango ya lulu huwa wazi kila wakati. Tuingie ndani tukaone zaidi... WAAA! Mbinguni ni ya kupendeza hata zaidi ndani. Mji ule ni wa dhahabu safi, kama kioo kiangavu. Hata njia ni ya dhahabu.

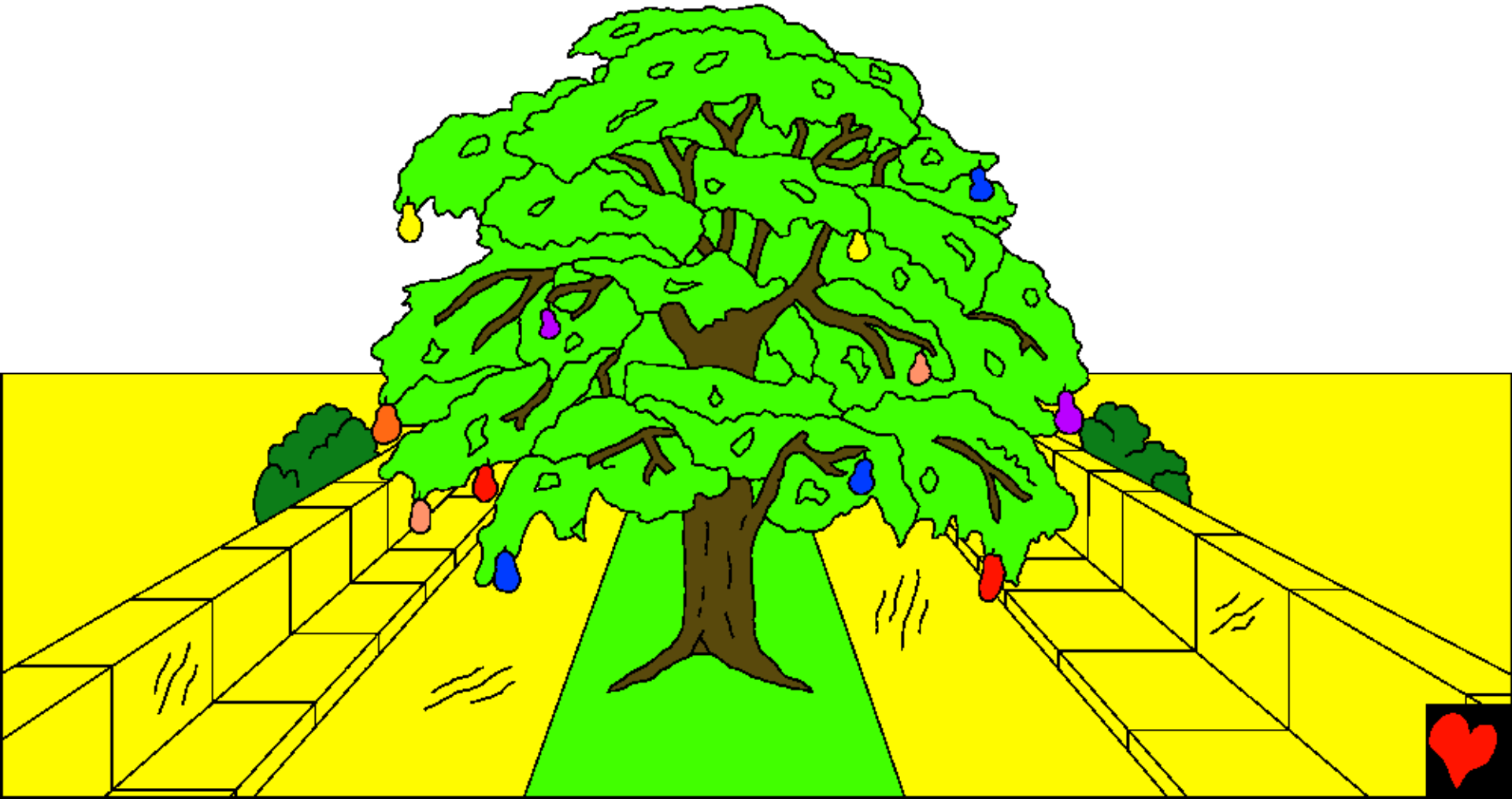

Mto wa maji safi ya uzima, wenye kung'aa unatirirka ukitoka katika kiti cha enzi cha Mungu. Upande huu na upande ule wa mto kuna mti wa uzima, ambao ulipatikana kwanza katika bustani ya Edeni. Mti huu ulikuwa wa kipekee. Ulikuwa unazaa matunda aina kumi na mbili, wenye kutoa matunda aina tofauti kila mwezi. Na majani ya mti huo ni wa kuponya mataifa.

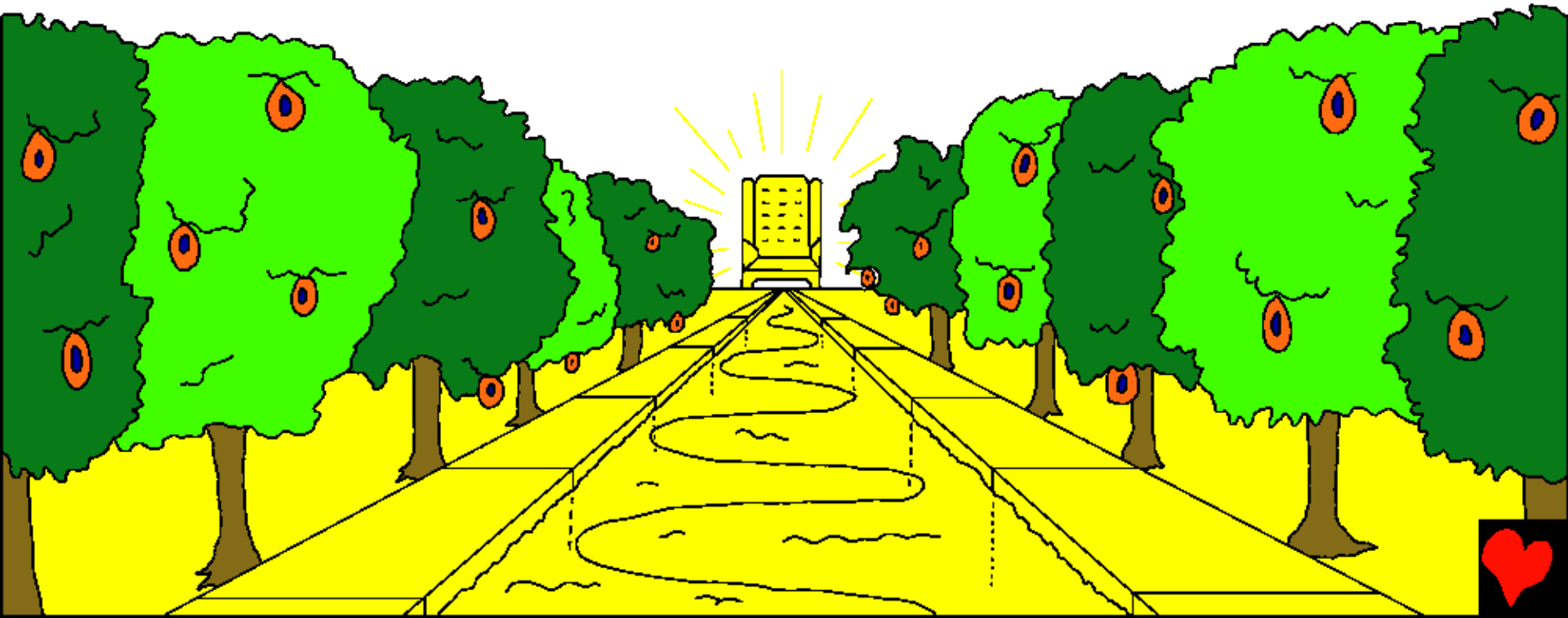

Mbinguni haiitaji jua wala mwezi kuangaza. Utukufu wa Mungu hutia nuru ya ajabu. Hakuna usiku kule hata kamwe.

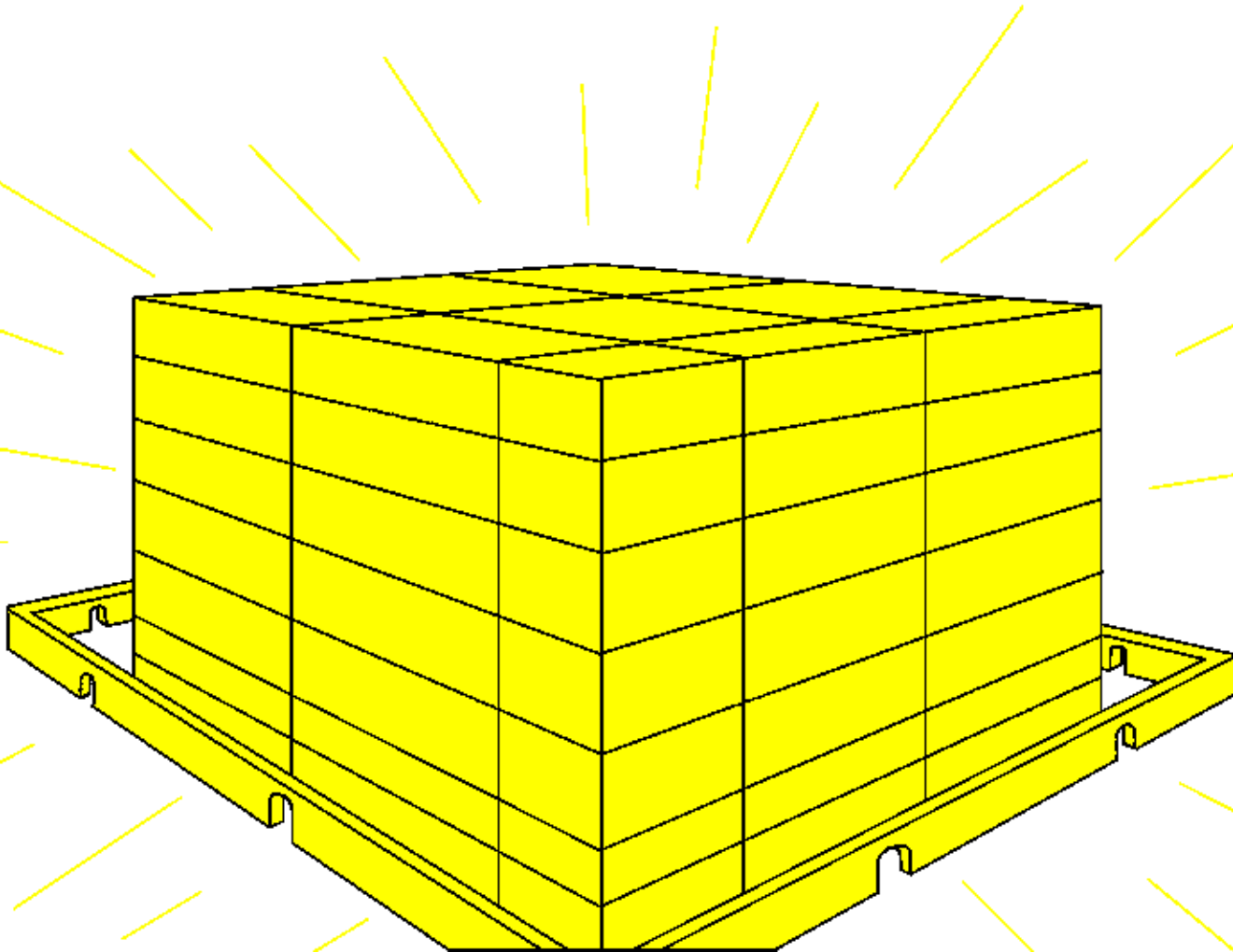

Hata wanyama mbinguni ni wa aina tofauti. Wote ni watulivu na wenye urafiki. Mbwa mwitu na mwana kondoo wanakula nyasi pamoja. Hata simba wanakula nyasi kama ng'ombe. Bwana anasema, "Hawataumia wala kuangamia katika mlima wangu mtakatifu."

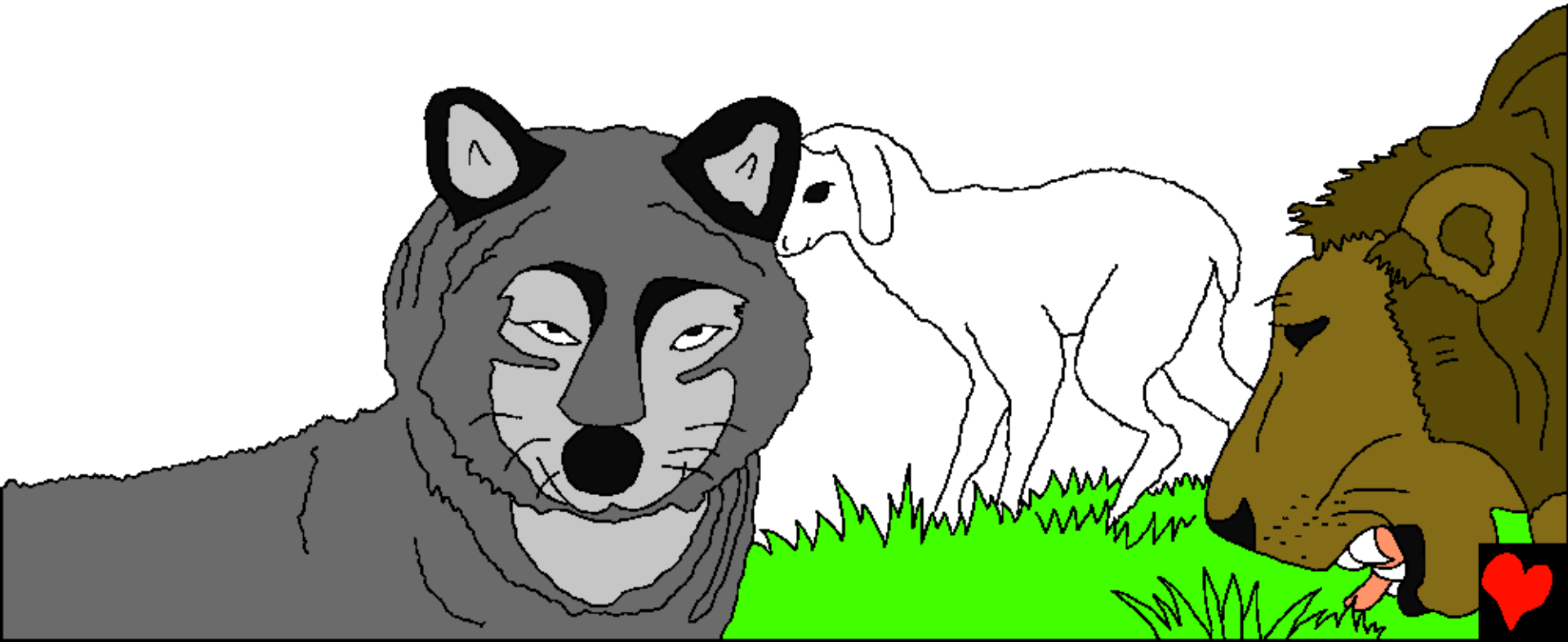

Tunapozidi
kutazama,
tunagundua
kuwa kuna vitu
vinavyokosa
mbinguni.
Hakuna
maneno
ya hasira.
Hakuna
mtu
anayepigana
au kunyima.

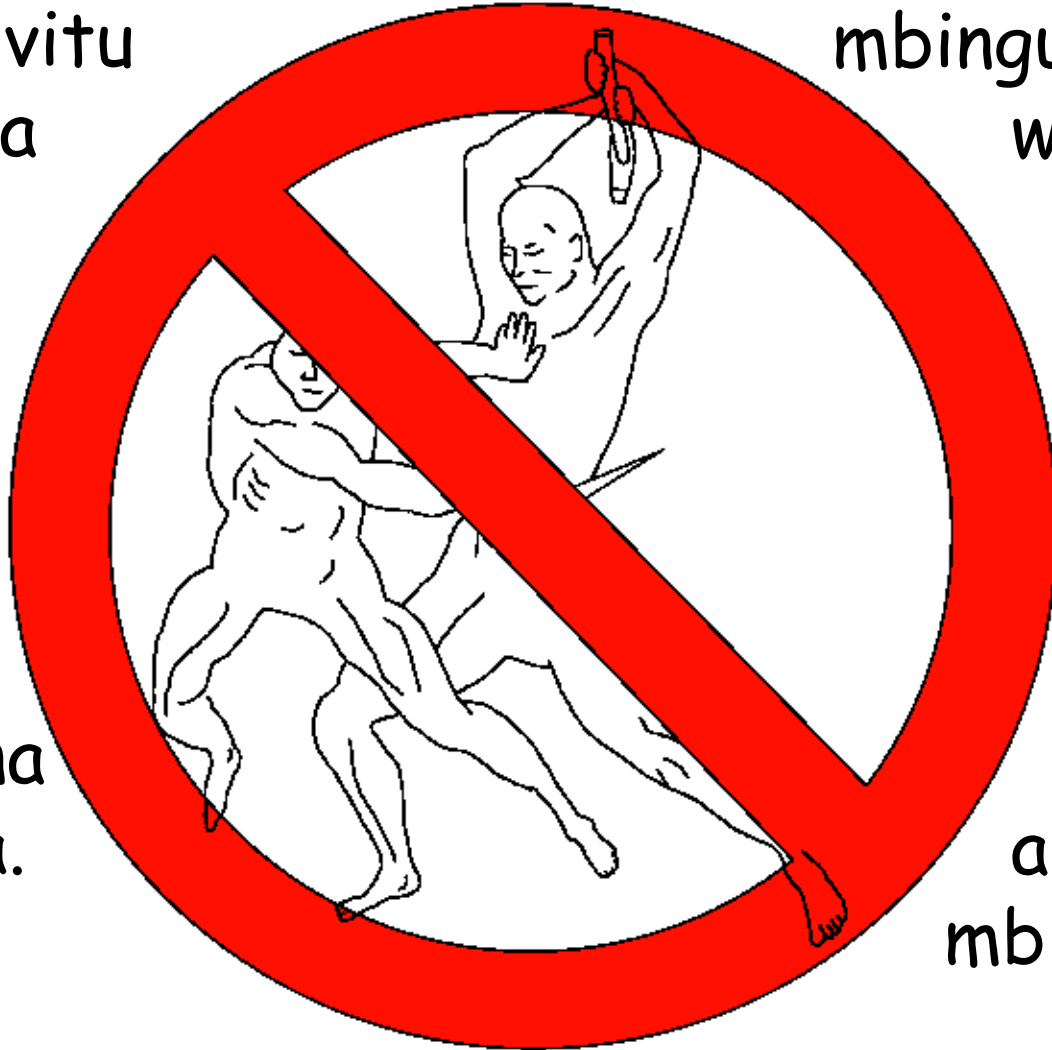

Hakuna vifunguo
mlangoni kwa kuwa
hakuna wezi
mbinguni. Hakuna
waongo,
wauaji,
wachawi
au watu
wengine
waovu.
Hakuna
dhambi ya
aina yoyote
mbinguni.



Mbinguni kwa Mungu
hakuna kilio tena. Wakati
mwingine watu wa Mungu
hulia kwasababu ya
mateso makuu ya maisha
haya. Mbinguni, Mungu
atapanguza machozi yote.



Hakuna kifo mbinguni pia. Watu wa Mungu watakaa milele na Bwana. Hakutakuwa na mateso, kilio, uchungu tena. Hakutakuwa na magonjwa, kuachana, matanga tena.

Kila mtu ataishi kwa furaha na mungu.

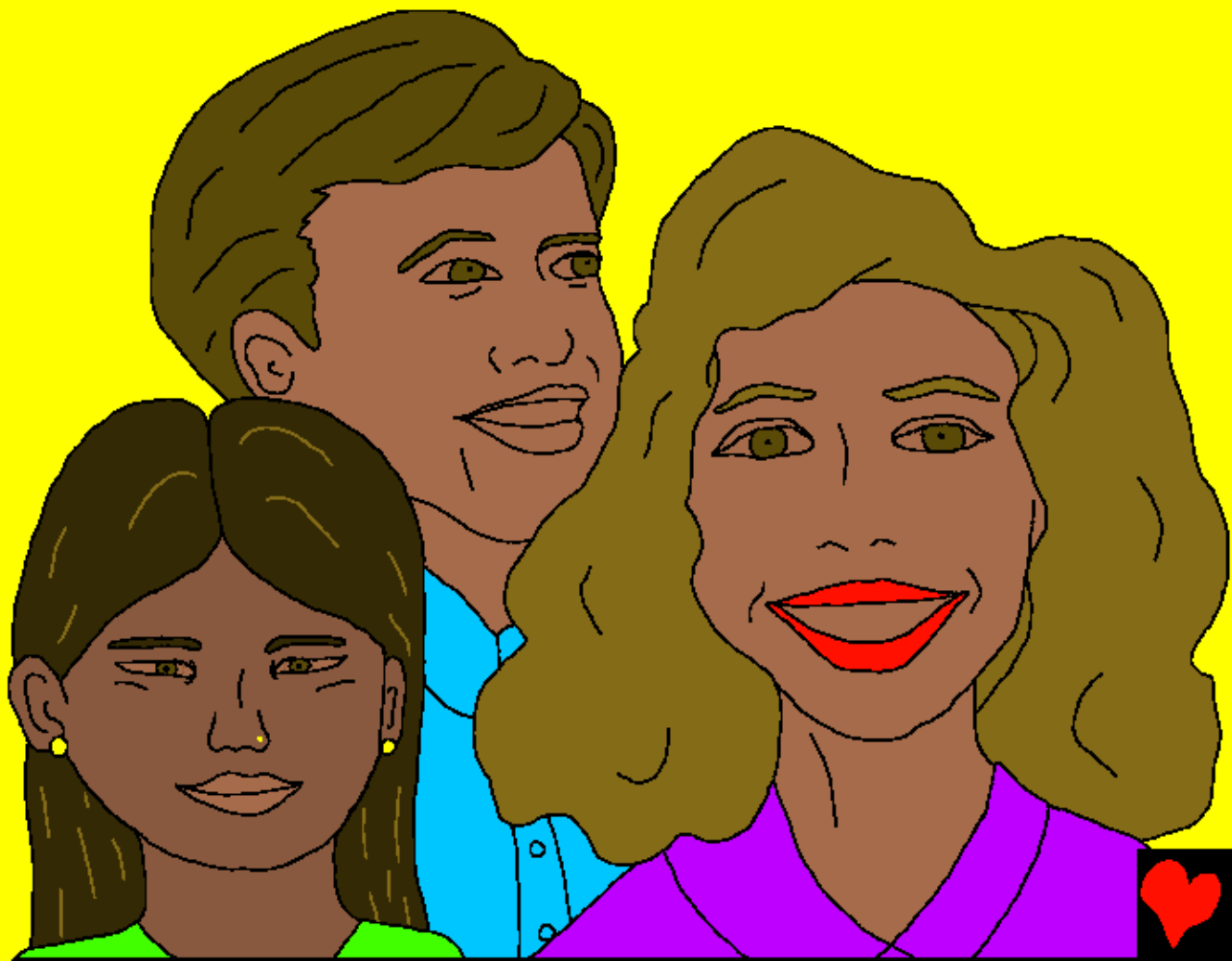

Kupendeza zaidi, mbinguni ni ya wasichana na wavulana (na watu wazima pia) ambao wamemwamini Yesu Kristo kama mwokozi na kumtii kama Bwana wao.

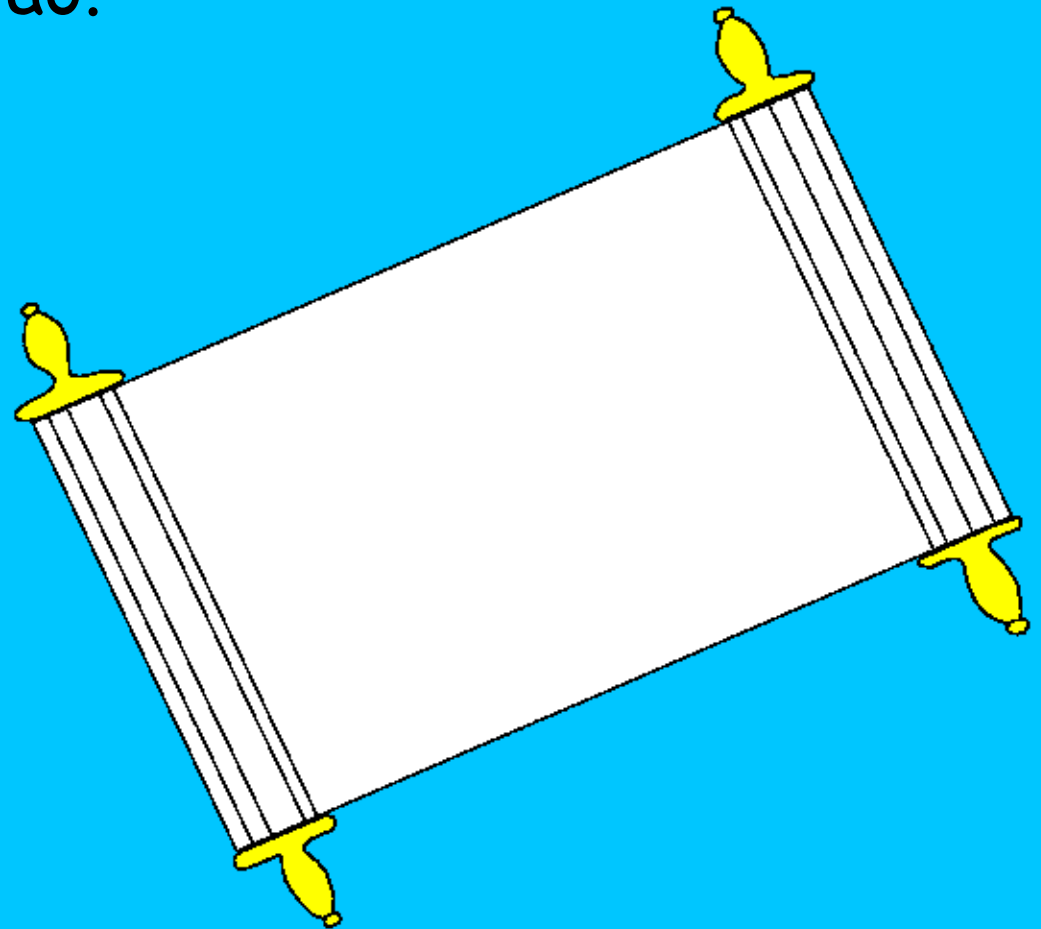

Mbinguni kuna kitabu kiitwacho
Kitabu cha Mwana kondoo cha
Uzima. Kimejaa majina ya watu.
Je, wajua ni majina ya nani yaliyo
andikwa? Ni watu ambao
wameweka tumaini yao kwa Yesu.
Je, jina lako limo ndani?

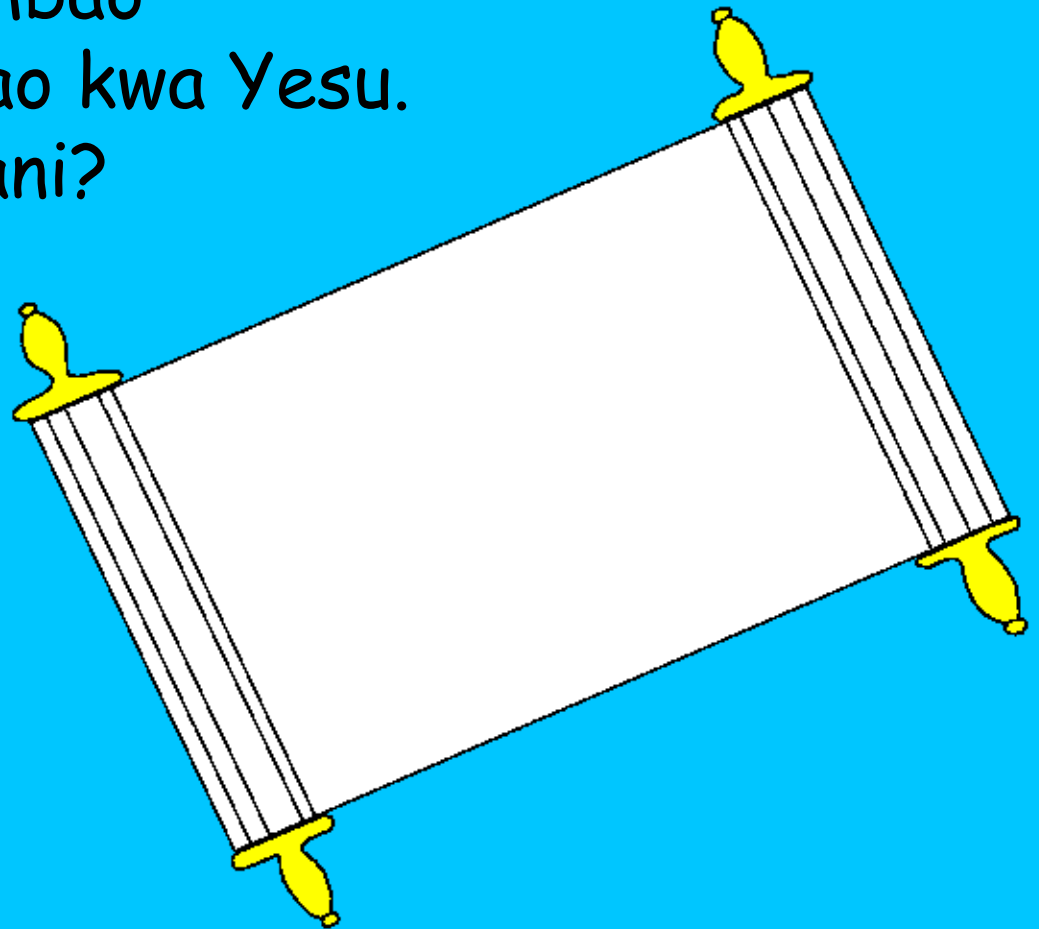

Maneno ya mwisho ya bibilia ina ukaribisho wa ajabu.
"Na Roho na Bibi-arusi wasema, 'njoo!' Naye mwenye
kiu aje. Na yeye atakaye, na ayatwae maji ya
uzima bure."

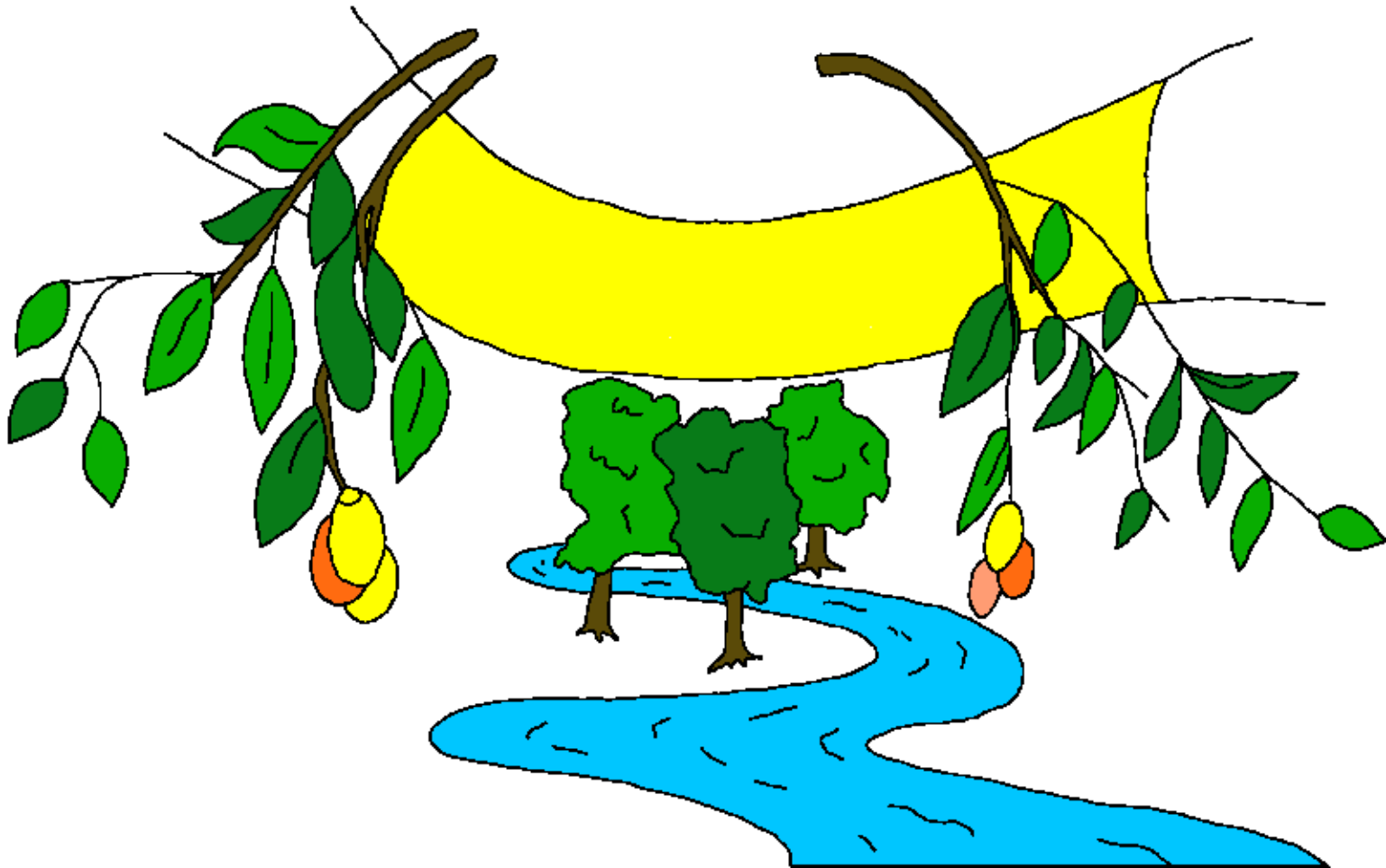

Mbinguni, nyumbani pazuri kwa mungu

Hadithi kutoka kwa Neno la Mungu, Bibilia,

inapatikana katika

Yohana 14, Wakorintho a pili 5, Ufunuo 4,
Ufunuo 21-22

"Kufafanusha maneno yako kwatia nuru."

Zaburi 119:130



Mwisho



Hii hadithi ya bibilia inatueleza kumhusu Mungu wetu wa ajabu aliyetuumba na anayetaka tumjue.

Mungu anajua tumetenda mambo mabaya, anayoyaita dhambi. Adhabu ya dhambi ni mauti, lakini Mungu anakupenda sana hata akamtuma mwana wake wa pekee, Yesu, Ili afe msalabani na aadhibiwe kwa dhambi yako. Alafu Yesu akafufuka na kuenda nyumbani mbinguni! Ukimwamini Yesu na kumwomba msamaha kwa dhambi yako, Atakusamehe! Yesu atkuja na kuishi ndani yako, na utaishi naye milele.

Kama unaamini huu ni ukweli, Sema haya kwa Mungu: Mpendwa Yesu, ninaamini kuwa wewe ni Mungu, na ulifanyika mtu ili ufe kwa ajili ya dhambi zangu, ili niwe na maisha mapya, na siku moja nitaenda kuwa nawe millele. Nisaidie nikutii na niishi kwa ajili yako kama mtoto wako. Amina.

Soma bibilia na uzungumze na Mungu kila siku! Yohana 3:16

