

www.BibleForChildren.org



Juan 14



Dai Suxi ititidai go mamaatirdamigadi, —Gin aaduni,
maiti abir buami gin irhiada tomarhi imo ixtumaxikidi, ka
kiiiga buaboitudai aapimi Diuxi di. Dai aani abir kiiiga gin
buaboitudada ipi. Aidi gia mai buami gin irhiadamu
aapimi tomarhi imo ixtumaxikidi. Daiñi, amika gin Oga
kiidiri muidu tutukabi

dai aani miika
bhai duñimu
xakoga

oidakagi
aapimi.

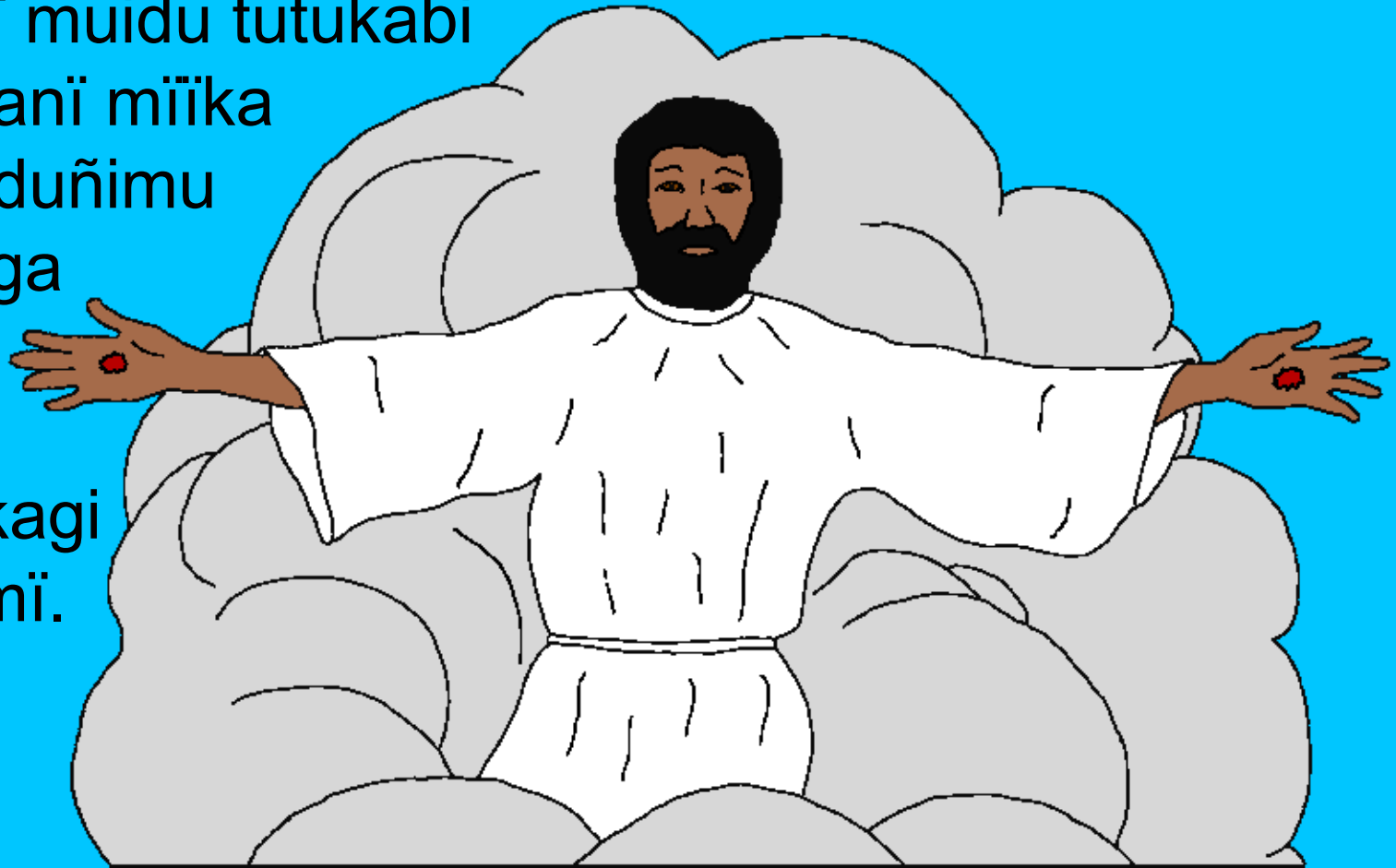

Maiti abir buami gin irhiada tudu. Ix maiti ir
buaboikamudai gobai xadiri gin aagidamudai aanii.
Daini kaxi an gin aagidi sai bhai duñimu aanii xako
oidakana aapimii amika kaxkidi gi maati sai dibiamu
aanii ipamu gokiiri dai gin baidakamu ix amika
oidakana aapimii
gin imadi.

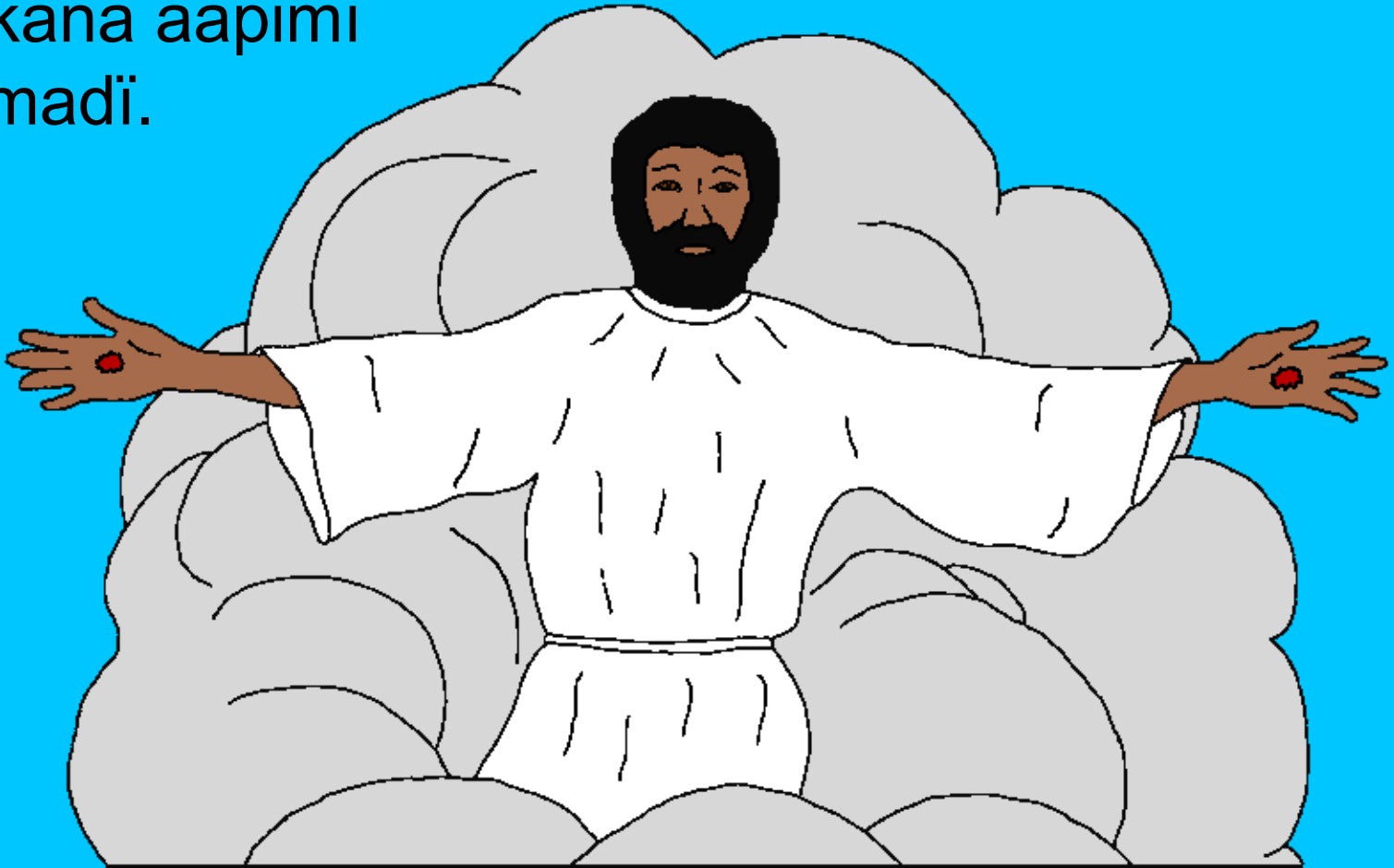

Gin aaduñi, kii maati aani sai soimaaxi gin
taatamiturhiña jaa biina darakatai aapimi Suxi
Kristo dai aani ipi taataiña xi soimaaxi

gin taatamiturhi jaa biina dakatai aani
Suxi Kristo ipi.



İmo xigimi aatimi
tudu soimaaxi gir
taatamiturhitai jaa
aatimi biixkatai.



Dii gia imaduga Gir Nukadakami dai igai ir Suxi
Kristo. Dai biina darakatai aatimi igai buyina
aatimi gubukarhigai ixtukidi gir

kabakadagi go soi irhiaragai
bui. Gin aagidamu aani ix



dukatai gin daibusai
imo imidagai
tumiñoko.



İmo arhi oidigana dajatadai aani aidi ix makidi go
gii sudagi irana kaati. Patmos tigidu go arhi
oidigi igai. Ami gin maixatutadai jaa

aagaitai aani Diuxi ñokidi
dai aagaitai Suxi Kristo.



Ami dajatadai aanī tudu dai imo imidagai gin
tianiitadai Diuxi Ibhīadī dai aanī kīiga iīgidimi bai
todian dukai īgai gubukadadīkīdī kaī aanī

ix gīgiri ño imoko gin
gokiañdīri. Po irhiadan

kaiti
trompeta.



Dai mos potii igai bai gin ayi gubukarhigadi Diuxi
Ibhiadi. Dai Diuxi Ibhiadi gubukarhigadikidi tii aani ix
tibagiiiri kiiika imo gii daikarui dai ami daikaruana daja
Diuxi.

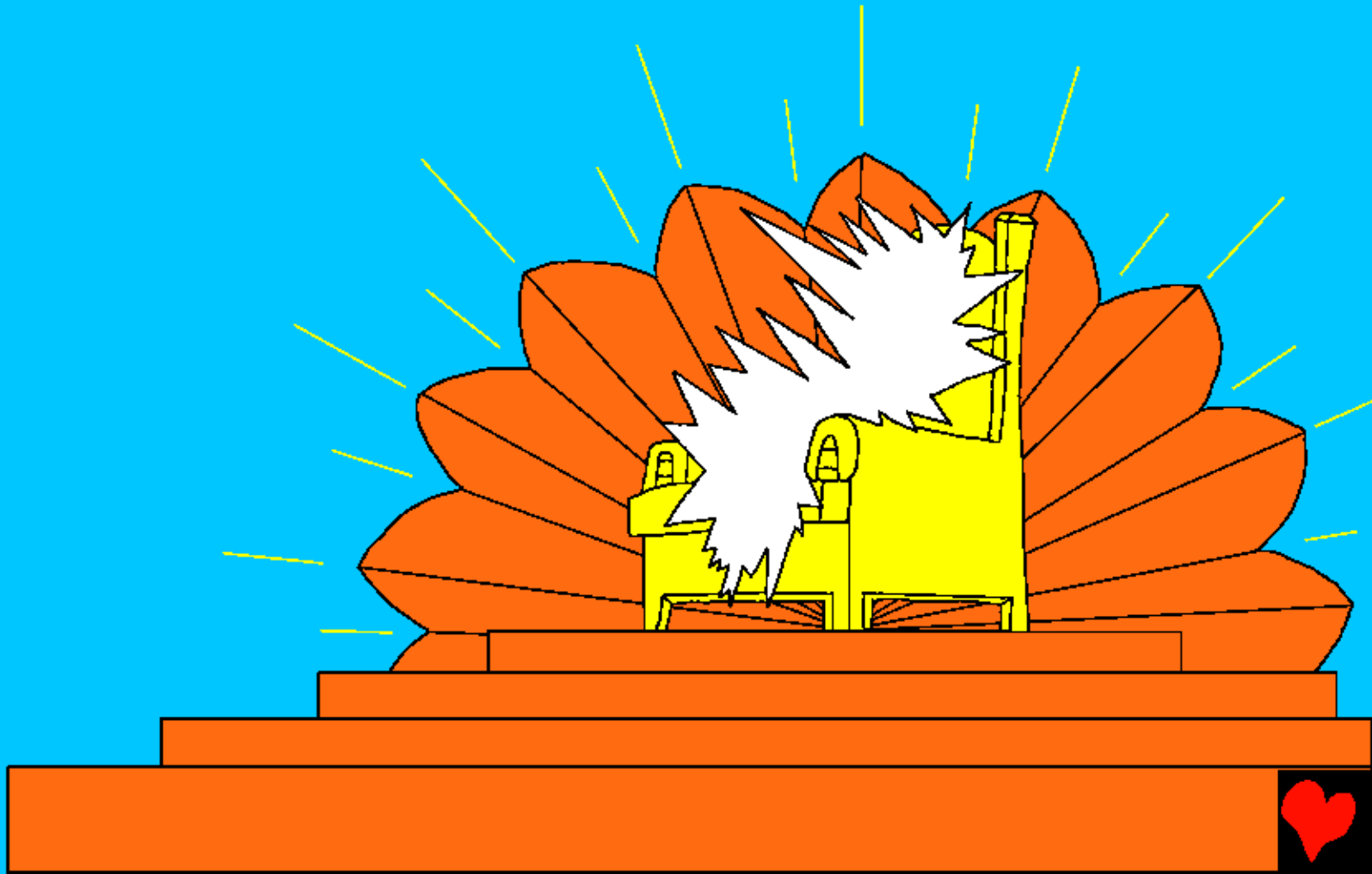

Dai kai aani bixi aikatai ibhikidami ix makidi oidaga
toma xakoga ix nokaitadai ipi. Kai aani ix makidi
tibagiana daraka dai ix makidi
oidigi daama daraja dai oidigi
irana dai go gigiri sudagiiri ipi.



Büxi igai kai aani ix kaitimitadai sai, —Gi agai xi
büxkiri bitari xadutuada aatimi gobai ix makidi go gi
daikaruana daja dai imadi go Arhi
Kañiru tigidukidi. Gi agai xi oigida
nokada aatimi dai aagagi xixi ir
gigirdukami igai. Dai gi agai xi
adaama gatianida
igai büxkiri
bitari—
ikaititadai
büxkatai.



Dai nñidi aanī xi tībagañdīrī tībandimi go gīi kiiki ix makīdī ir Diuxi iko dasadī. Go utudukīdī Jerusalem tīgīdu go gīi kiiki igai dai Diuxiañdīrī tībañimi. Dai kīi xigiamaaxi kīi bhai duñixikatai gobai ipian dukai imo oki xuduku kunata agadagi. Dai gīgīrī ño ixtumaxi mīi go gīi daikaruañdīrī daidi ikaiti,

—Xibi gia odami saagida daja Diuxi kiidī. Xibi odami saagida oidaka agai igai dai kīigakīrī ir Diuxigadīka agai imadī dakatai.

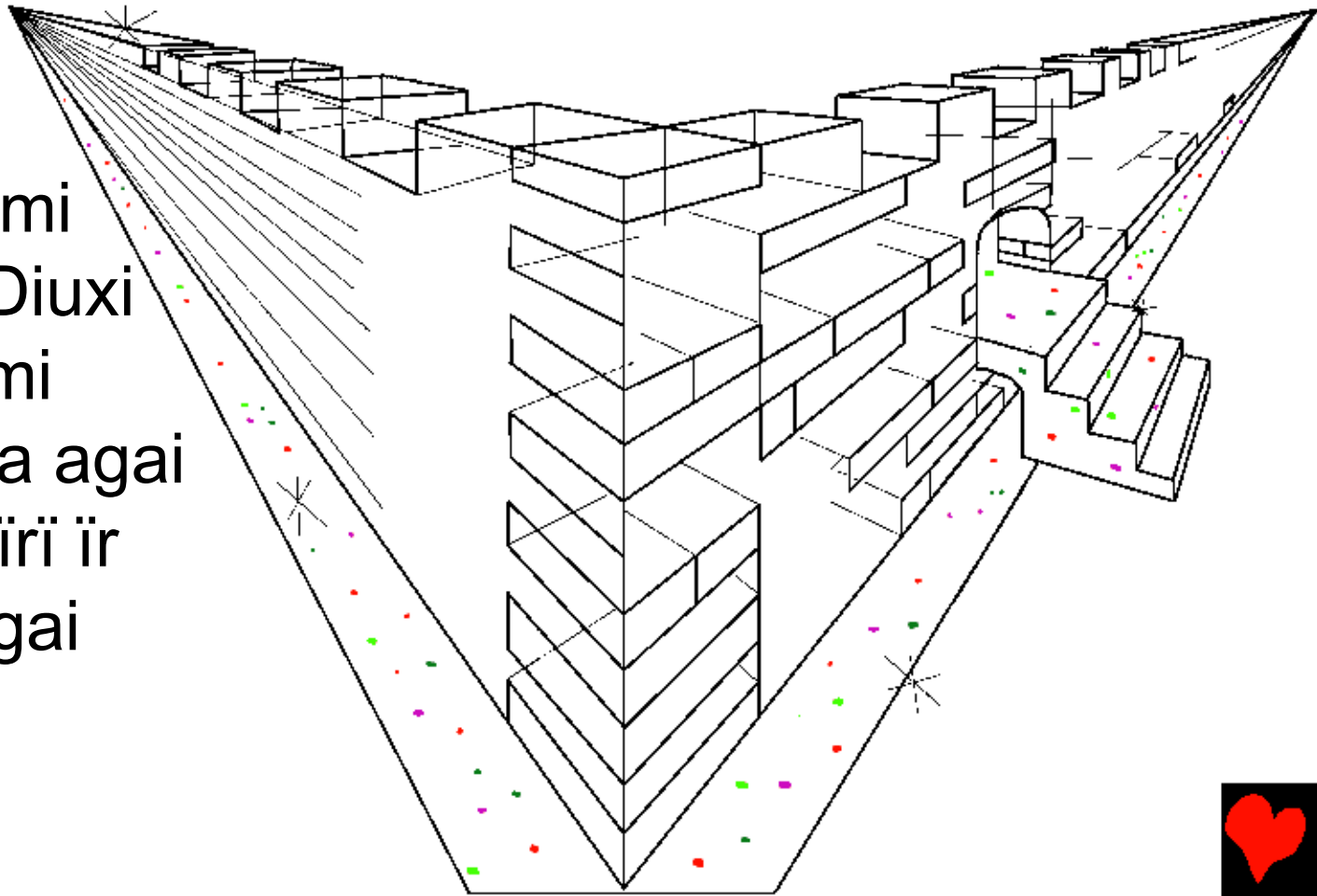

Dai bhodiri go tianikarudi Diuxi gin tigi go aki ami go
gii kiikiiri xako mirai go sudagi ixtukidi kigakiri oidaga
odami. Kii buanixi go sudagi. Ipiamaaxi bidrio kii
buanixikatai. Go gii daikaruandiri mirai gobai xako daja
Diuxi imadi go Arhi Kaniru tigidukidi.

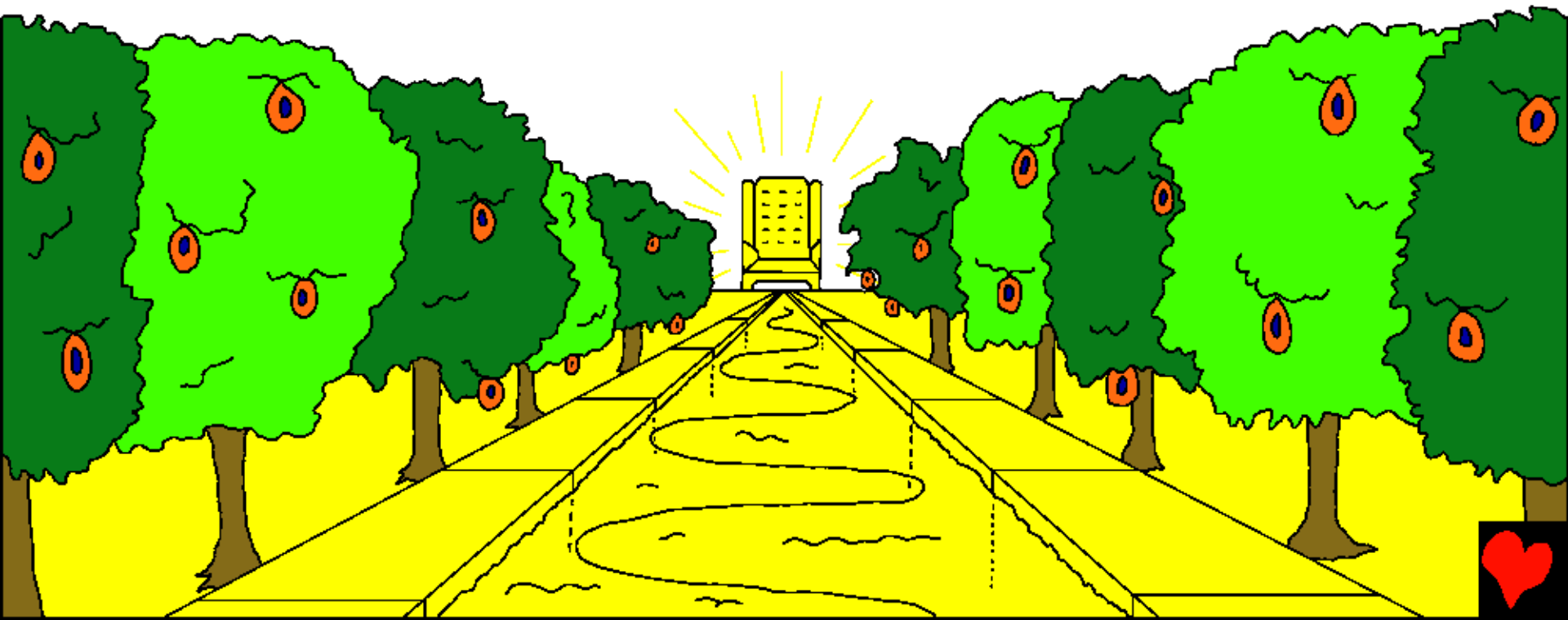

Ami maiti gī agai tasai dai tomarhi masadai. Diuxi igai daidi ir kudagigadi kaxkidi dai go Arhi Kañiru tigidukidi ir kudakarudika agai mos ii kudagigakatai igai bii gokatai.

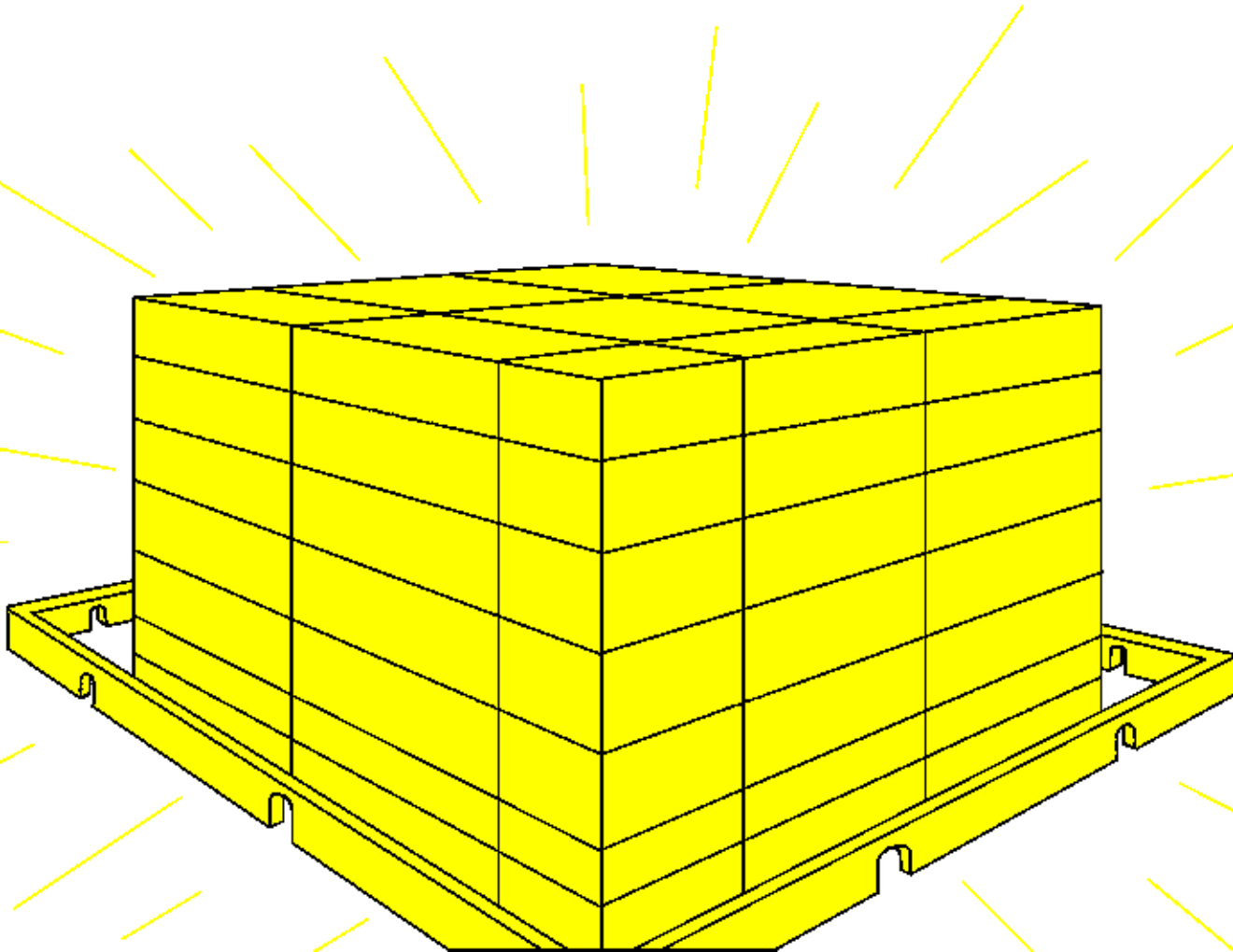

Dii gia mai bakimu ami tomarhi imo ixtumaxi
soimaaxkami dai tomarhi imo odami ix makidi
tukurhimagi ibhiadi soimaaxi
ibuadatai xiipi yaatagiitai.
Igai tomarhi imo imidagai
mai bapakimu ami.
Mosikaxi odami ix
makidi ojixi librogadiri
go Arhi Kañiru
tigidukidi xako ojixi
xorai biixkiri bitari
oidaka agai. Igai gia
bia oigaragai ix
bapakidagi ami.



Xibi Diuxi buana agai bīixi odami
suañibharudī. Xibi ka mai
tipukamu mukigami tomarhi
soigamudagai tomarhi
suanīdagai tomarhi kokodagai.
Bīixi ixtumaxi ikidadī ugiti agai
tudu— ikaiti go ñoki.



Ami go gii kiikiiri mai tipukamu tomarhi imo ixtumaxi ix
makidi bia gigibidaragai abhana. Dai ami kiakamu go
gii daikarui xako darakatai gatiiani Diuxi imadi go Arhi
Kañiru tigidukidi. Dai ami go buaboitudadami
xadutuadamu Diuxi
dai asta niijadamu
buibasodi. Dai Diuxi
titiaragadi ojixikamu
kokobadiri
buaboitudadami.

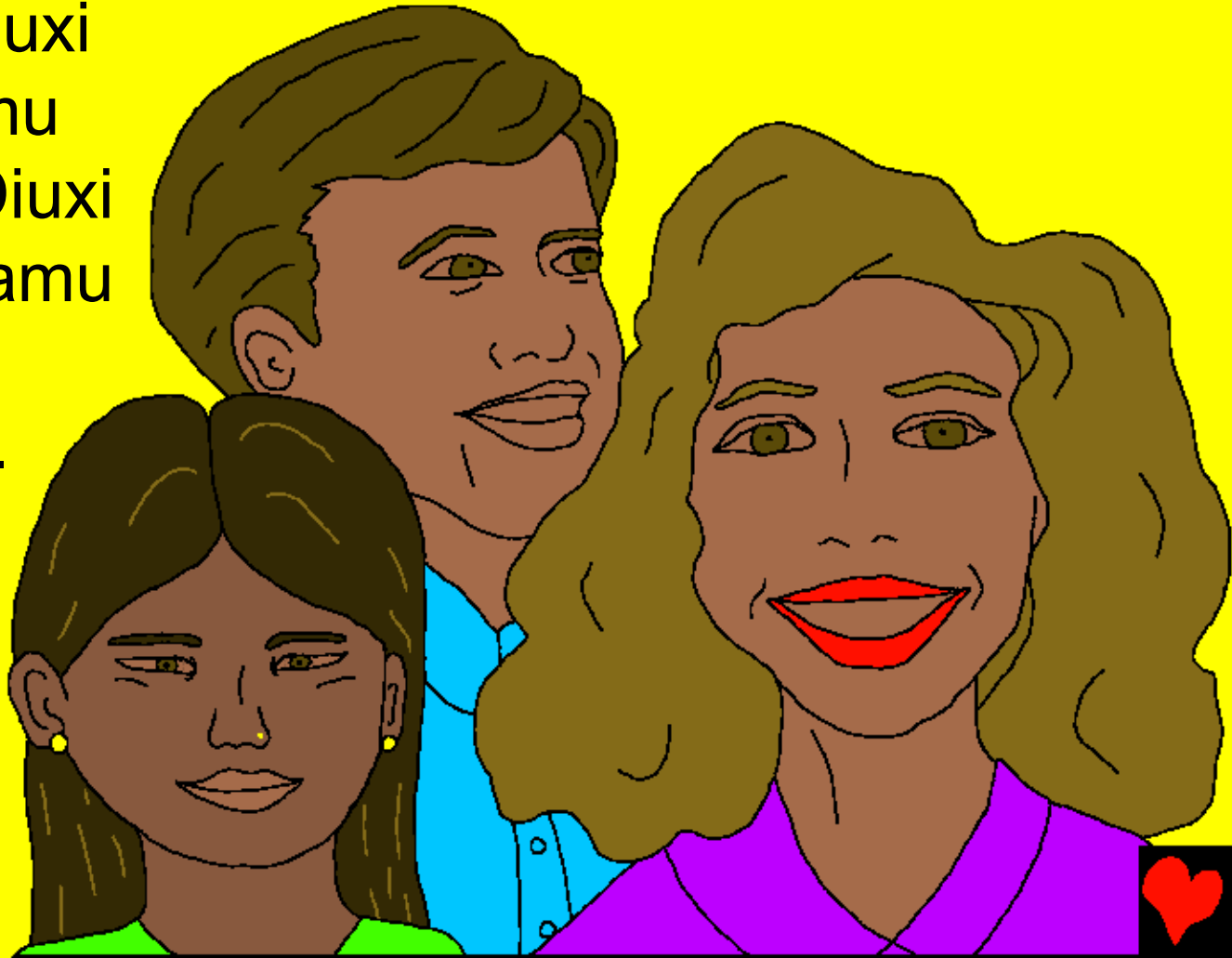

Dai bhodiri niidi aani xi ami go gi daikarui tojakami
buidiri gukatadai biixi koidadi. Ami gukatadai ix makidi ir
gatitianiidamikatadai dai modukai ix makidi mai
gatiianiitadai toma liichi ipi. Biixi koidadi ami gukatadai
tudu. Ami gukatadai asta ix makidi go gi sudagiiri
koitadai imadi biixkatai ix makidi Hadeana
darakatadai xako bipiyyi biixi koidadi.
Ami gukatadai igai go gi daikarui
buidiri. Mitai kupioka
go lilibro xakoga ojixi ix
tuma dui oidakami dai
kupioka igai imai libro ipi
xako ojixi odami ix makidi
kiigakiri ir duduakakami
dai biixkiri biitari oidaka agai.

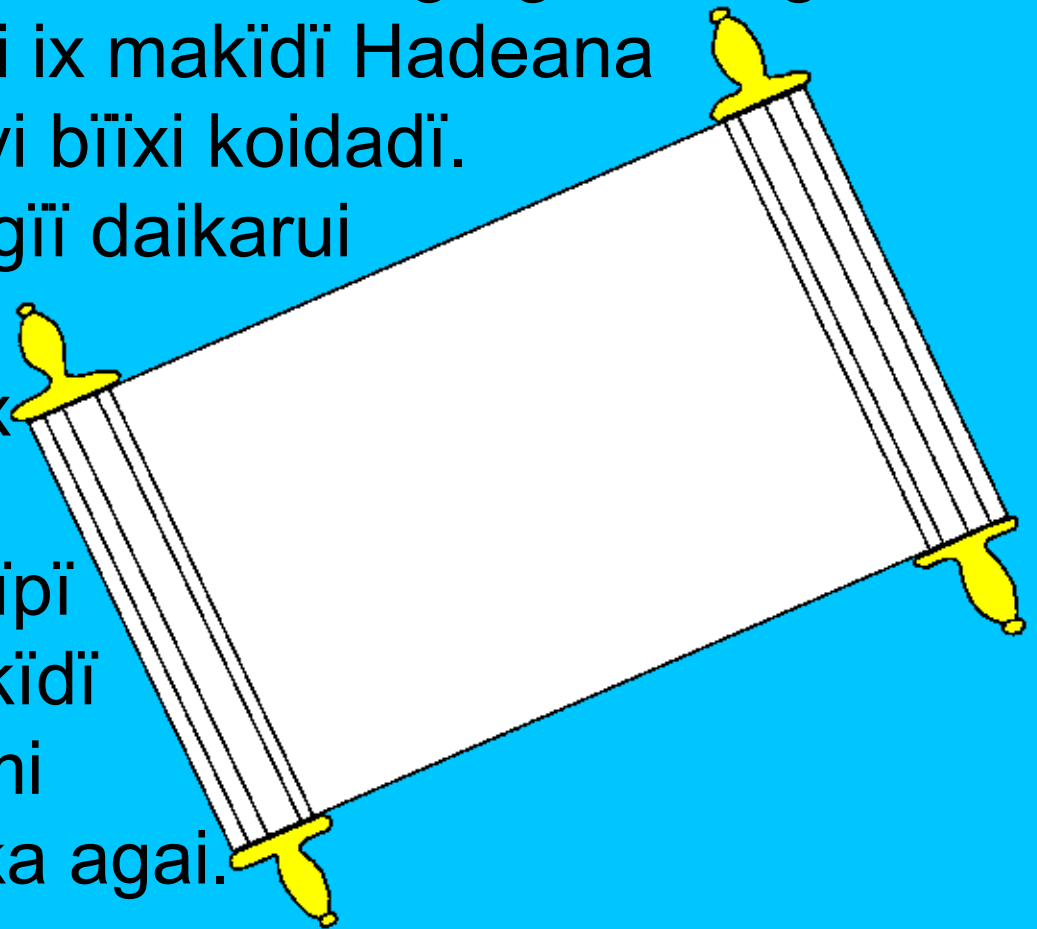

Dai Diuxi aa bīixi go koidadi bīitarī ixtumaxi ajiagai
īimoko nīiditai go lilibroīrī xako ojixi ixtuma dui īgai.
Dai bhodīrī go gīī taiyīrī daitu Diuxi go mukigami
īmadi koidadi kiidī xako darakatadai īgai.
Go koidadi kiidī Hades tīgīdu. Dai bia
Diuxi īmo libro xako ojixi odami ix
makīdī kīīgakīrī īr
duduakakami dai
bīīxkīrī bīītarī óídaka
agai. Dai taiyīrī surhigi
agai īgai bīīxi odami ix
makīdī mai ojixi ami.
Gobai īr go kugatīrī
mukigami agaikīdī.

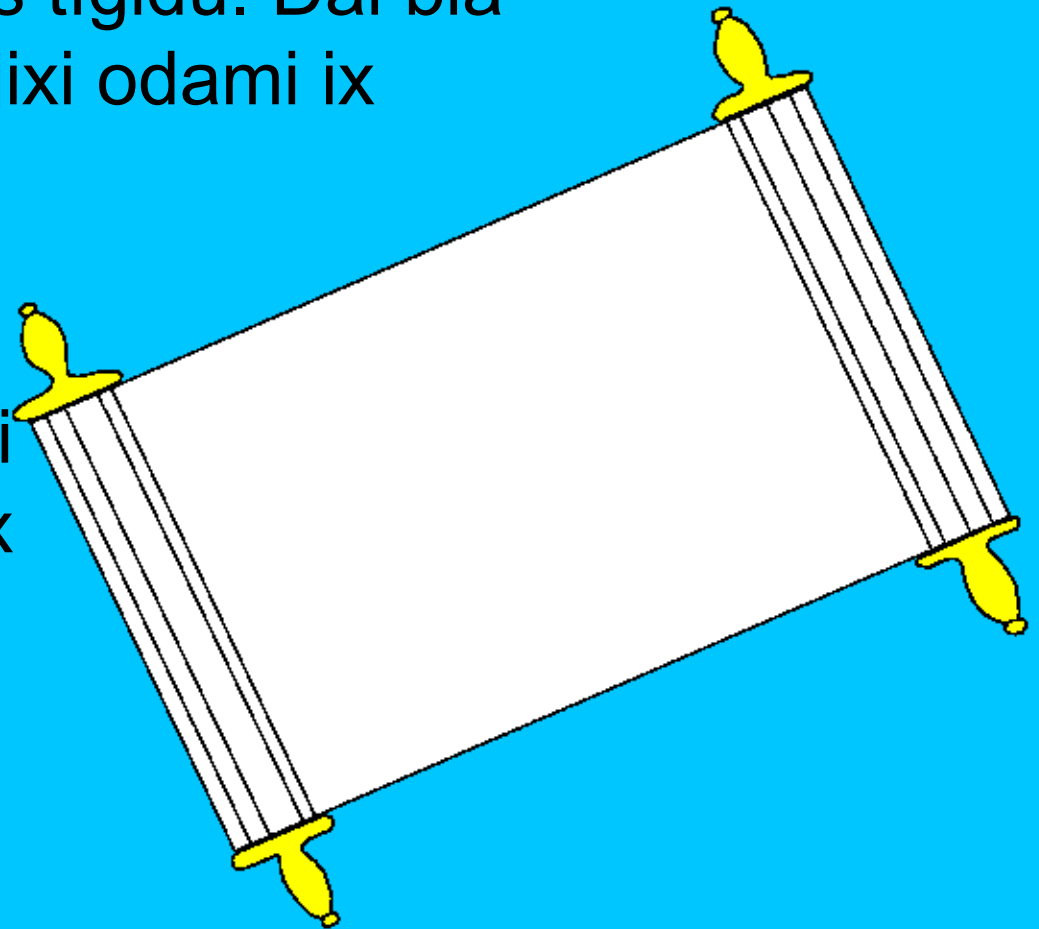

Dai Diuxi Ibhīadī bapaidimi bīixi óidakami. Dai go buaboitudadami ix makīdī ir nobiagadī dukai go Arhi Kañiru bapaidimi bīixi óidakami ipī. —Gimibīrai dai gīr uraba— ikaitimi īgai.

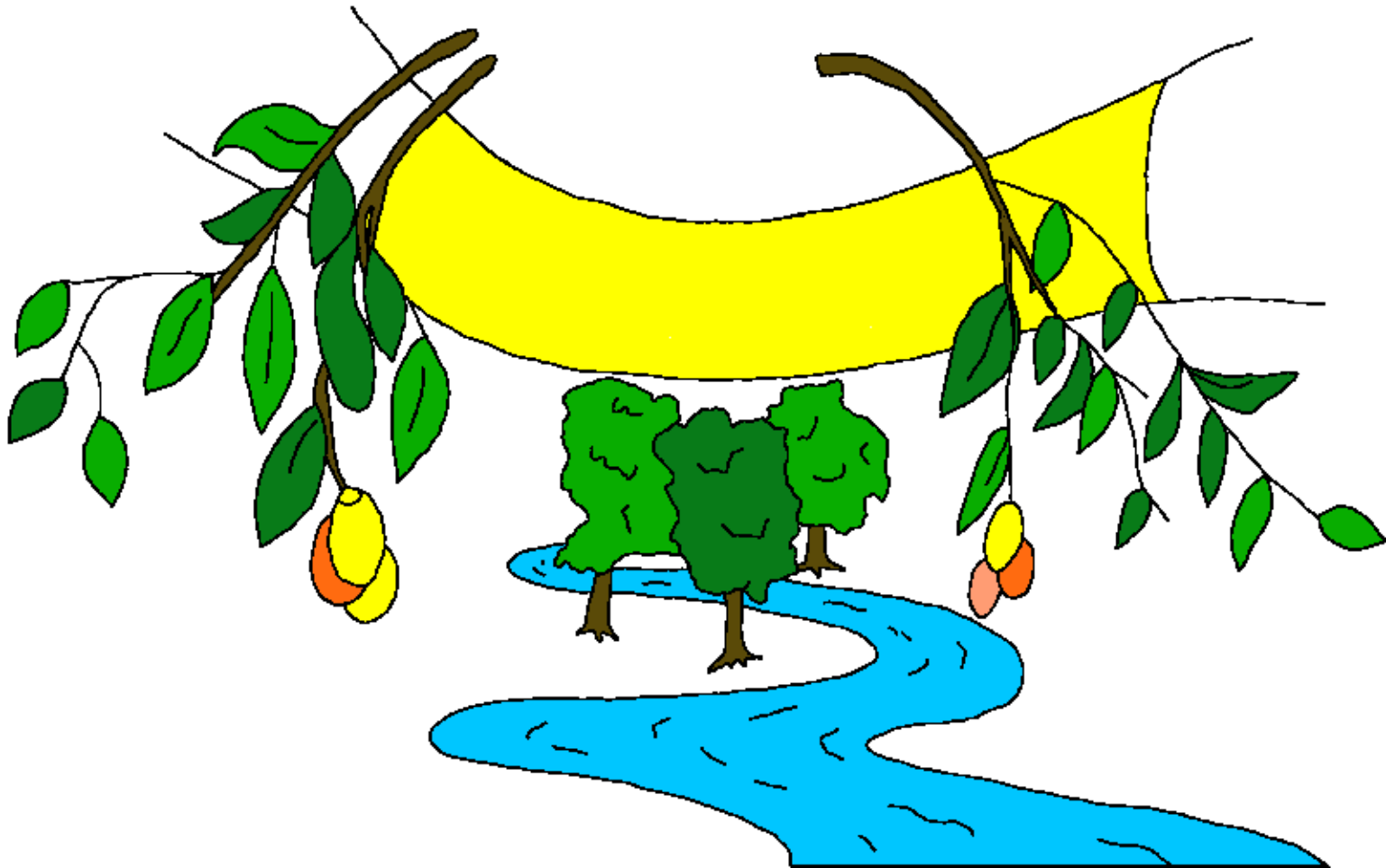

Dai bïïxkatai xorai kaïkagi go ñoki idi libroañdïrï gï agai
xi bapaidagi jaa dai abïnakiadagi sai urabana ipï.
Xorai tonokoñikagi gï agai xi dibiagi tudu dai iiyagi go
sudagi ixtukïdï kïïgakïrï óídaga odami. Go sudagi ix
makïdï gaoidi Diuxi tudu dai buaboikïdï ïr oidaragai.

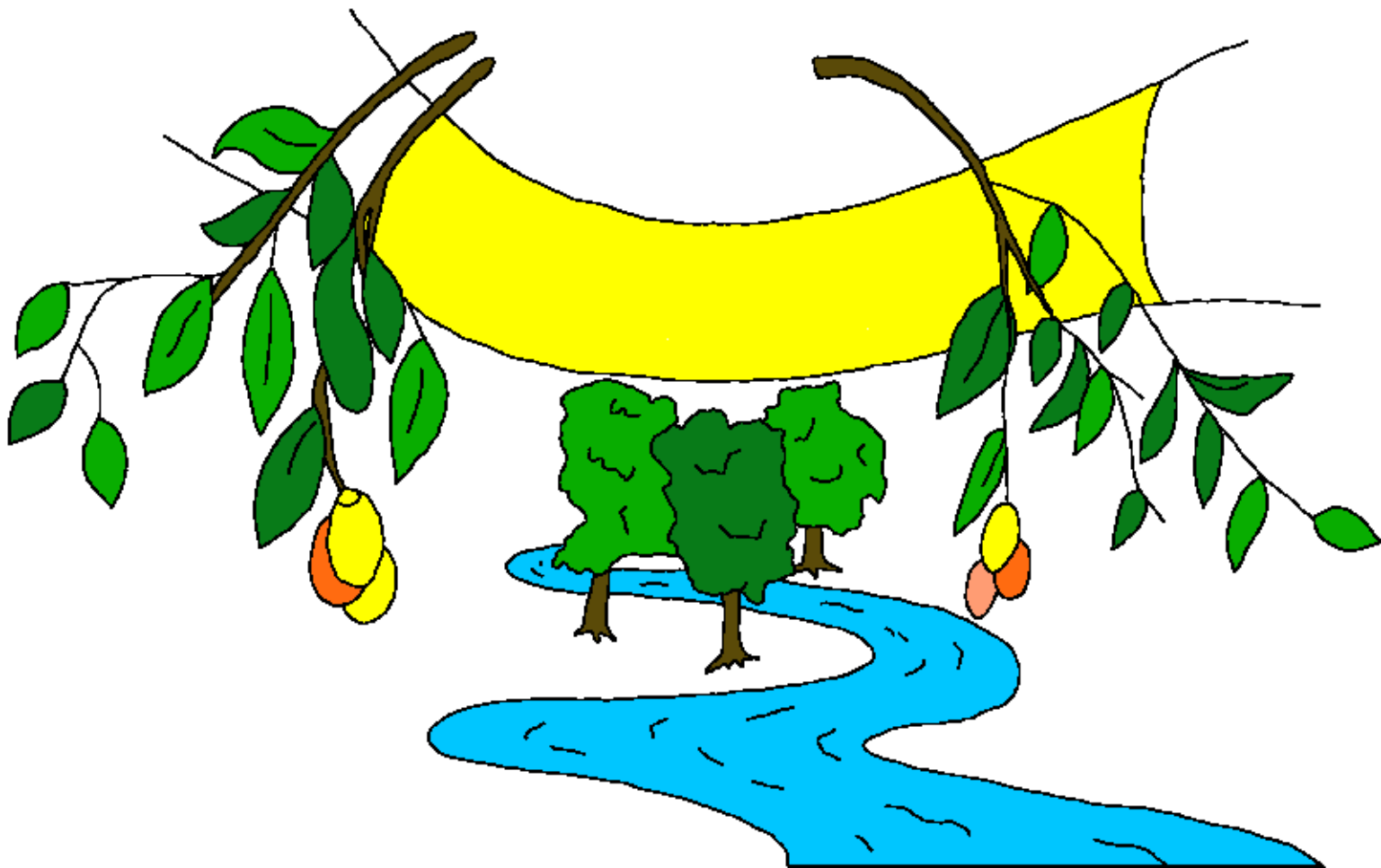

—Diuxi sīrhikīdī kīiga oigīdai bīixi oidigi
daama óidakami dai kaxkīdī gin otoi igai
aanī ix makīdī ir Maradī imadugakīdī.
Gin otoi igai an sai mukuna bai mai
kona ix makīdī gin buaboitudagi
dai bhayoma bīixkīrī bīitarī
óidakana.



Romanos 3:23 Daiñi, Diuxi sïirhikidï kïi tuiga dai kïi tiodi dai bïixi óidakami ïr soimaaxi buadami dai mai ajïi Diuxi.

Romanos 6:23 Go soimaaxkami maitïkidi ïr go ïi mukigami tudu. Dïi gia Diuxi gïr maakai ïmo oidaragai. ïgai gïr maakai ïmo kïigakïri oidakaragai bïixkïri bïitarï tudu bïinakatai aatimï Gïr Nukadakami Suxi Kristo.

Hebreos 9:27 Daiñi, odami mos arhi ïmo imidagai mumukui. Dai gokïiri arhi ïmo imidagai aagada agai Diuxi ix bhai kïiga dui ïgai xïipi xi mai kïiga dui ïpi.

Efesios 2:8,9 Kïi tuiga Diuxi gïn bïitarï kaxkidï kïigakïri bubuaka aapimï buaboidakai. Mai kïigakïri bubuaka aapimï ïigi gïn gubukarhigakidï tudu. ïmo oidaragai gobai ix makidï gïr maa Diuxi bhaiyoma.



Odami maiti ixtutuidikii xi iigi kiiigakirii gin bubiadagi aaduindadikidi. Kaxkidi mai tipuka agai xorai potiiyagi sai iigi gubukarhigadikidi kiiigakirii busai. Mai tipukamu ixtukidi gidukidi gi aagagi tomarhi imadutai aidi.

Romanos 10:9,10 Ga aagidiña aatimi sai gi agai xi odami buaboitudaitai po tiiyagi sai Suxi Kristo bixi adaama ir Tianidami. Dai sai gi aagai xi kiiigakirii buaboitudagi igai ix Diuxi duakaturhi go Suxi. Xorai pobuadagi gia kiiigakirii bubuaki agai.

Diuxi kiiigakirii gir niidi buaboitudakai aatimi tudu, mos maaxiko aagakai ix buaboitudai aatimi.

Juan 3:16,17 —Diuxi siirhikidi kiiiga oigidai bixi oidigi daama oidakami dai kaxkidi gin otoi igai aanii ix makidi ir Maradi imadugakidi. Gin otoi igai an sai mukuna bai mai kona ix makidi gin buaboitudagi dai bhaiyoma bixkiri biitari oidakana.



Diuxi gin otoi oidigi daama mai xu sai aagana aanī ix tuma gīgibituldaragai ajīga óidakami. Gin otoi īgai bhaiyoma an sai kīīgakīrī bubaidana óidakami— itītīdai Suxi.

1 Juan 5:11-13 Diuxi gīr aagidi sai gīr maakai ibhīdagai utudui sai kīīgakīrī óidakana aatīmī bīīxkīrī bīītarī mos buaboitudakai aatīmī Maradī tudu.

Kaxkīdī gī maatī sai xorai buaboitudagi Diuxi Maradī ka bia go kīīgakīrī oidakaragai bīīxkīrī bīītarī. Dīī gia odami ix makīdī mai buaboitudai mai bia gobai.

Daiñi, gīn ojidi aanī aapimī ix makīdī buaboitudai Diuxi Maradī saidi kīīga maatikana aapimī sai ka bia aatīmī go utudui oidakaragai ix makīdī bīīxkīrī bīītarī kabakarīi.



Juan 14; 2 Korintios 5; Apokalipsis 4, 21, 22

Storyline by: Edward D. Hughes

Illustrated by: Lazarus
and Alastair Paterson

Adapted by: Sarah S.

Tepehuan Northern (ntp) Copyright: Ethnos360 Sanford,
Florida

<https://www.bible.com/en-GB/bible/3339/GEN.1.NTP>

©2025 Bible for Children, Inc.

www.M1914.org

www.bibleforchildren.org

