

www.BibleForChildren.org

Jon 14

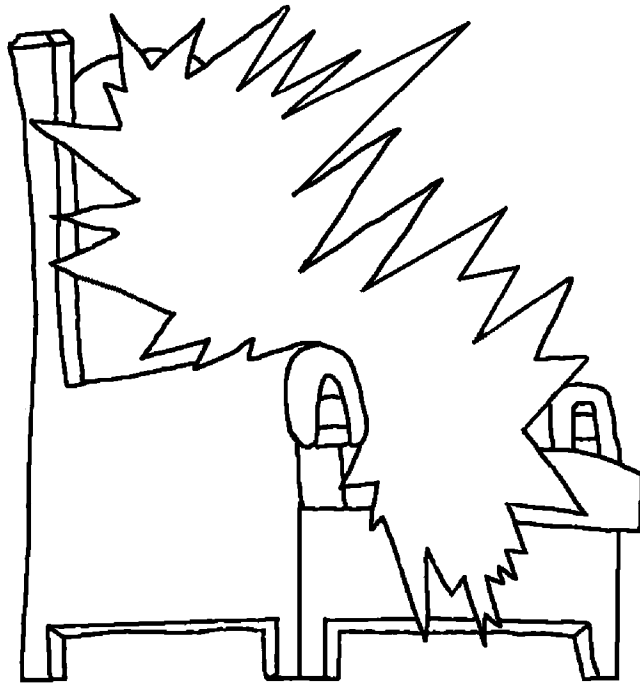

Yesus ayo almi daang bakaalin tunum iyo
bokoya-lomda: Ibi aket mafak mafak fukunin daa
kabak-ami miit kaali, God almi weng kaa boko-lomda:
Kaata kanolokomi no, kalsa kaali, faneng ti kanolokoma
no, kalbip-kup, ale kanola nami weng bokoya-lomdi: . . .



. . . Kaata kanolokomi no, kalasii kaali ti, kakal ti faneng kanolokoma no, nakan-kaa-bam kutal-fukulin-kup ke-bamdip, ibi aket mafak mafak fukunin daa yo, kala-somla ko. Nimi Atok ami am kaali, abiin yaapkan bom-bilip kemin, nali din-ilomdiya, ipni am abiin kiili dot-mokomi.

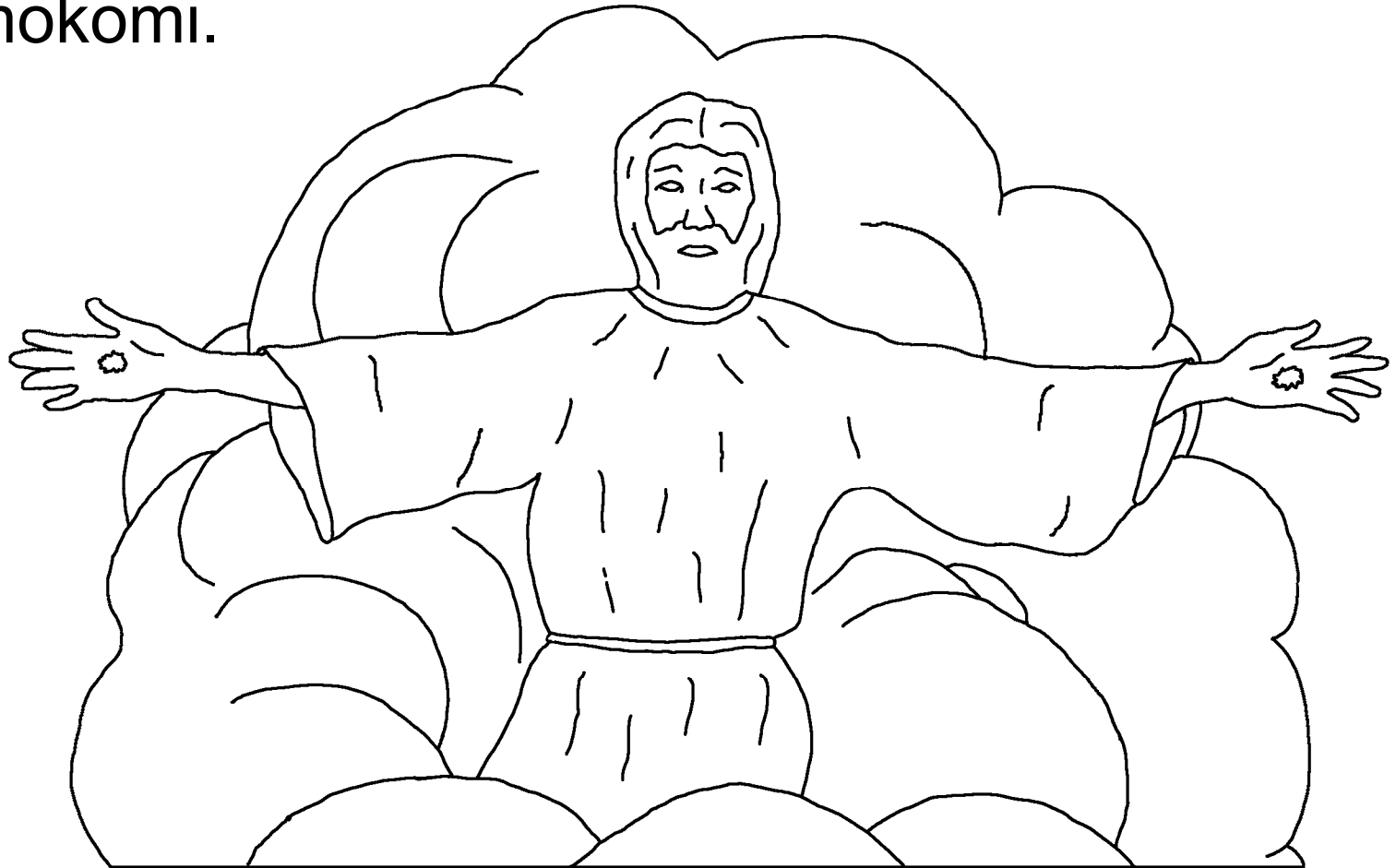

Kaali kanolin disa dinam, nali kanum bokoyilami disa.
Kanola nali din abiin talalu-yokomi kaali, nali asuk tal
ipni imbii-din daali, kipso naso maakup ilokomu.

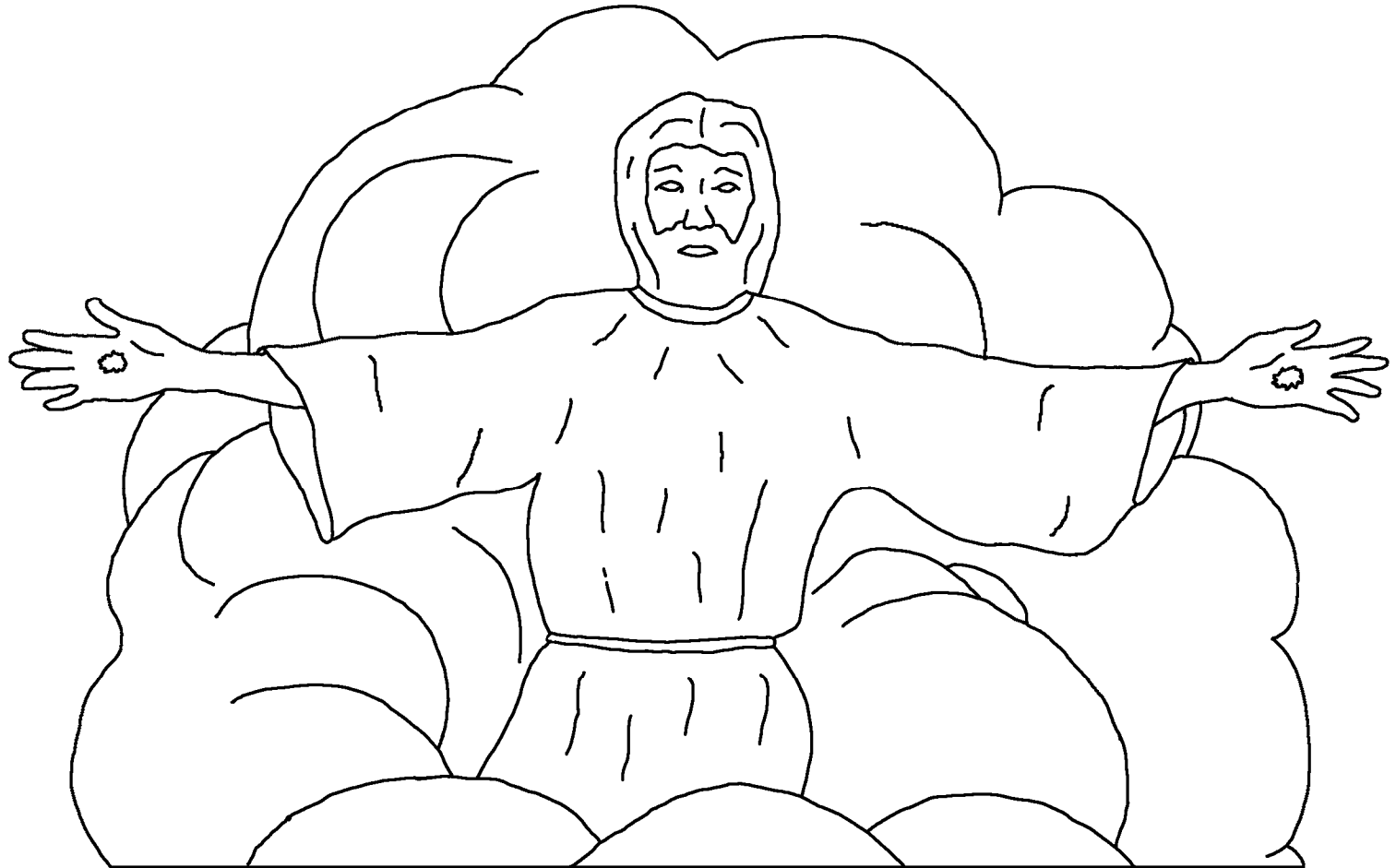

Kipsole, kaptum Jon naso, nikil nuli Yesus ami lak
kaata duulupla, tiltam almi miit tem uyo tiltam
tal-sulup. Kemin, kaami kalan kaata,

Yesus ami waasi ita kukup
mafak ayo

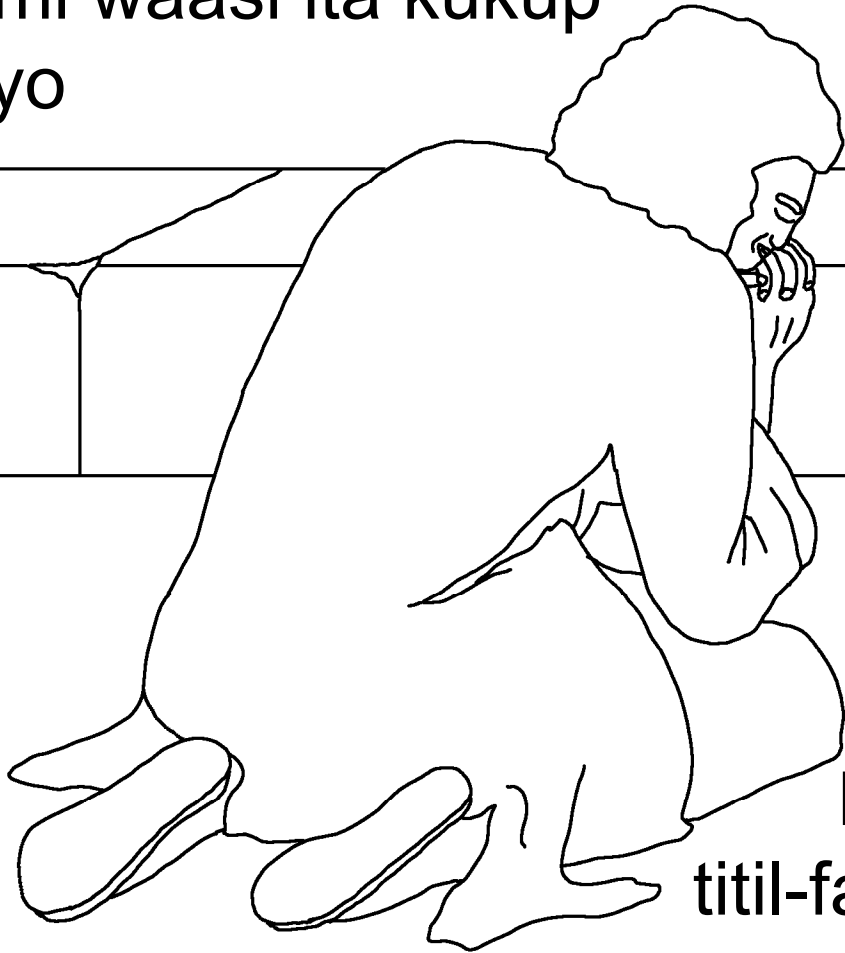

kukaayim-biliwa,
angtiil yol ayo
dakan-tabasup.
Kanolin la, ti suunkup
titil-fak-daa tabasup.



God ami weng so, Yesus ami weng kaa
bakayila-yaabi kaami kalan uso, kiita sok
de-nam-bu nam-tama yol ok daang kun

diim liip nam-tal ok ding yol
ok iipyak diim bokon biim

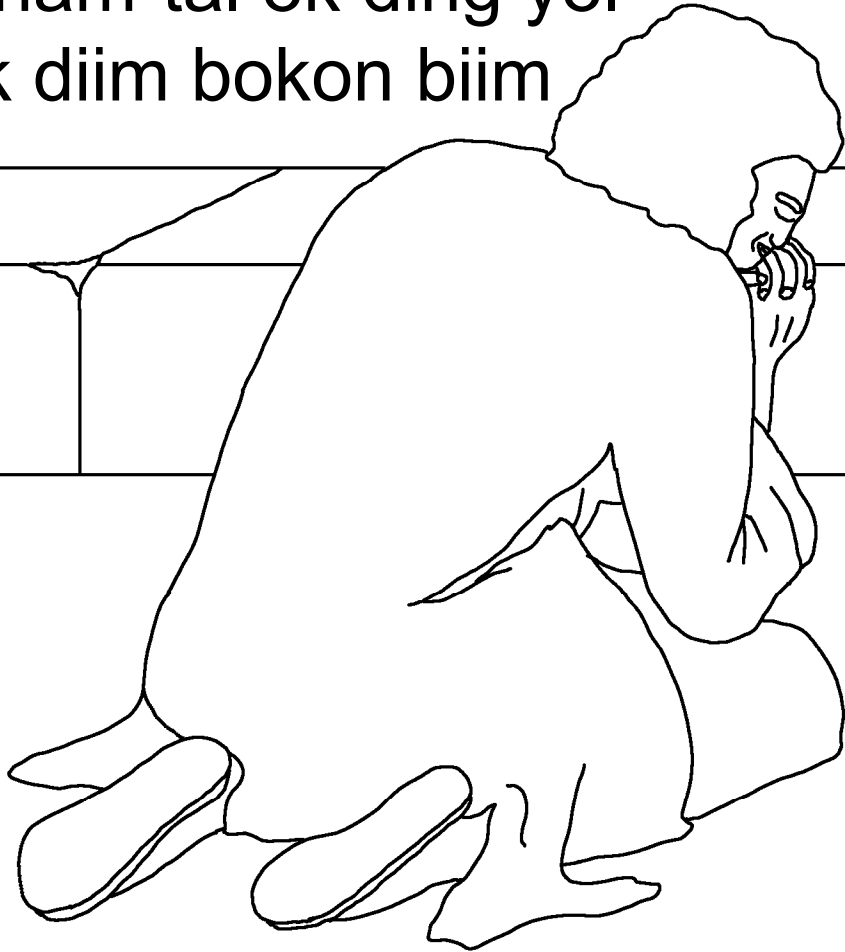

katip Patmos o,
kebip kaa daaliwa
kawu bomdila, . . .



... Kamokim Yesus ami iintang am ma daanu kulu,
God ami Sinik ayo kukup-nam-balaya, lom tap
dakan-um-bom weng seliya, nami

daang tem kaltam-ali weng
ma bikul weng tap ma



dukum-kup naanba
kala kem-silile,
bokop-na ko: ...



. . . Kabi kanumin kanumin mafek mafek
uta-mokomap uyo, sukun diim kabaku
dola-lomdap kulaalap din nami unang

tunum abip ma ma Efesis,
Smena, Pegamum,

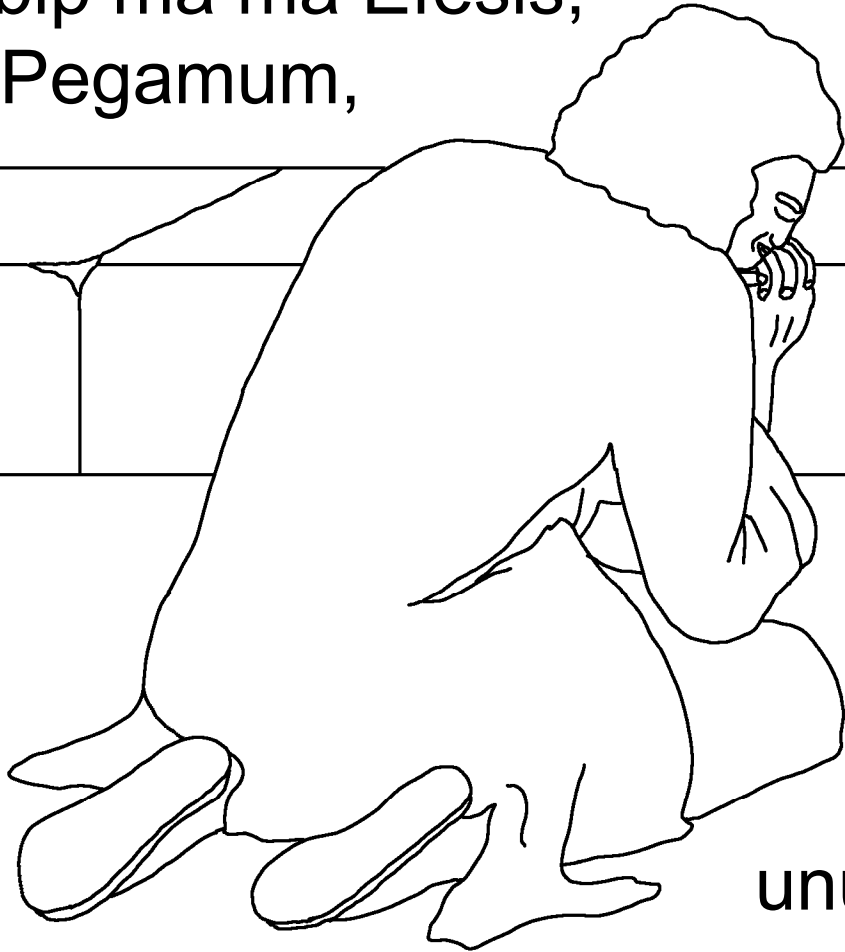

Tayataira, Sadis,
Filadelfia, Laodisia,
kunolin abip fetkal
bom-bilip imi bilip
unuk o, naka ko.



Ma kaali, Jon nayo lom tap visin o kebip duuliya abiil tikiin kaali, saal uyo ma busuulula utami ko. Kamosinim ayo bikul weng tap ma uta bokop-nu weng sebi kemin, asuk weng seliya, kanolin weng ultap ma abiil tikiin kaptamu bokop-na-lomdu:

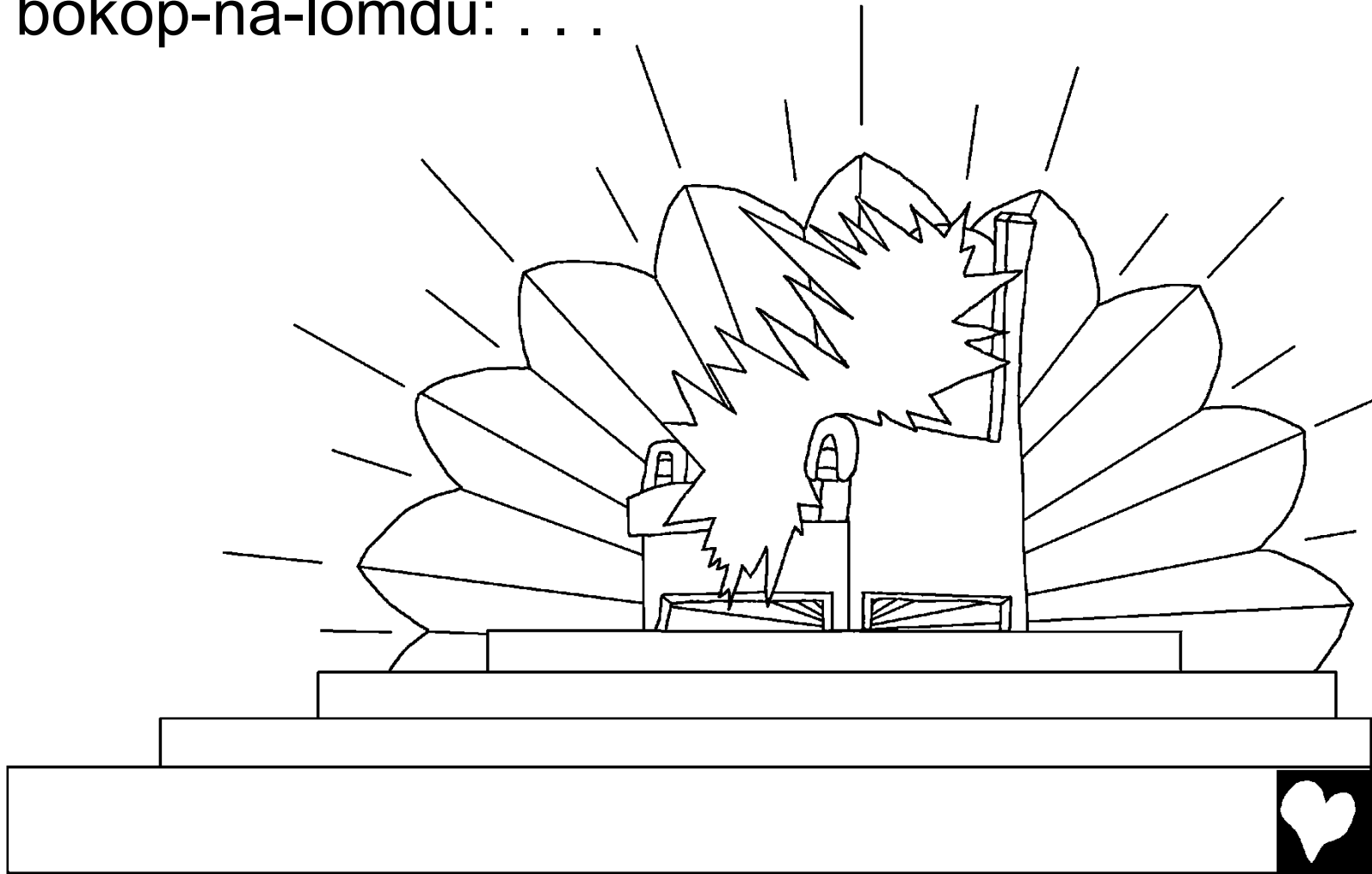

. . . Tiltam talawa, bom ilom mafek mafek kaami tiltam
tabokomu kaptoop-ata kukup-ton o, kalule, kulu maak
fak-daalin tap, God ami Sinik ata nami sinik ayo
dap-tam abiil tikiin daalaya, utam-talaalila, Tunum ma
kamokim king o, kala-laabip
ami tiin-bomda alik kiimi
tiin-saanin baan diim
kabaaku tiinba
kaa kali ko.

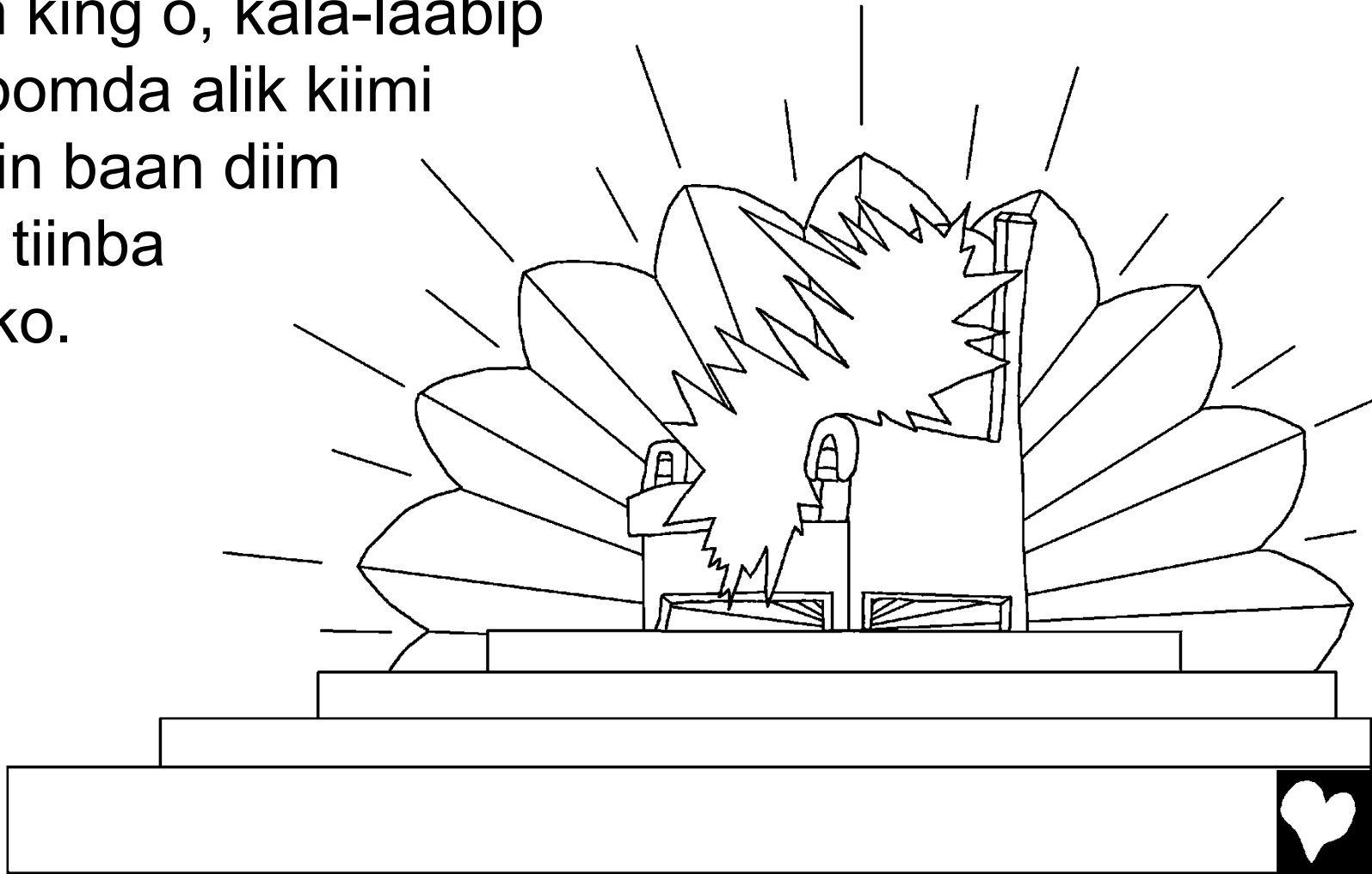

Kemin, nayo weng san-ilomdila, mafek mafek alik tiin
kawang-bilip, imi abiil tikiin bom-bilip iso, tawaal diim
bom-bilip, tunum unang taansip imi
abip bom-bilip aa, yol ok kumun
tem bilip iso, iyo alik maakup baal
wiibip kala weng seliya, baal wiibip
kabak-ali boko-lomdip: . . .

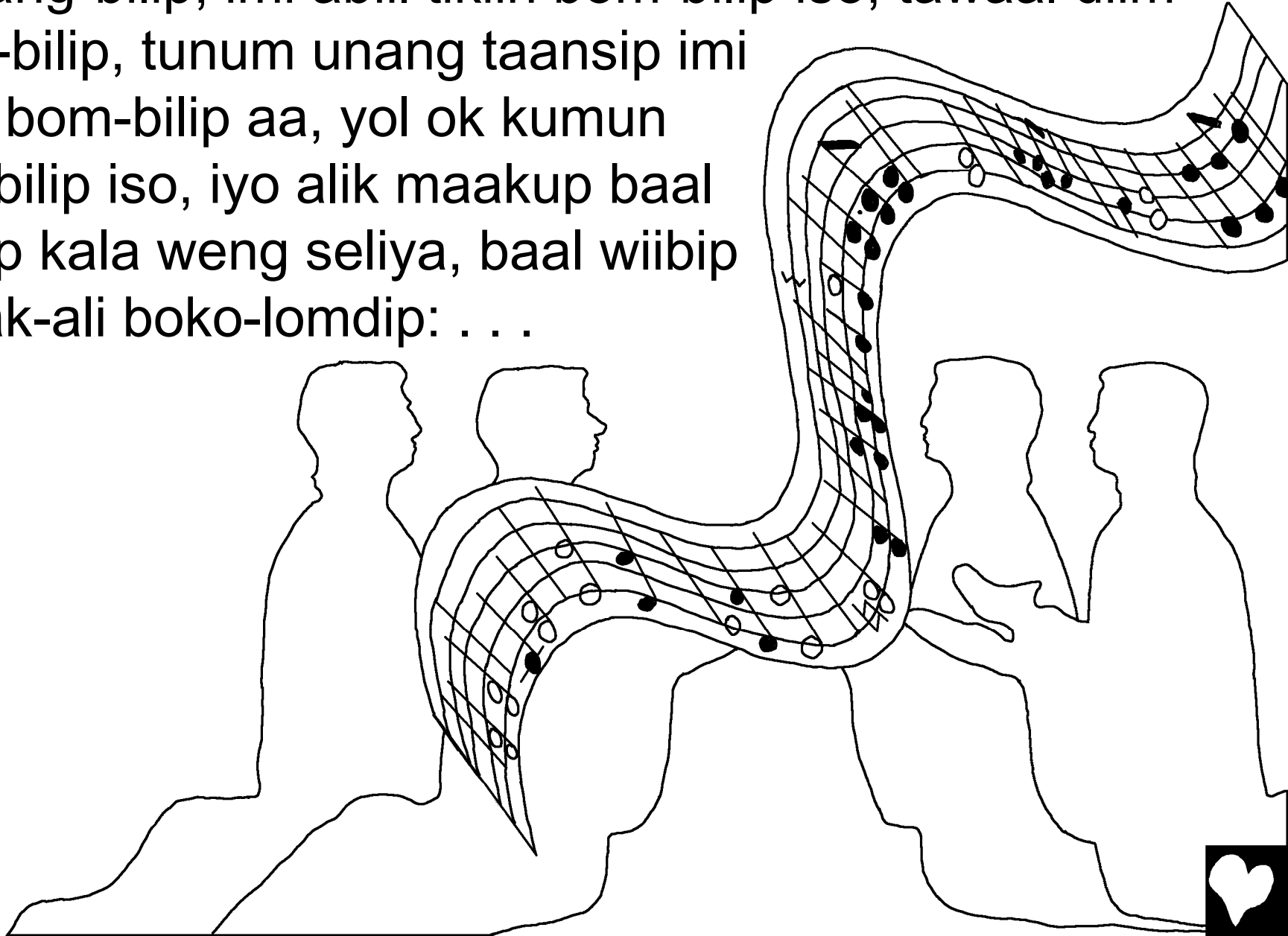

. . . Alik numi tiin molin tunum God asole, Sipsip Man
aso, alim ibi Dukum ale, titil miit kayaakal o, kalalupla,
alim kipni fiyaap ayo tabe-bam yaap
ke yo, kemum o, kala-somla
kemin, nuli suunkup baal
wiiyim-bam ale, kipni fiyaap ayo
duu-bam ke-mokomup kayi!
kal-bom baal
kutiiyip.

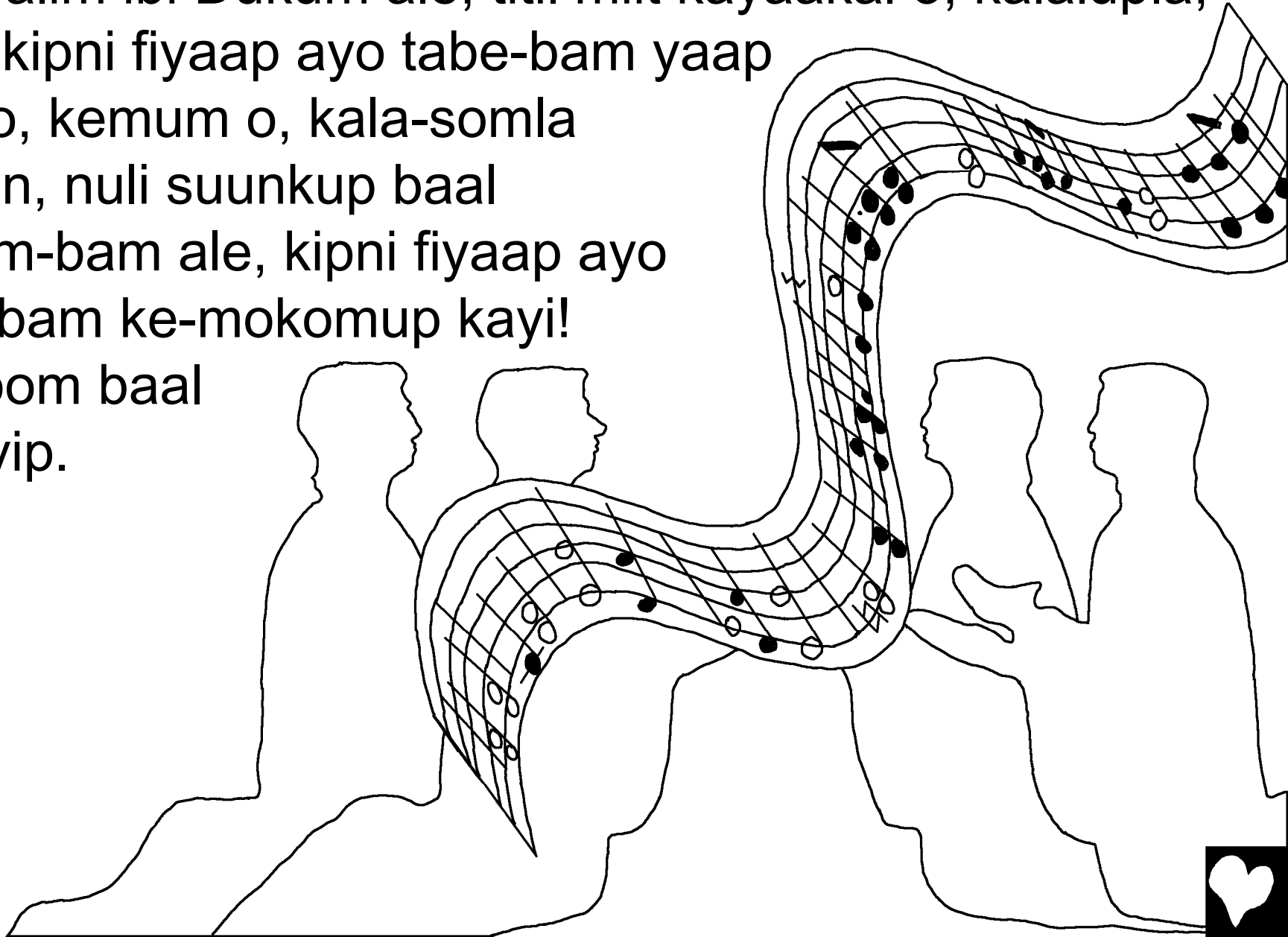

Kemin, kuno nali talaalila, God almi kama alokso abip
Jerusalem uyo abiil tikiin kaptamu kutal-daak tawaal
diila utamile, alokso abip uyo disa akal ma kutookso kiit
kon tiibi ke-umbip kaali, unang ilim tambal mikilu tunum
ket dabuulon o, kalalu imak liip fenbu tap ke; God ami

abiin baan
tiin-laamin sia
diim bombe
kawu, weng
dukum ma bakaba
ayo weng seniya
ayo boko-lom: . . .

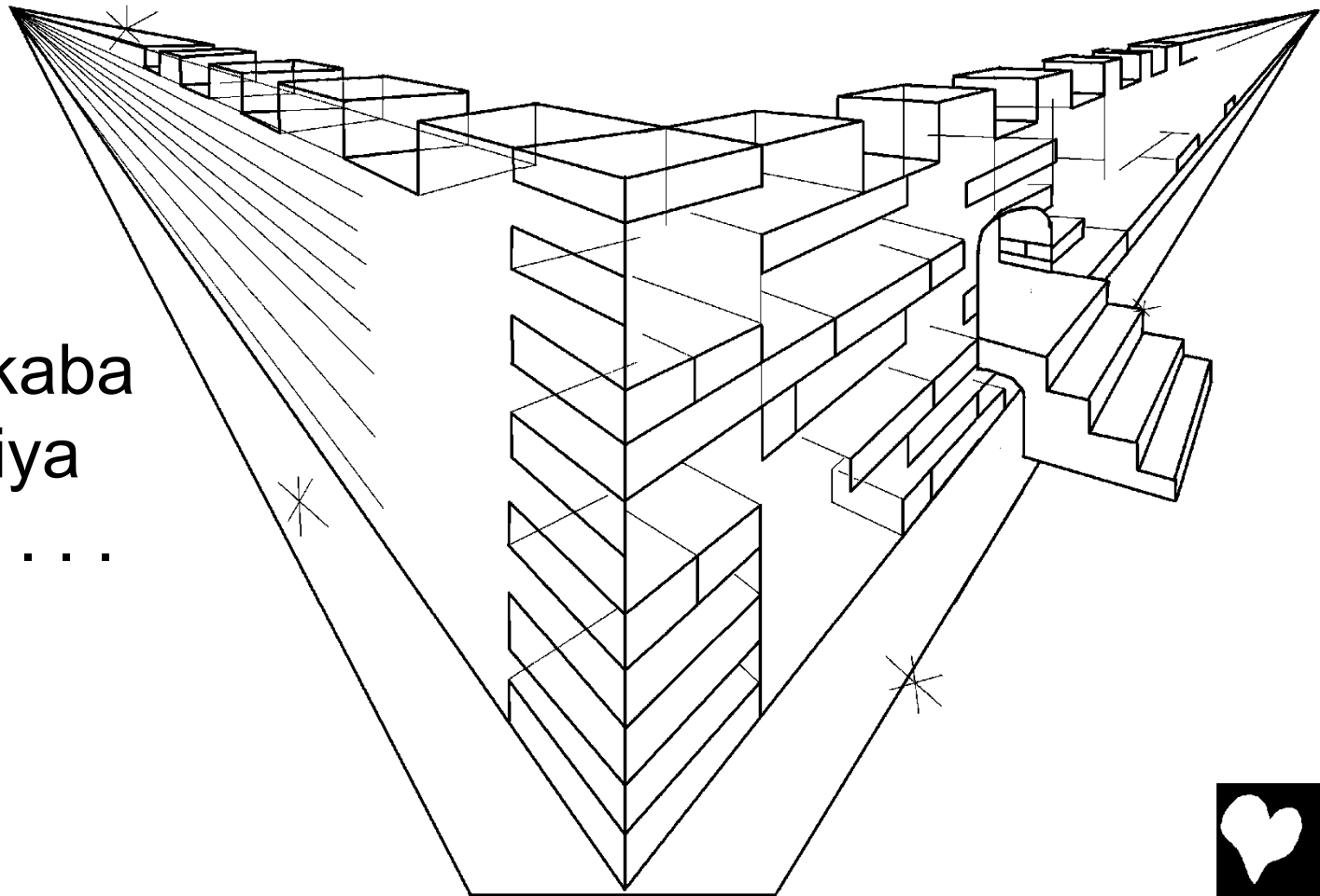

. . . Kipyo, weng san bom-iliwa, kamala kula tabup uyo,
God almi unang tunum iso, bomda almi mepso kulu
suunkup bom tiin molaya, unang tunum iyo tal almi miit
tem unipla, ata imi God keya-lom tiin moyokoma.

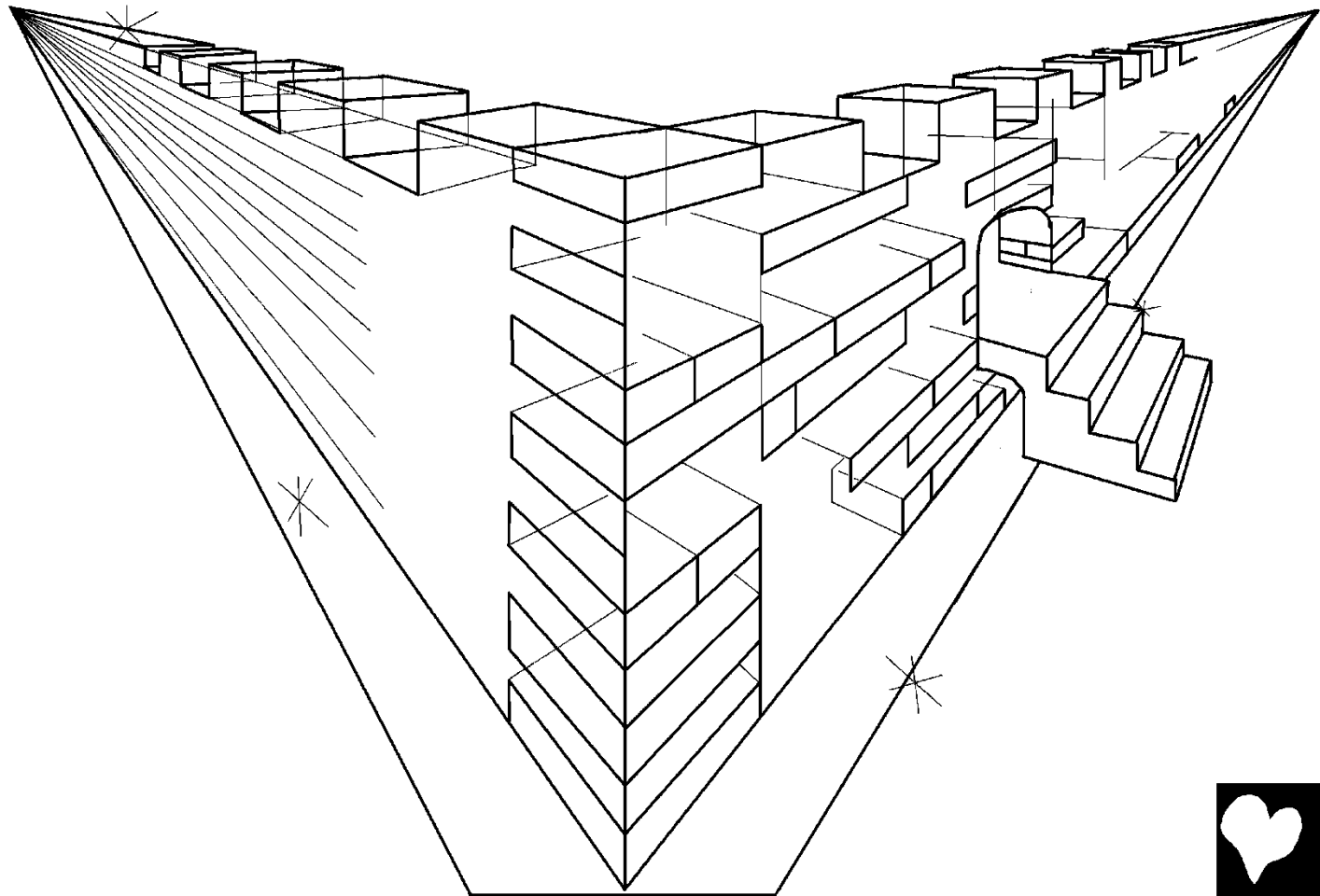

Kemin, ensel ayo Jon nami kukup-nala atamiya,
suunkup ilin ok ayo milmil tawaal tem ok kemin, God
aso, Sipsip Man Yesus aso, alim imi tiin-bom ilin baan
diim kaami minlo tem kulu foko bina kulaala abip liip
aalap dukum kaptoop ba an-kulii una, ayo ok kaami
iipyak tem ayo asak-lamlaam-kup sikinbi kuusa le,
mep fan am ami glas tap kelin, . . .

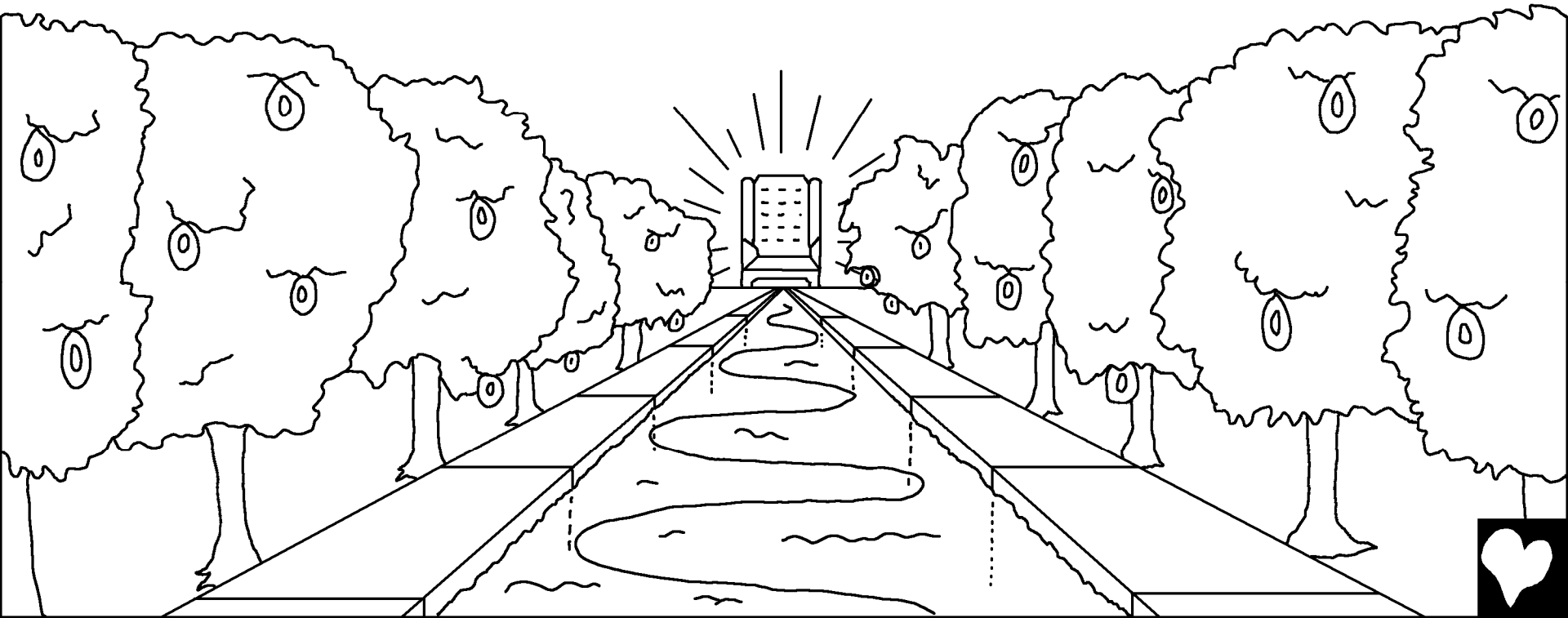

. . . unang tunum iyo kanta ok kalawaali inokomip uyo,
suun ilokomip ale, yak ok malii so, tildak malii so, ok
balang diim kaa suunkup ilin as tolsa kaami lap ayo
abuubu kemin, umi abumin uyo abu-abu kemsideng
talangkal wasital maakup ami diim ayo kanumin kemin,
uyo kayoop maakup maakup kaa abuubu ke-laabu no.

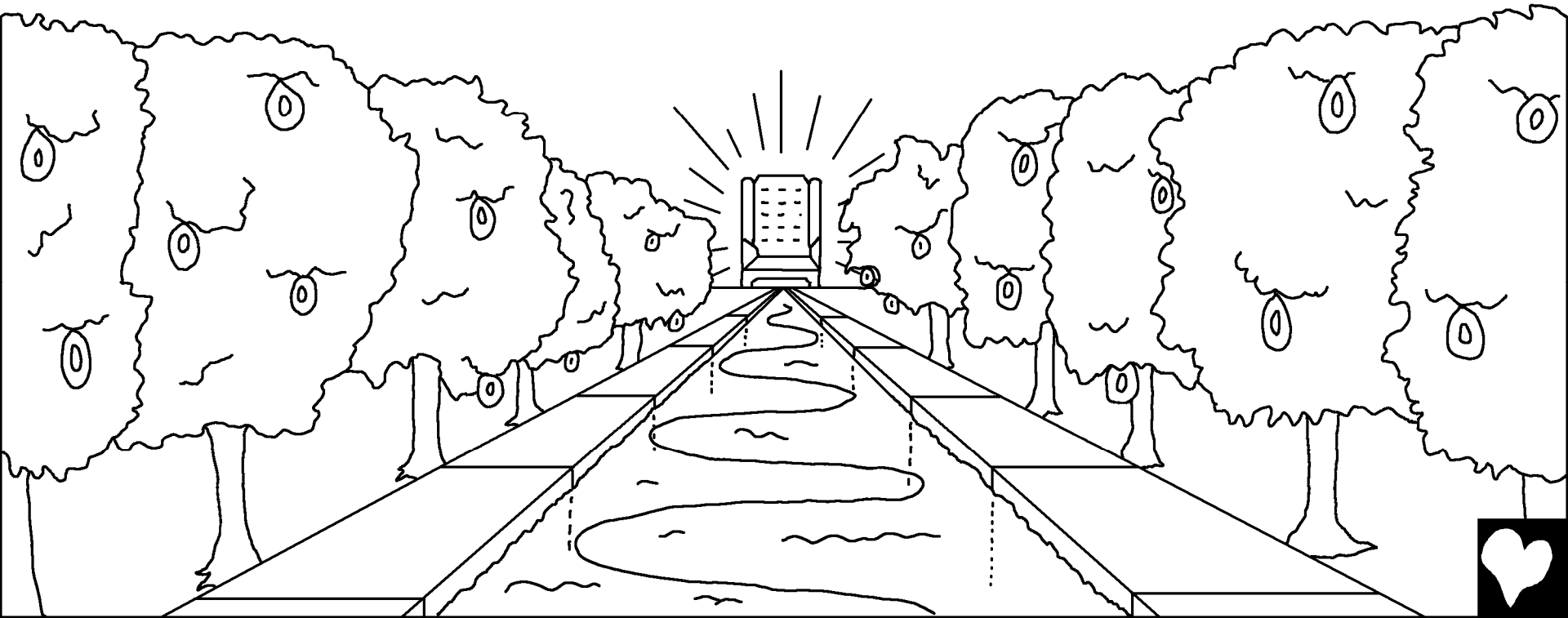

Tunum unang imi tal as lap kala duk-duu inam-nokomip,
uyo suunkup iyo ilokomip. Kemin, am bokon alik kala
dik-daa kulaasu kaami unang tunum miit ma miit ma ili
suunkup ilin kaami as kalaami kon kaa, marasin ultap o,
kalaliwa, inan-yaabip kemin, uta dong dakaayim-bulula,
imi angtil so, aket fanang dakamin so, uyo mafak dinim,
tambal-kup ilokomip.

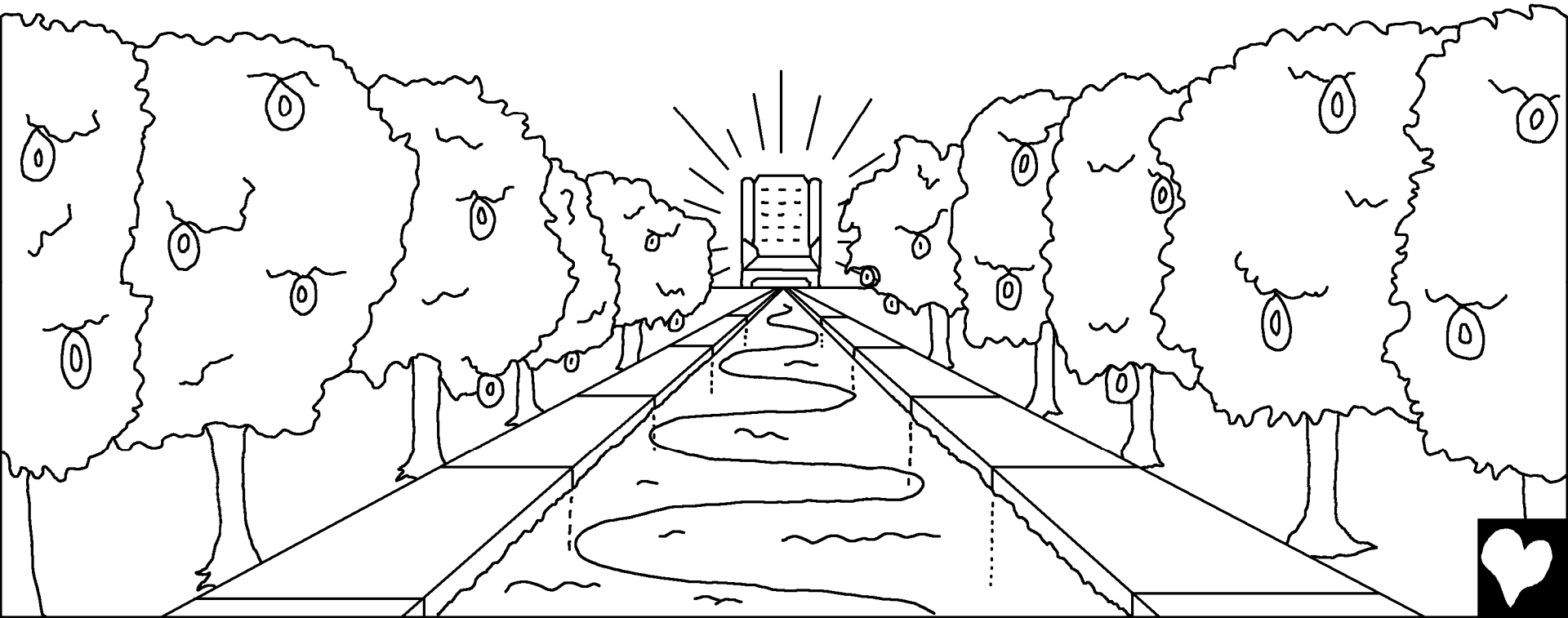

Kemin, God so, Sipsip Man so, alim imi dawang dukum
kaata kulaalip taba-lom abip uyo ilfo falala-kup kalula,
abip kasel imi mafek mafek iyo talalu uta-mokomip.
Abip kaptam-ali atan dinim, kayoop dinim. La, abip
kasel ili alim imi dawang diim kawu mafek mafek iyo
soko talalu uta-mokomip.

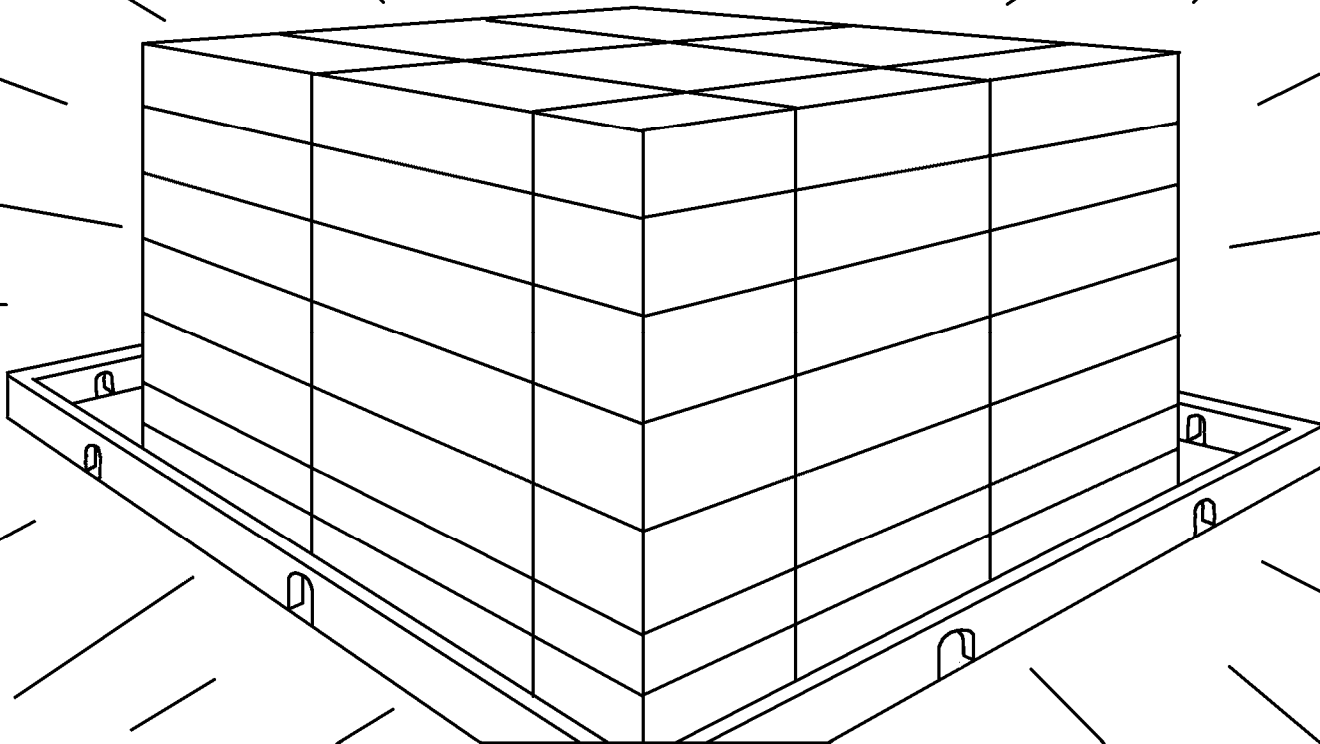

Kemin, ili mafek mafek mafak ma kulii tiltam abip
kaltam kulii tiltam talokomip dinim. Dok kanolin unang
tunum ita fatom tabin kaami kukup
aye, kasen-fakamin kukup
aa, kotal-fukulin kiili, abip
kaptam tam unokomip
disa. Atin disa; unang
tunum tituun-kup tabasip
imi win kiita Sipsip Man
ami buk tem kabaku
dol-yinsa ita-kup tam
atamiple, aso maakup
suunkup ilokomip o.



Kemin, God ata mafek mafek mafak tal unang tunum
imi diim aben-umbu uyo, alik kukan-tiiyokoma kemin,
aket uluum ke-mokomip disa; ama-mokomip
dinim. Kemin, tawaal kala disapsu
kaami mafek mafek mafak kuluu
disa ke-lokomu. Kemin, taan-laamin
so, angtil yol tabemin kulaaso,
aket uluum dukum so, amamin
aye, kiiyo asuk maso ma tiltam
talokomip dinim; atin disa. Ili ti
atin alik maaklo disa
ke-lokomip o, kema ko.



God ali mafek mafek so, unang tunum so, ili ma: Daa
yo! Kibi mafak u, kaloma kaali, God ami abip uyo tiltam
talokomip dinim o. Alokso Jerusalem uyo God so,
Sipsip Man so, alim imi tiin-bom kama tawaal dotulip
tiltam tabokomu kaami
alik tiin molokomip
kaami baan diim
namti kaa bombe.



Kemin, God almi unang tunum kaptam-ali alik God ami lotu kaata kamaan-bam ale, kulu ili God ami tibi kun namti utelokomip ale, God ami aket fukunin kaali, Nalmi unang tunum o, kala, kalalaya, ensel iyo bokoyilaya, yakal God ami win uyo

God almi unang tunum kesip imi tibi kun diim kulu dol-yilokomip o.



Nali utam talaalila, Unang tunum saaksip iyo tam tiinin
disa bom-bilip iyo, tunum win soyal sole, tunum win
dinim so, imi saaksip ita kala kalile, alik iyo yakaba din
God ami tibi diim kawu tolniwale, God ami buk ma bilip
kabak-ali tunum imi kukup mafak sole,
kukup tambal so, kanun-yaabip kiili,
kabaku dola-yaabip kemin, ensel
iyo buk uyo baa-kutii-lom,
buk ma kuuli God ata
unang tunum suunkup
ilokomip imi win dolsa
uyo bam-daa kutii kelip
kemin, . . .

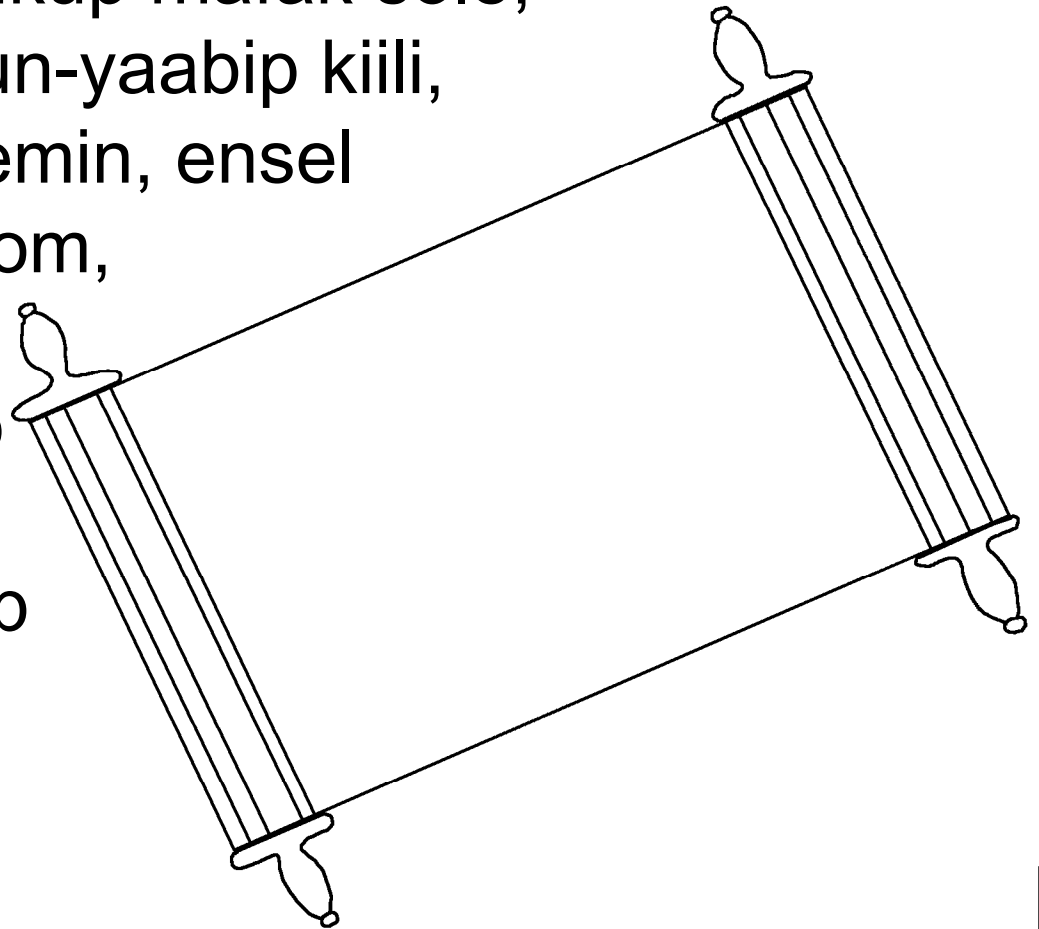

. . . kulaa God ayo tunum imi kukup kanubi taansip
kaami sang kaata talalu utafii-bam tik-tiiyim-bam ale,
imi kukup kaa kanun-umbip kaata, maan tiiyim-bam ke,
tiiya ko. God ami yim-bak-saanokoma kaa, unang
tunum kanta ami win kaa God ami suunkup
ilin tunum unang ke-lokomip imi buk tem
kabaku ma ilin dinim o, kala namti,
ali alik fokola daak as kiin-bam
ilin kaami tem
unokomip o.

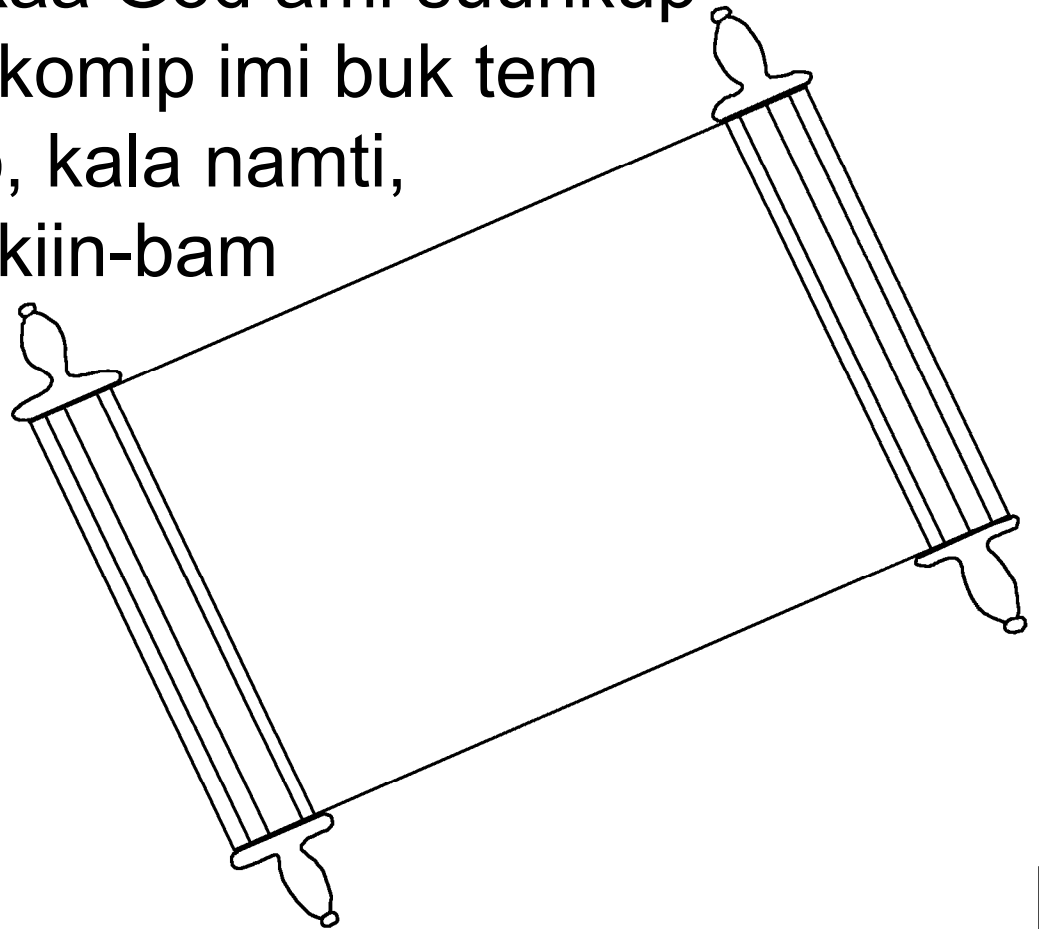

God ami Sinik Tambal so, Yesus ami lak duulin tunum unang miit maakup kelu almi kalel kuluulin tap ke yim-bii almi abip unokoma kiiso, ita kemin, Yesus ami bokola-lom: Kamokim kapyo, baan abiltap tal o, ke-biliple, kanola ultap alik ibi kanita weng kaa weng

sanip
namti, . . .



. . .Yesus ami bokola-lomdip, Kamokim, kapyo abiltap tal o, akin o, kala-somla ko. Kanola alik ibi kawanta ok del keya del kala ke-yimbu kalip namti, suunkup ilin malmil ok dis kulaa ma inamnum o, kalip namti, Yesus ami suunkup ok kaali, molokomip disa.

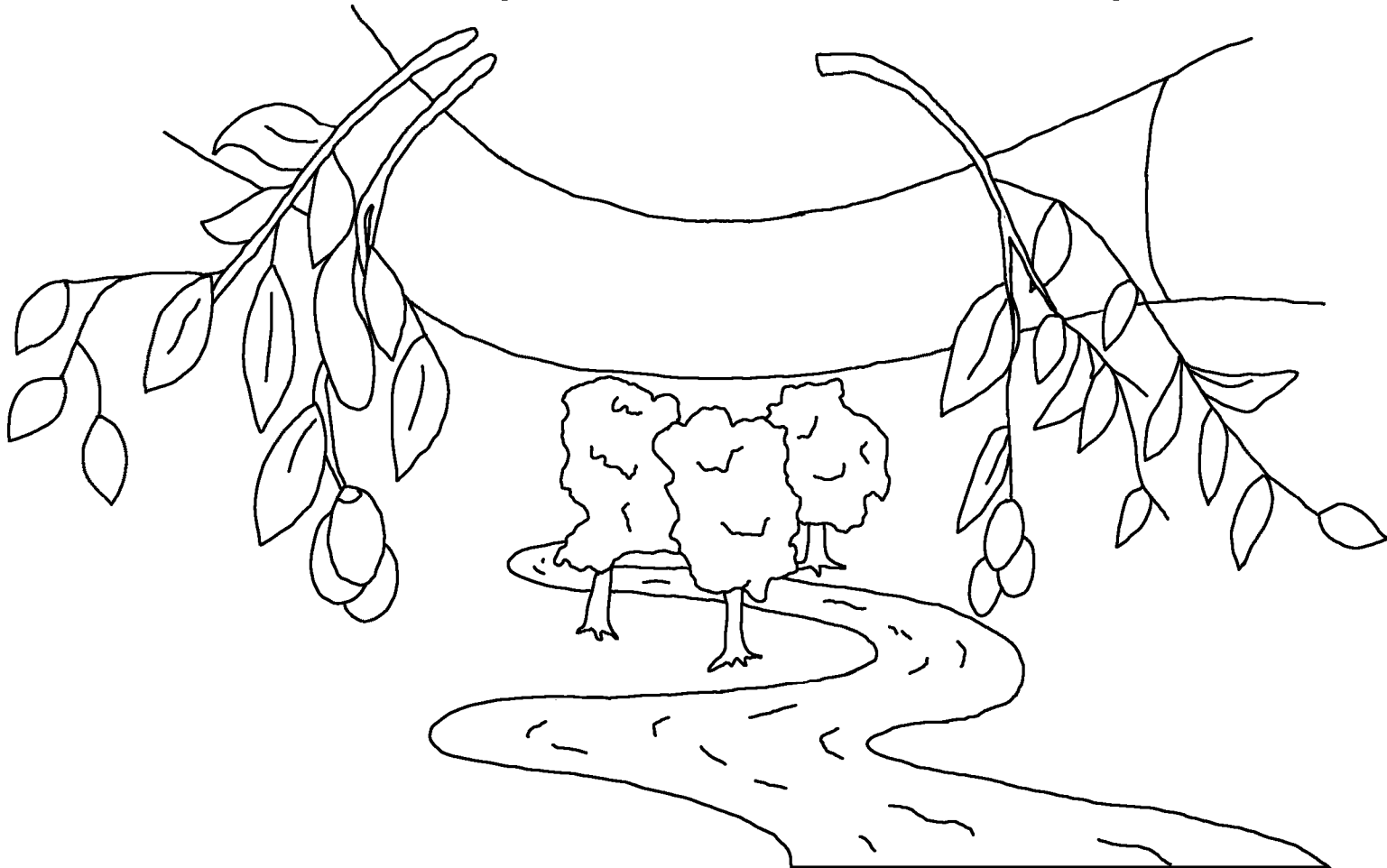

Disa kulu kuuyokoma uyo, tal kuluu inamnin aa!
Kemin, kaami inam-nokomip uyo, suunkup suunkup
ilokomip ko.

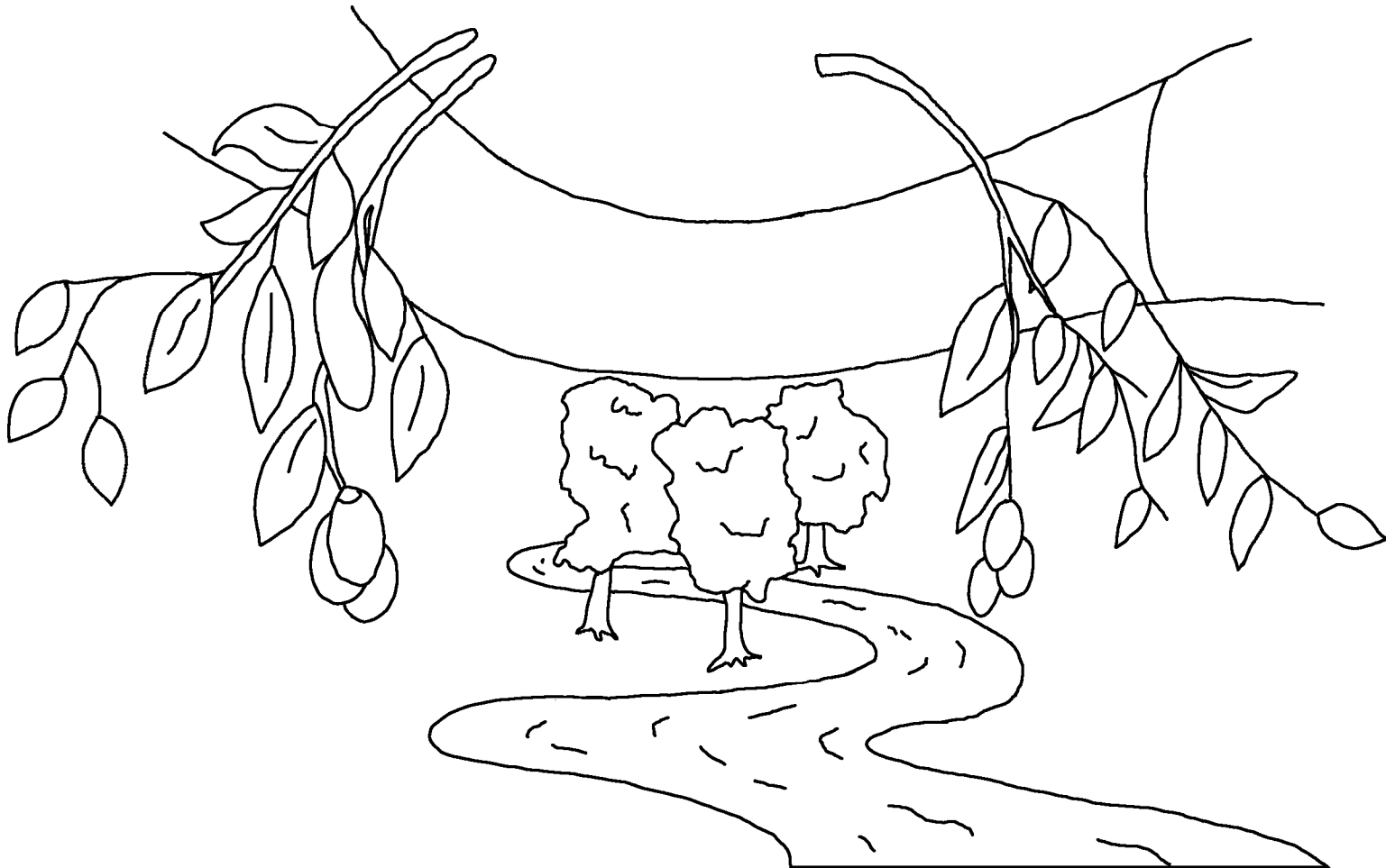

Kemin, God ami man ali yaan maak
ata-kup yale, God ayo tawaal diim
unang tunum numi aket dukum
kaata kuya-lomdala, kawanita
nimi man kaami lak ayo
duulip namti, kii maaklo
ke-lokomip
disa.



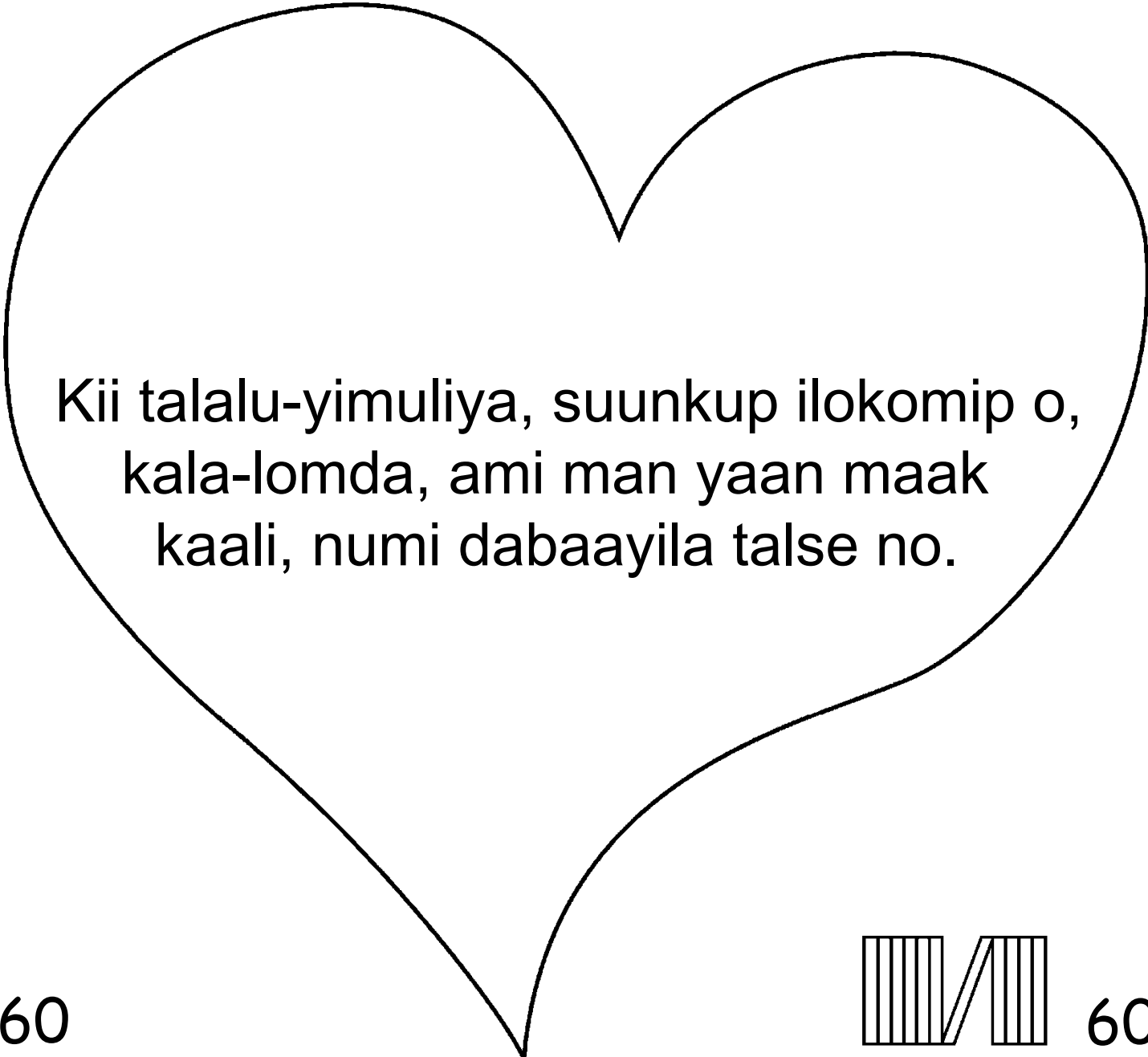

Kii talalu-yimuliya, suunkup ilokomip o,
kala-lomda, ami man yaan maak
kaali, numi dabaayila talse no.



Rom 3:23

Kemin, God ami tiin diim ayo tiltam tituun-kup tabin tunum kemin kaami liip namti kalabu: Unang tunum nuli akal almi alik akal almi alik disa; nuli ti ban ke-lom ale, God ami numi tong bakamakin ayo uktansup. Kemin, nokol ti kanola unang tunum alik ili kanta Yesus Kraist ami lak ayo duulip namti, ita God ayo bokoya-lomda: Ibi tituun-kup tabin unang tunum o, kala yaka-yaaba no.

Rom 6:23

Kemin, ban kuuta taba-lomdu ulmi ok tabuulin unang tunum kiimi ok fukulin ami sisol kukaayila-laabu. Kemin, sisol kabak-ali atin saaka-laamin kaata; yale, God ami kukup tangbal numi misiim kukaayila-laaba kaali, nuli yak Yesus Kraist ami diim fep-nupla, alta tiltam numi Kamokim ke-lomda talalu-yimuse. Kemin, ilom kaali, im-taldang almi miit tem daalala, aso suunkup ilokomup o.



Hibru 9:27

Unang tunum alik nuli ti du maakup ma fak-daa taanuple,
siin ilom am ma daanokomu kawu din God ami
yim-bak-saanin baan diim uyo din unupya, numi kukup uyo
ifiiyokoma te!

Efesis 2:8,9

Kemin, God ali ipni olen-daaya-lom aket bilili-kalin kaata
kuya-lomda, alami man ayo kuuyilaya, ibi Yesus ami lak
uyo duulip kala, kala-lomdaya, ipni iliim uyo boyase. Ibi
mafek mafek tambal kiita ma nuu-biliwa, God ayo kaami
maan o, kala-lomdaya, ipni iliim uyo boyase dinim; akal
almi aket fukunin kaata-kup ipni iliim uyo disa masiim kawu
boyase. Kemin, God alta kaata-kup kaa kanoyase. Kemin
ale, nuli dok kano-lomdupla nulmi win uyo kufolup tam tiip
kaptoop unomu dinim te!



Rom 10:9,10

Kanola kabi weng ku-fatap-daa, boko-lom: Yesus kaali nami God ale, nami Kamokim ke kesa no, kalale, kapni aket tem ayo talalu utamawa, Fan God ayo Yesus kaa kom tem kawu dafose no kala, kanum bokolap namti, kaata fan God ayo tam-taldang-daalokoma no. Nuli aket fuku-daalupla yi, Ali tifaneng o, ke-bulupla, God ayo bokoya-lomda: Kipni ban kemin kaami maan ayo disa keyulula, tituun-kup tabin unang tunum kelip o, kal-bom ale, numi Yesus ami lak dakaamin kaami sang kaata, nulmi bon tem kawu baka-bulupla, God ayo nuli im-taldang tii-bam kem-laaba.



Jon 3:16,17

Kemin, God ami man ali yaan maak ata-kup yale, God ayo tawaal diim unang tunum numi aket dukum kaata kuya-lomdala, kawanita nimi man kaami lak ayo duulip namti, kii maaklo ke-lokomip disa. Kii talalu-yimuliya, suunkup ilokomip o, kala-lomda, ami man yaan maak kaali, numi dabaayila talse no. God ayo, Nimi man ali dabaali daak tawaal diim kaami unang so, tunum so, imi bokoya-lomda: Itipni kukup mafak kaami kalan kaata, yim-bak-saanak o, kala-somdala, dabaala tildaak talse daa; kemin, kaa dong dokoyila tiin tap daalin tap kelin o, kala-lomda dabaala tildaak talse.



1 Jon 5:11-13

God ami weng kanum bokosa kaami weng tituun-kup tabin kaali kalabuu. Kemin, God ami aket kaali ti, Suunkup ilin unang tunum kelin o kala-lomdala, ami Man ayo dabaala tal as diim taan-ilomdaya, numi iliim uyo bolaya, nuli kawu tiltam almi suunkup ilin unang tunum ke-sulup. Kemin, kawanita God ami Man ayo, kiimi diim kawu bom-balala, ilip namti, kiita suunkup ilin unang tunum kebip namti kaa bom-bilip ale, kawanita God ami Man ayo, imi diim kawu, bom-balala ilin disa kelip namti, kiili suunkup ilin unang tunum ili kaa bom-bilip disa. God ami Man Yesus ami lak duulin kipyo! Nali sukun kalawaali dola kuyiliya utamipya yi, Fan nuli suunkup ilin unang tunum ke-sulup o kalin o kala dola kuyi ko.



Jon 14; 2 Korin 5; Revelesin 4, 21, 22

Storyline by: Edward D. Hughes

Illustrated by: Lazarus
and Alastair Paterson

Adapted by: Sarah S.

Tifal (tif) © 1999, Wycliffe Bible Translators, Inc.
All rights reserved.

<https://www.bible.com/bible/1647/MAT.1.TIF>

©2026 Bible for Children, Inc.

www.M1914.org

www.bibleforchildren.org

