

# **Mmofra Bible**

**ɛda (nhoma yi) adi**

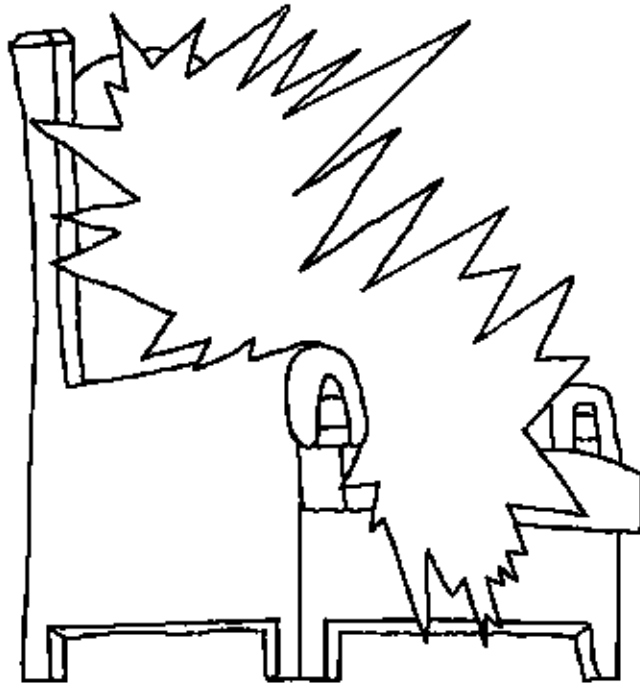

**Soro Ahenni,  
Onyankopɔn  
fie aye fe**



**(Nnipa no din) na ɔkyerɛw nhoma yi:  
Edward Hughes  
... na ɛyɛɛ mfonɪ yi: Lazarus  
... na ɛdandan nsem yi: Sarah S.  
... na kyereɛ aseɛ kɔɔ ... : Christian Lingua  
... na wɔyɛ nhoma yi: Bible for Children  
[www.M1914.org](http://www.M1914.org)**

**BFC  
PO Box 3  
Winnipeg, MB R3C 2G1  
Canada**

**©2018 Bible for Children, Inc.  
Tumi krataa: Wowɔ hokwan sɛ woyɛ nhoma yi photocopy  
anaase wotintim nhoma yi, bere tenten a wontɔn.**



**Bere a na Yesu wɔ asase so no, Ɔka soro Ahenni ho  
asɛm ɛkyerɛɛ n'asuafo no. Na ɔfrɛ ɔsoro “m'Agya fie”  
a tenaberɛ pii wɔ hɔ (ofie kɛse).**

**Ofie kɛse yɛ ofie a ɛso na ɛyɛ  
fɛ. Nanso, soro ahenni  
no ɛso na ɛyɛ fɛ  
kyɛn ofie biara  
wɔasaase yi so.**

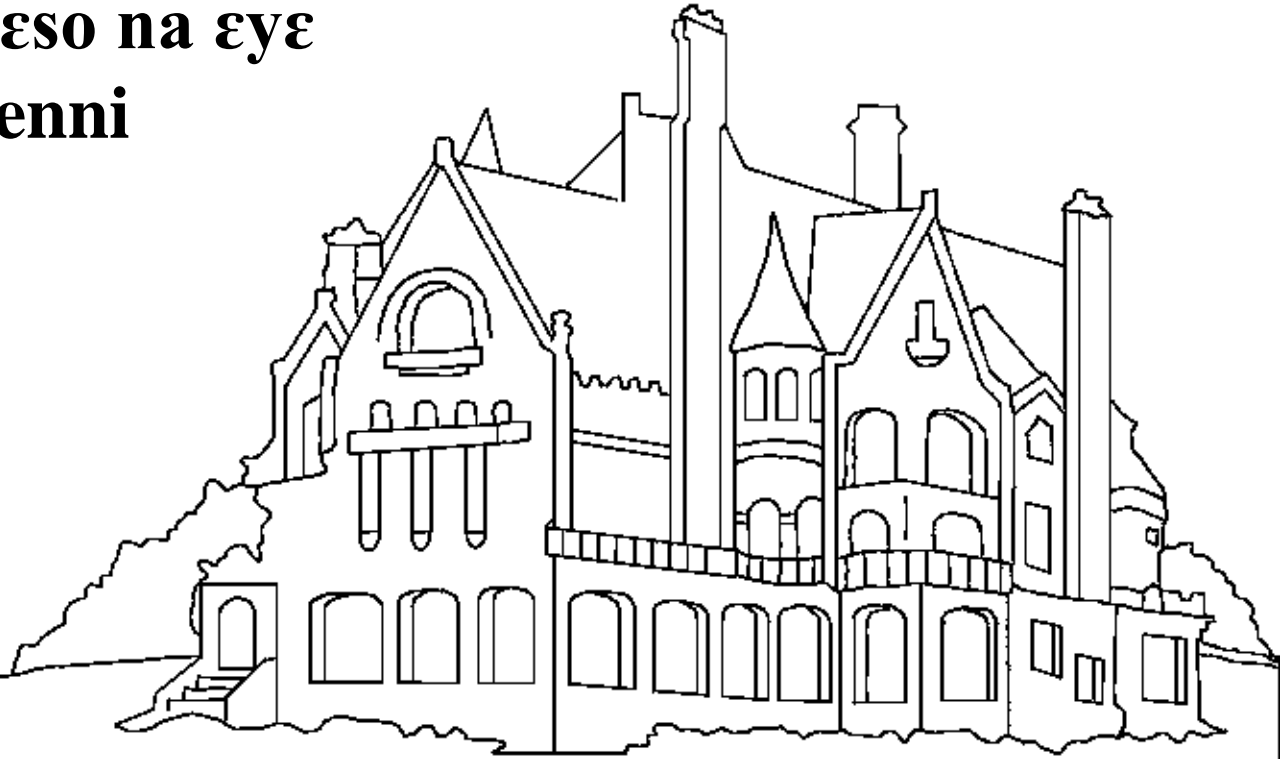

**Na Yesu se wɔn sɛ, “Merekɔ makɔsiesie baabi mama mo. Na sɛ mekɔ na mekɔsiesie baabi mema mo a, mɛba bio, na mabɛfa mo makɔ me ara me nkyɛn.” Ne wusɔre akɔyi no, Yesu kɔɔ soro. Bere a na n’asuafo no binom rehwe Yesu no, wɔmaa no so, na mununkum gyee no firii wɔn anim.**

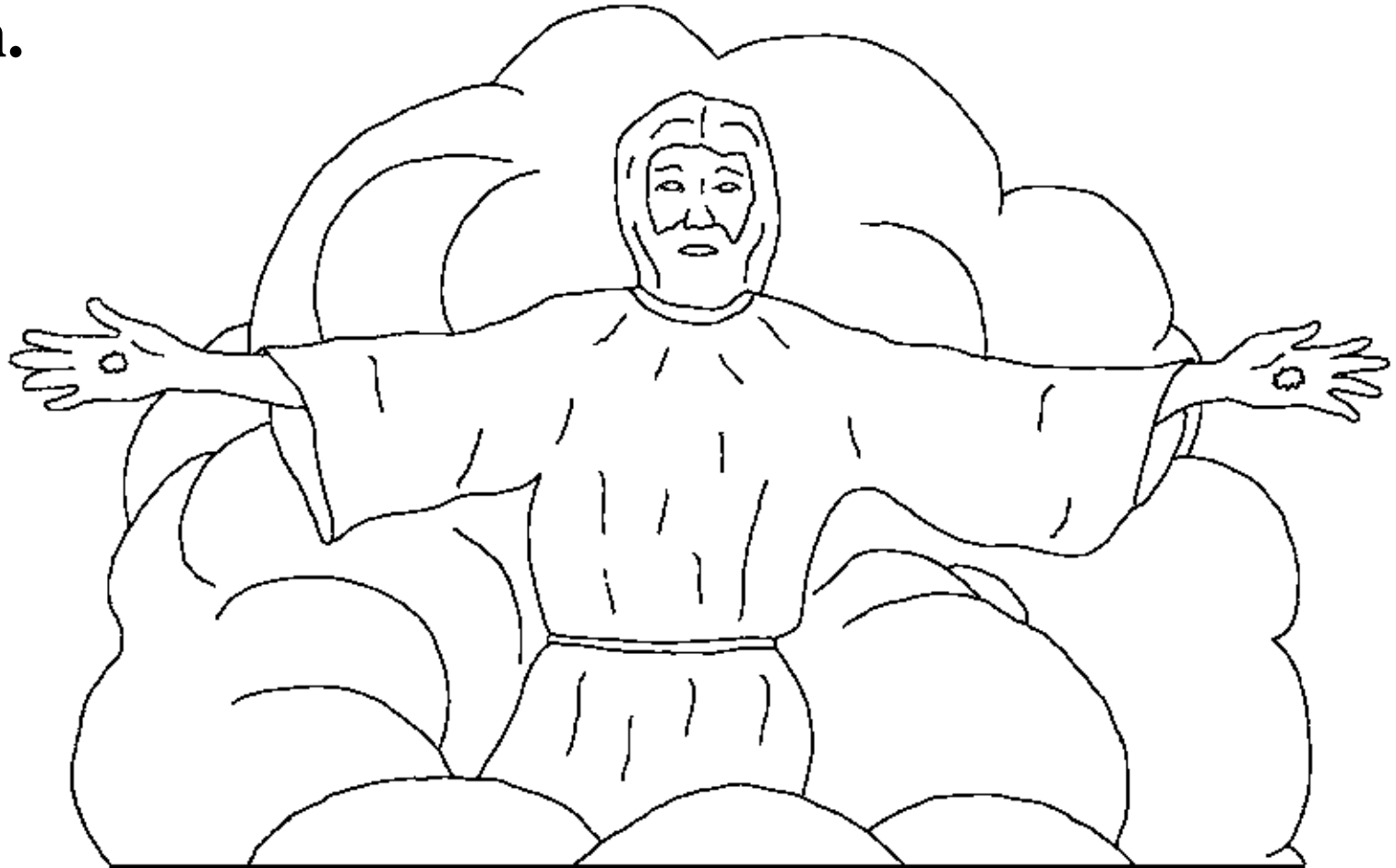

**Efri saa bere no, Kristofo εκαε Yesu bɔhyεε no,  
na wɔhwε ne kwan. Yesu kaa sε ɔβεsan aba mpofirimu,  
bere a a yεnhwε kwan. Na Kristofo a wɔbewu  
ansa na Yesu mmaεε a εtɔ so Mmienu no  
nso ε? Bible no kyerε sε wɔkɔ Yesu  
nkyεn tee. Na εyε yεn fε mmom  
sε yεβεfiri nipadua mu  
fie ha akɔtena efie wɔ  
Awurade nkyεn.**

**yε ne Awurade  
na εwɔ hɔ**



**Bible nhoma a etwa to, Adiyisem no kyere senea  
Ahenni mu ho beye anigyee. Deɛ ema no ye anigyee  
no ne se, asoro ye Onyankopon fie. Onyankopon wo wo  
baabiara, nanso  
nahengua no  
wo soro.**

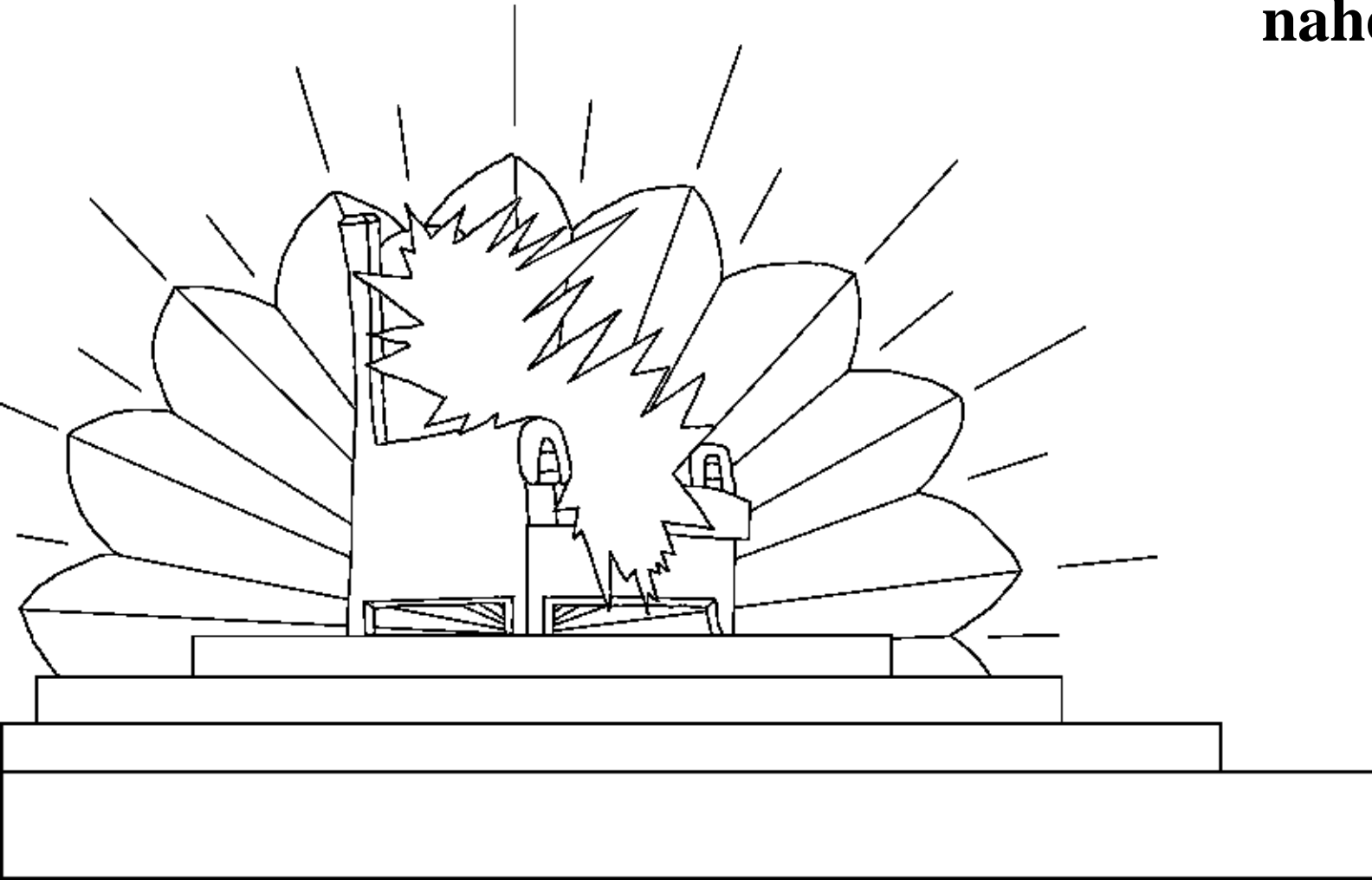

**Abɔfo ne nnipa a wɔwɔ soro ekoto  
sɔre Onyankopɔn. So Onyankopɔn  
mma nyinaa a wɔawuwu no wɔ  
soro ahenni no mu anaa?  
Wɔbom de nne to nnwom  
eyi Onyankopɔn ayɛ.**

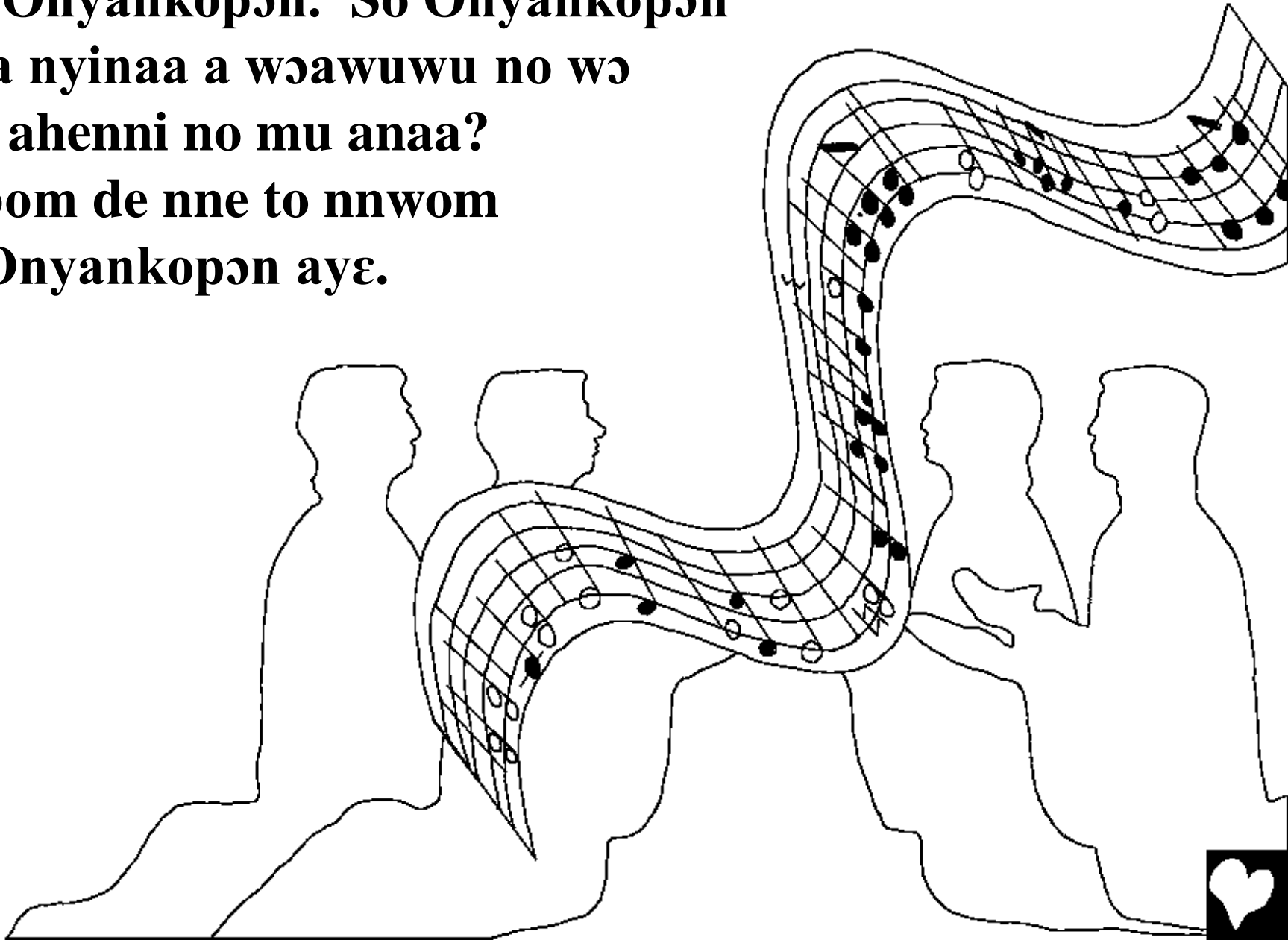

**Yei ne nsem a ewo nnwom foforo a woto: WOFATA  
SE WOGYE AYEYIE, EFIRI SE WOKAKU WO,  
NA WODE WO MOGYA ATO  
YEN AMA ONYANKOPON,  
AFIRI MMUSUA NE OKASA NE  
NKURUFOO NE AMAN NYINAA  
MU ABA ONYANKOPON  
NKYEN.**

**(Adiyisem 5:9)**

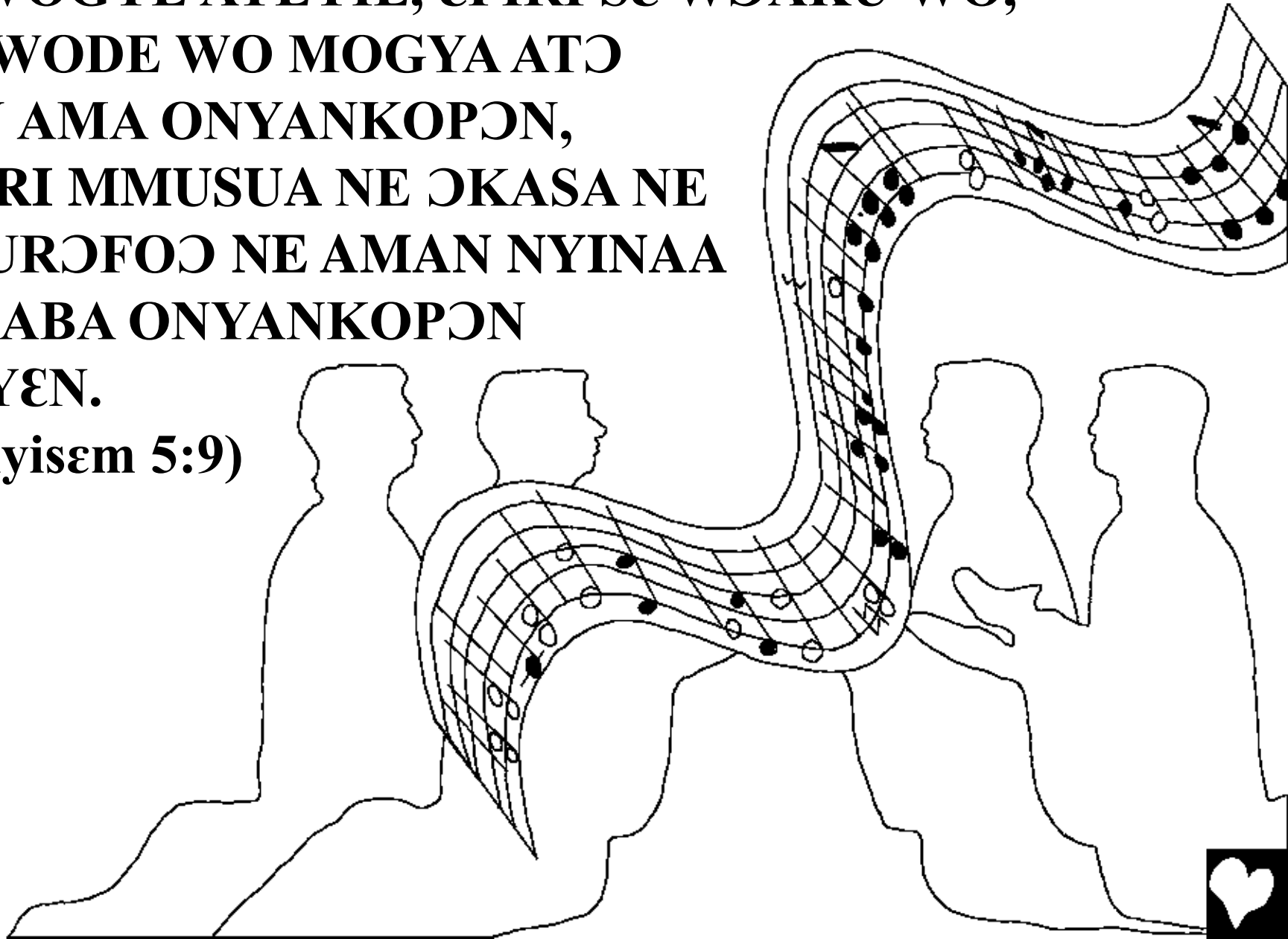



**Nkratafa a etwa to wɔ Bible no mu no ɛdi soro ahenni  
ho no ɛtoto “Yerusalem foforo no”. Kuro no so paa, na  
wɔato afasuo atenten atwa ho ahyia. Wɔdi ahwehwɛbo  
na ato afasuo no. Wɔdi agude a ɛsom bo ne aboɔden boɔ  
a ɛhyeren na ato ɔfasuo no fapem. Apono no mu**

**biara  
wɔde  
ahwene  
pa baako  
na ɛyɛɛ.**

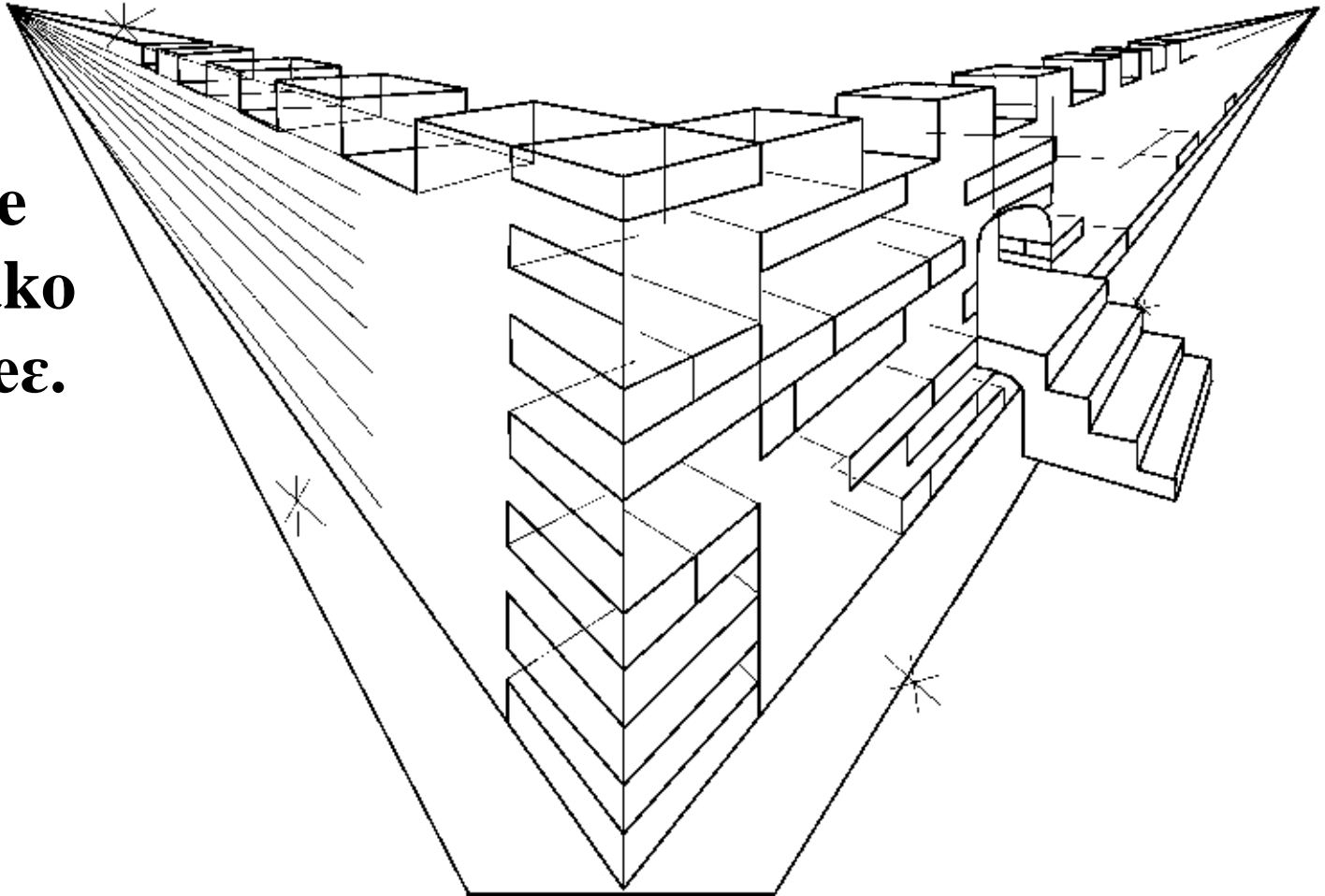

**Na apono no ye nhwene pa a yennto mu. Momma yenko  
nko hwe senea eho tee... WOW! asoro ahenni mu ye fe  
paa. na kuro no ye sika kronkron te se ahwehwe  
kronkron. Na kuro no abontene ye sika kronkron.**

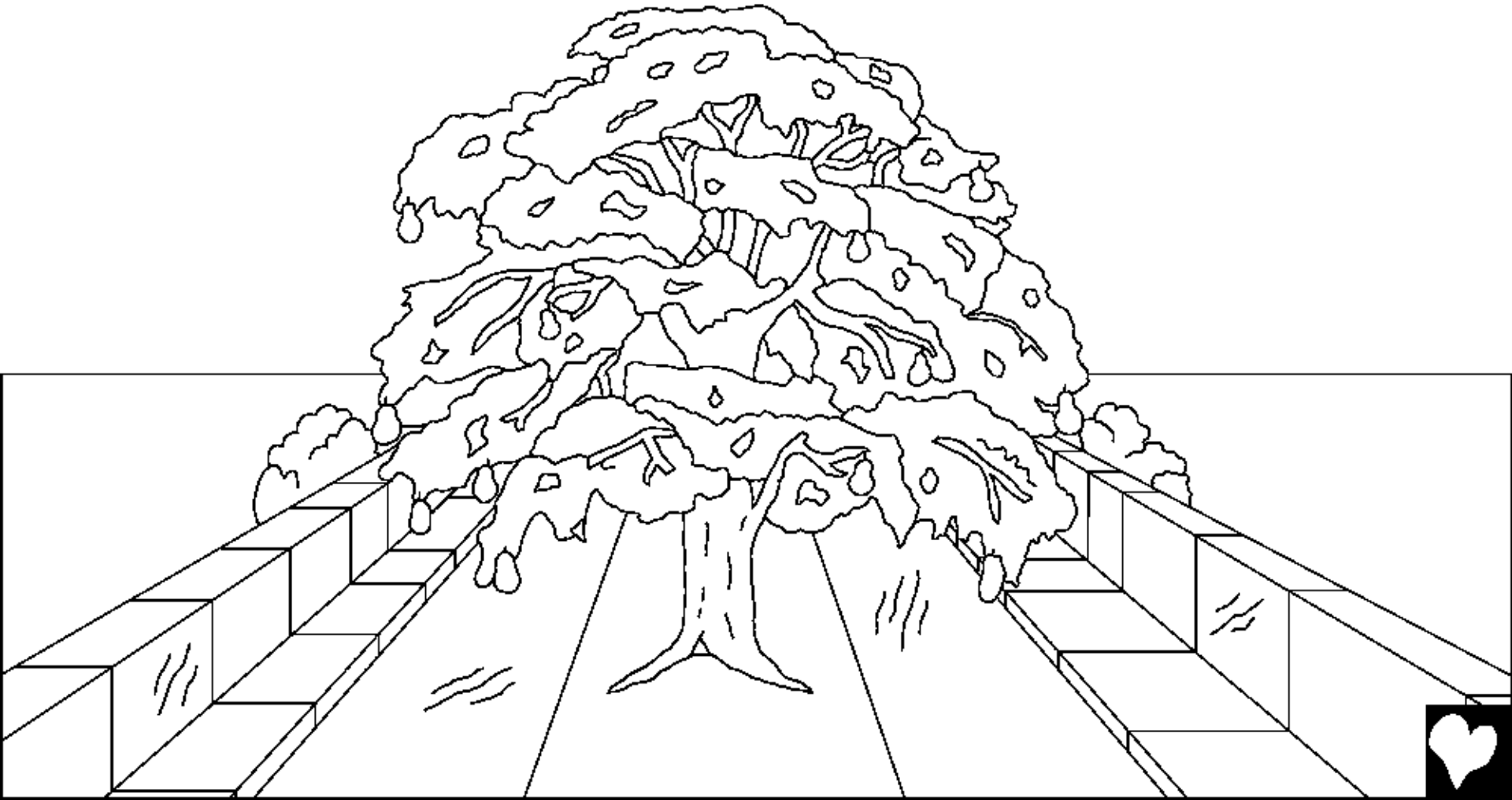

**Na nkwa nsuo asubɔnten a ani tee se ahwehwe efiri  
Nyankopɔn ne Adwammaa no ahennwa no mu. Na  
asubɔntene no afanu nyinaa no na nkwa dua sisi ho, de  
na esi Eden turo. edua yi ye soronko. Na eso aba ahodo  
dummienu, na esoso n'aba bosome biara. Na dua no  
ahahan na wɔde sa amanaman no yadee.**

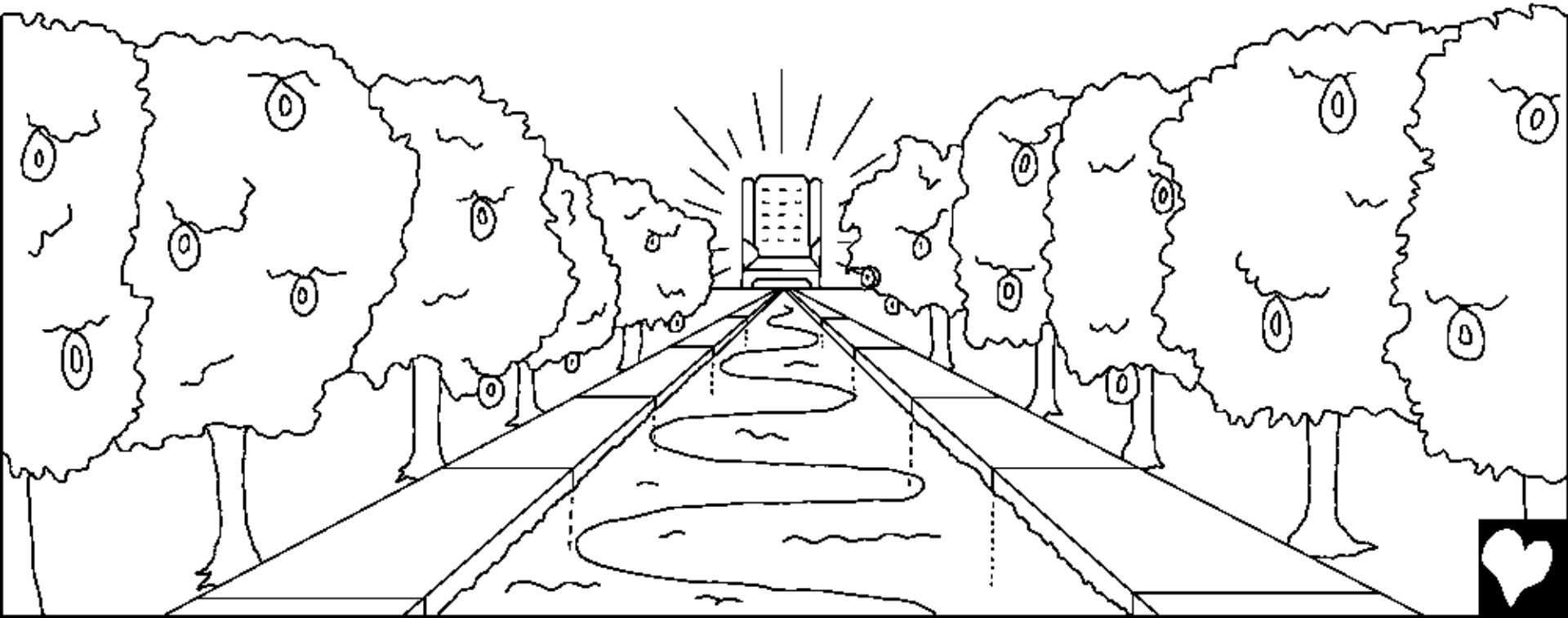

**Na enhia se owia anaa ɔsrane beɔpae wɔ kuro no mu.  
ɛfiri se Nyankopɔn animuonyam hyeren wɔ mu. Na  
anadwo biara nni hɔ.**

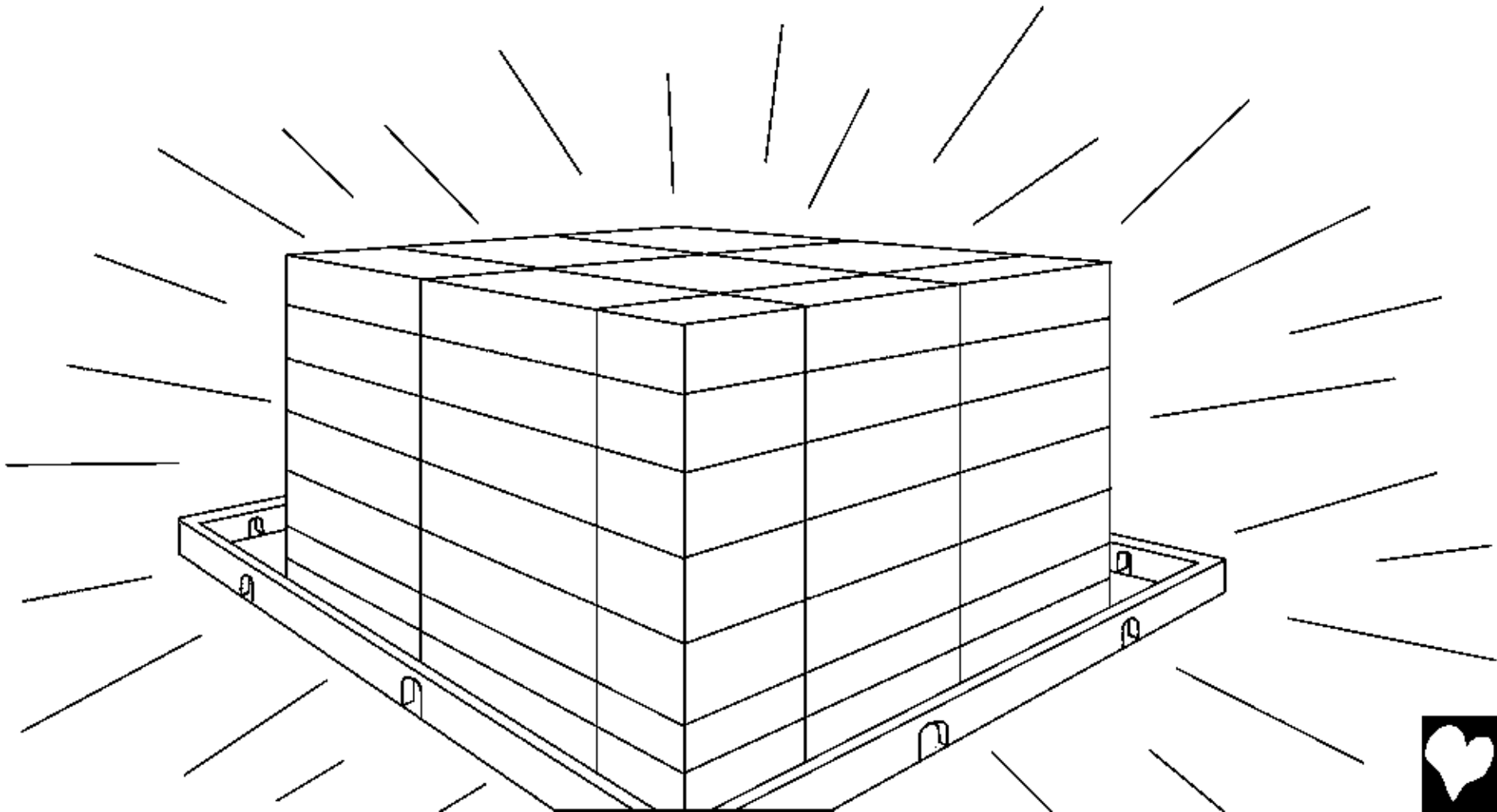

**Μπο, μμοα α ρωρ soro ahenni hε egu ahorow pii. Wεye  
μμοα α wαdwudwo na wεpe agorα. Mpataku ne nguan  
εwe nwura εbom. Na gyata bεwe εsrε te σε nantwinini.  
Wεrempira, na wεrensεe adeε bio, wα me bepα kronkron  
no nyinaa so, **AWURADE** na ρσεε.**

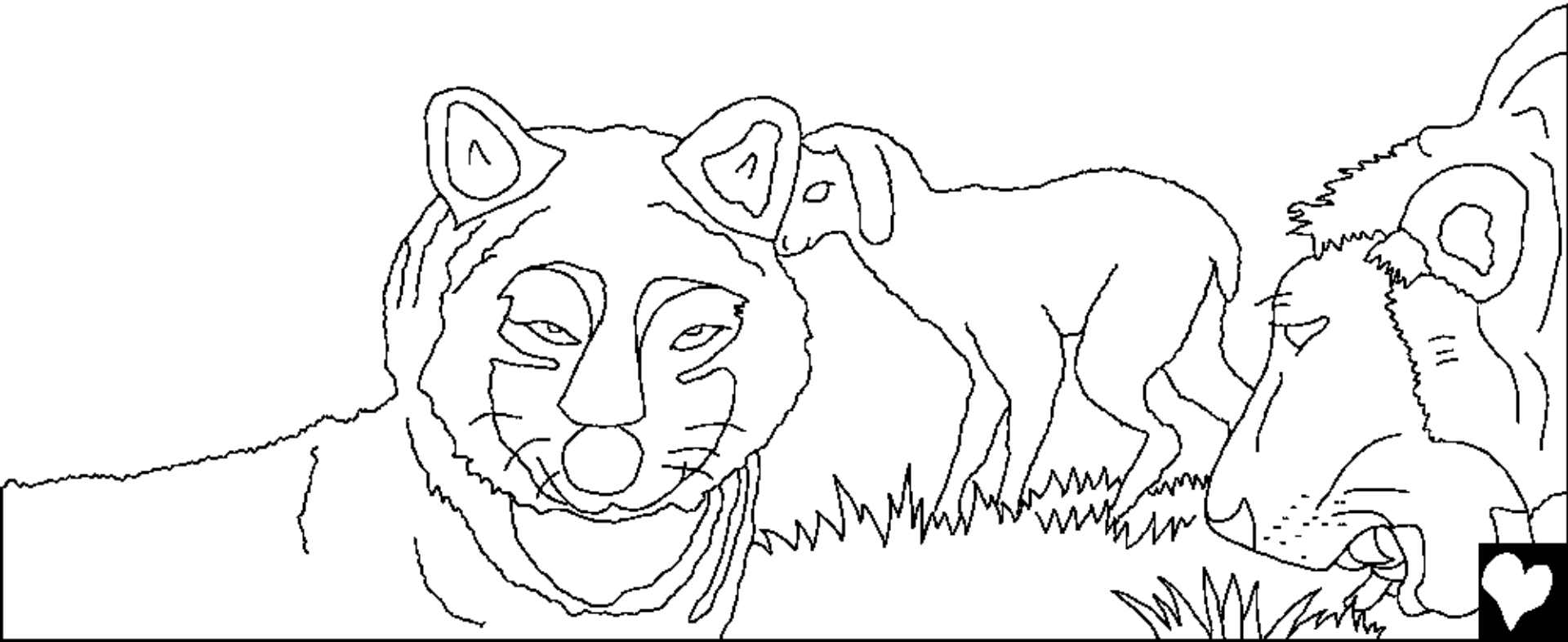

**Se ye hwe a, nneema bi a ewo soro nni asaase yi so. Atem didie nni ho. Ako ne pesemenkominya nni ho. Apon a wototo mu nni ho, esiane se awifo nni osoro Ahenni ho.**

**Atrofo, awudifo,  
abayifo, anaa  
atrimdimfo  
nni ho.**

**Bone  
biara  
nni  
osoro  
Ahenni ho.**



**Nyankopɔn nti, ɛsu  
nni ɔsoro Ahenni hɔ.  
Et ɛyaw Da a, Nyame  
mma esu esiane ɛyaw  
a ɛyɔ wiase yi mu.  
Nyankopɔn beyi esu  
afi soro ahenni.**



**Owuo nni ɔsoro Ahenni hɔ. Nyankopɔn mma ne Aurade  
no bɛtena ase daa. Awerɛhow nni hɔ bio, ɛsu nni hɔ bio,  
ɛyaw nni hɔ bio. ɔyare nni hɔ bio, apontow nni hɔ bio,  
Wɔrenye ayi na wɔrensi  
pɛ bio. Obiara a ɔwɔ  
soro Ahenni hɔ no  
ɛne Nyankopɔn  
ani begye.**





**Nea ehia sen ne nyinaa no, ɔsoro Ahenni  
yɛ mmerantewaa ne mmaayewaa  
(ne mpanyimfo) a wɔde wɔn werɛ  
ahyɛ Awurade Yesu Kristo mu  
no sɛ wɔn Gyefo, na w'ayɛ  
osetie ama No sɛ  
wɔn Wura.**

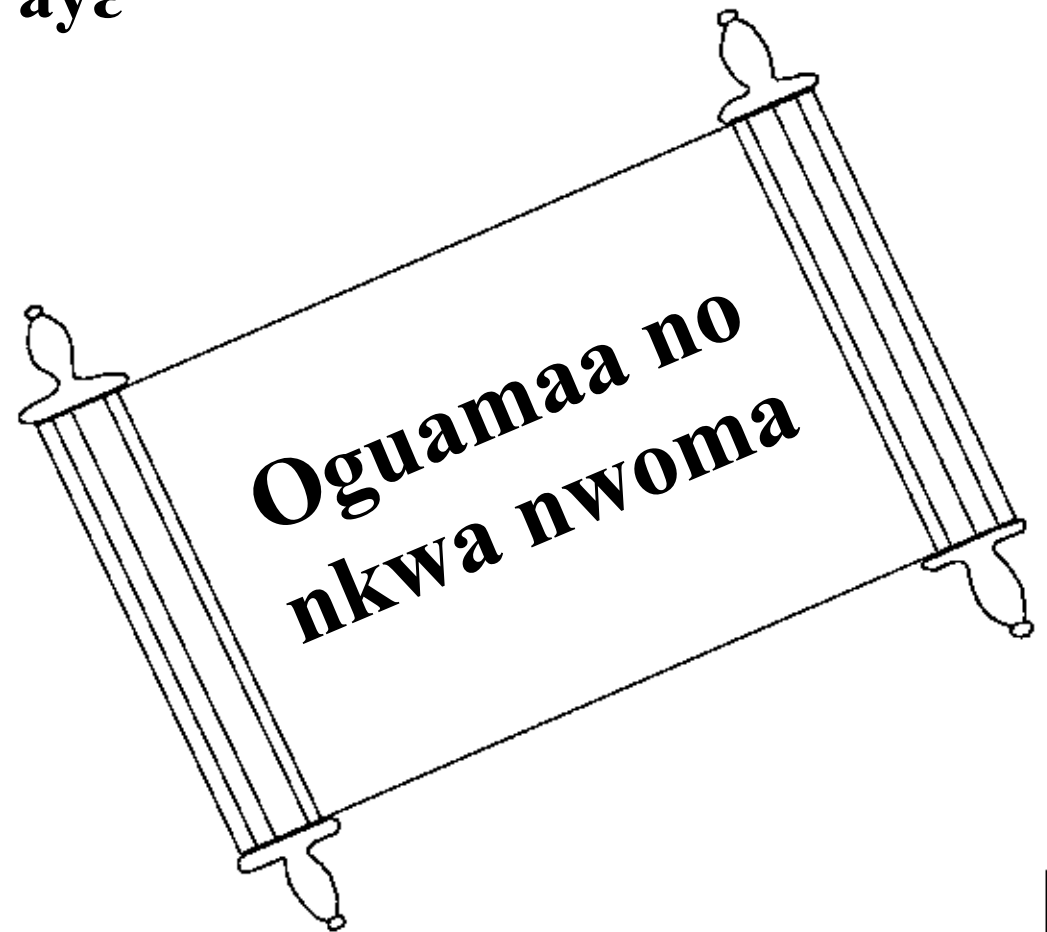

**Nwoma bi a εωϑ ϑsoro Ahenni a  
yεfrε no Oguamaa no nkwa nwoma.  
Nnipa din ahyε saa nwoma yi mu  
ma. So wunim wϑn a wϑakyerεw  
wϑn din wϑ saa nkwa nwoma yi  
mu? Wϑn a wϑde wϑn werε hyε  
Awurade Yesu Kristo  
mu no. So wo  
din wϑ hϑ bi?**

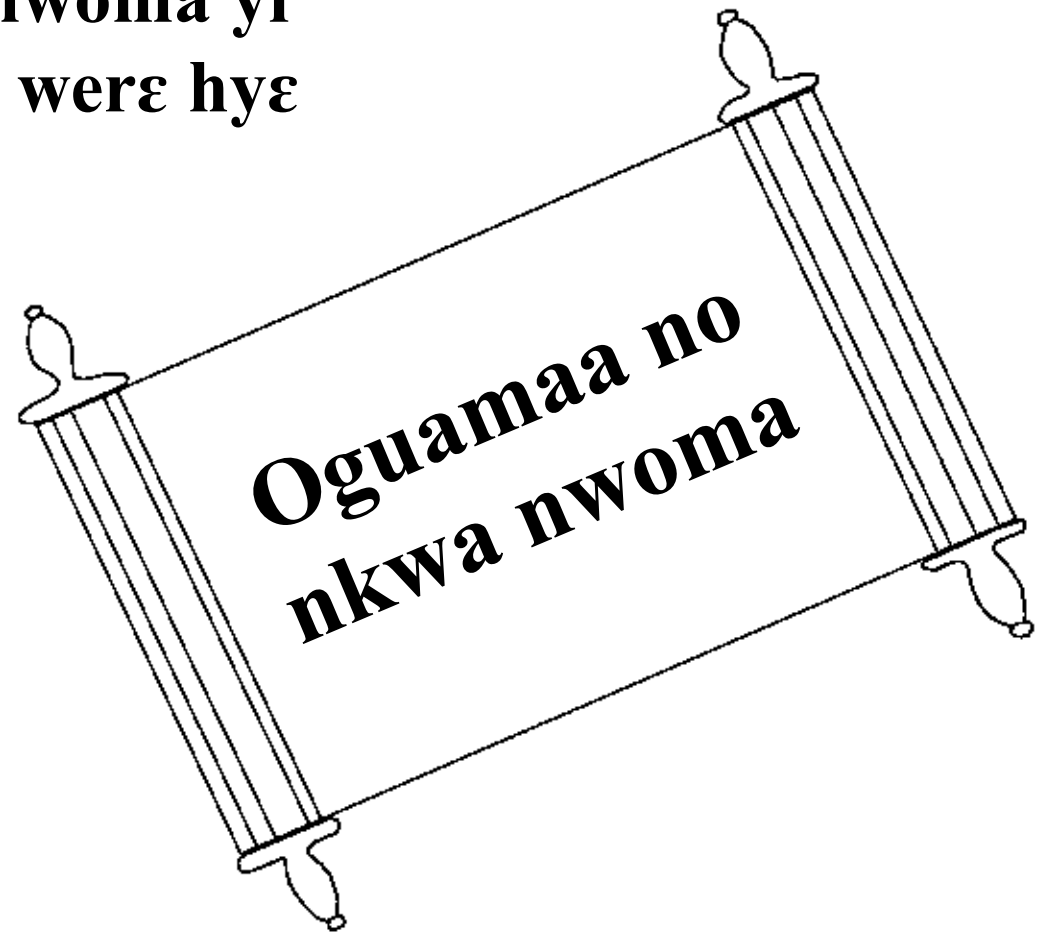

**Nsem a edi akhiri wɔ Bible no mu efa ɔsoro  
Ahenni no ye ɔfre a eye nwonwa. “Honhom no ne  
ayeforo no kɔ so ara ka se: ‘Bra!’ Ma nea ɔwɔ aso  
no nka se ‘Bra!’ Ma nea sukɔm de no ɔmmra.  
Nea ɔpe no mmegye nkwa nsu no kwa.”**

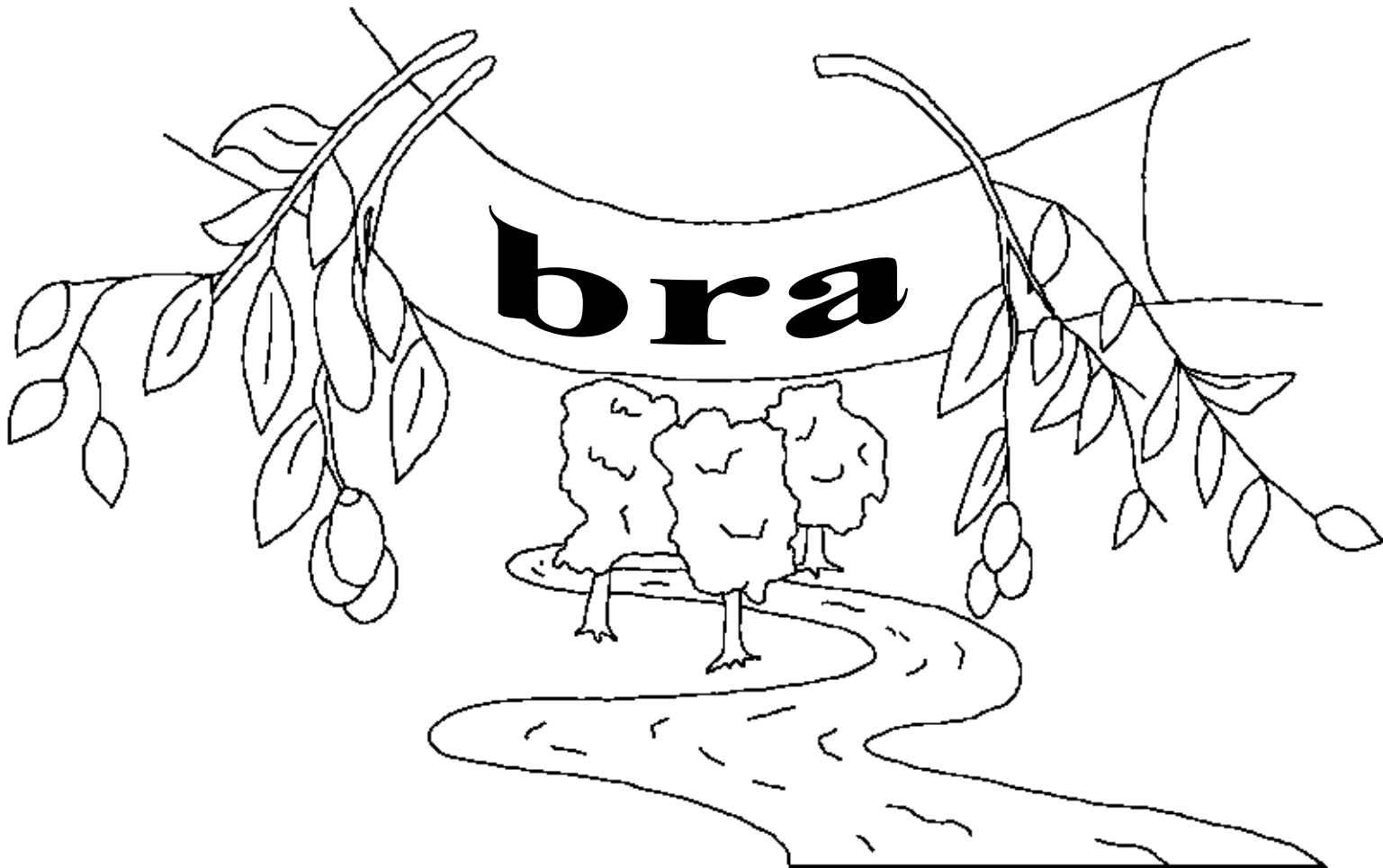

**Soro Ahenni, Onyankopɔn fie aye fe**

**Abakɔsem a efri Nayame asem mu, a eye Bible no**

**a ewɔ**

**Yohanne 14; 2 Korintofo 5;  
Adiyisem 4, 21, 22**

**“Wo nsem mu bue ma hann.”**

**Nnwom 119:130**



**Awieε**



**Bible yi mu asem eka yen Nyankopon nwonwafo no ho asem,  
nea oboo yen na ope se yehu no yie.**

**Nyankopon nim se y'aye boni bebre. Bone akatua  
ne owuo nanso enam odo kesea a owo ma ne mma nti,  
osomaa ne do ba a owoo koro no, Yesu, se ommewu wo asendua  
no so ema yen bone. Yesu, soree firi awufo mu, ena oko soro.  
obeba aba tena wo mu, na wo ne no atena ase daa. Na se wogye  
Yesu di, na se wosre ne ho bonefakye a, wode bekye wo!  
Wobeba abetena wo mu, na wo ne nu atena daa daa.**

**Se wo gyi di se nsem yi ye nokware a, ka nsem yi kyere Onyakopon:  
Awurade Yesu, megye di se woye Onyankopon, na wofaa akooa  
tebea etoo ho so, me bone nti, na wotease daa. Mesre wo se bra  
m'abrabo mu na fa me bone kye me, na me nya nkwa foforo, na  
daakye bi me ne wo atena ase daa. Boa me na me nye osetie  
mma wo na me ntena ase mma wo se wo ba. Amen**

**Kekan Bible no na ene Onyankopon nkasa da biara! Yohane 3:16**

