

# Bolalar Muqaddas Kitobi

## Tasvirlab beradi

Shomuil,  
Hudoning  
hizmatkori



...tomonidan yozilgan: Edward Hughes

...tomonidan ilustrasiya qilingan:

Janie Forest; Alastair Paterson

...tomonidan o'zgartirishlar kiritilgan:

Lyn Doerksen

...tomonidan ishlab chiqarilgan: Bible for Children

[www.M1914.org](http://www.M1914.org)

BFC

PO Box 3

Winnipeg, MB R3C 2G1

Canada

©2021 Bible for Children, Inc.

Lisenziya: Bu hikoyani chop etishingiz yoki nusha ko'chirishingiz mumkin.

Lekin u sotilmaydi.



Hanna juda yahshi ayol bo'lib, Elqana ismli odamning hotini edi. Ularning ikkovi ham hudojo'y bo'lib, odamlarga yahshilik qilib yurishardi. Lekin Hannaning hayotida bir narsa yetishmas edi.

Hanna befarzand edi. U Xudodan farzand so'rab duo qilar va farzandli bo'lishni juda istardi.

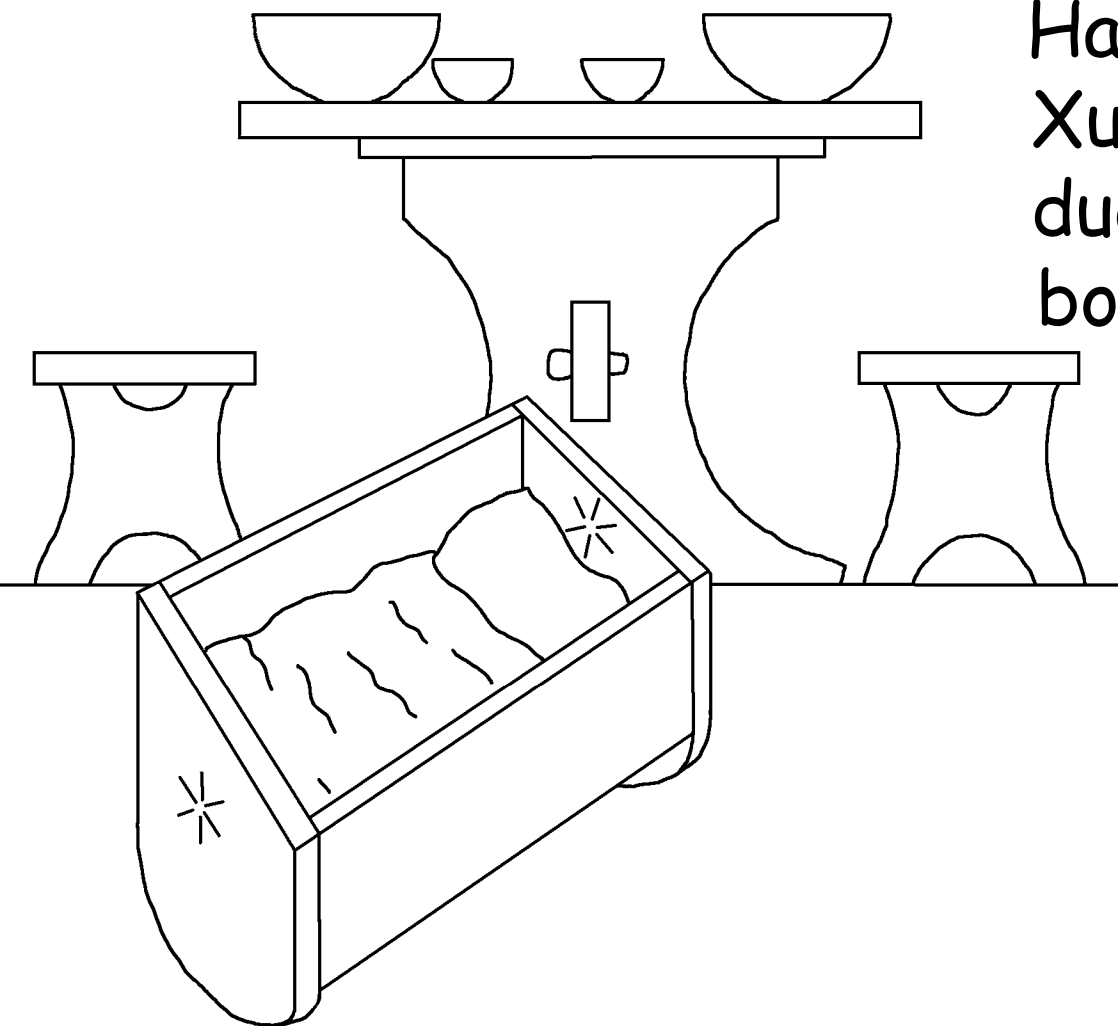



Hanna har yili  
Sarvari Olamga  
sajda qilib, qurbonlik  
keltirar edi. Bir kuni  
u: "Agar menga o'g'il  
ato etsang, o'sha  
o'g'limni Sening  
xizmatingga  
berardim," - deb  
Xudovandga  
va'da berdi.





Ruhoniy Elah  
Hannaning ibodatiga  
qarab turar edi.  
Hanna ichida gapirar,  
ovozi eshitilmas, faqat  
lablari qimirlardi.  
Shuning uchun  
Ellah Hannani  
mast bo'lsa  
kerak deb  
o'yladi va  
uni koyidi.





Ammo  
Hannah Ellahga:  
"Yo'q men sharob  
ichmaganman, faqat  
yuragimdagini Egamga  
to'kib solyapman," - dedi.  
Shunda Ellah: "Eson-omon  
bor. Isroil halqining Xudosi  
tilagingni bajo keltirsin," -  
dedi. Shunda Hanna umid  
bilan uyiga qaytdi.



So'ng tez orada Hannaning yuragi quvonchga to'ldi. Xudovand Hannaga marhamat qildi. Hanna homilador bo'lib, o'g'il tug'di va uni Egamizdan tilab oldim deb, ismini Shomuil qo'ydi. Hanna Xudoga bergan va'dasini unutmadimikan?

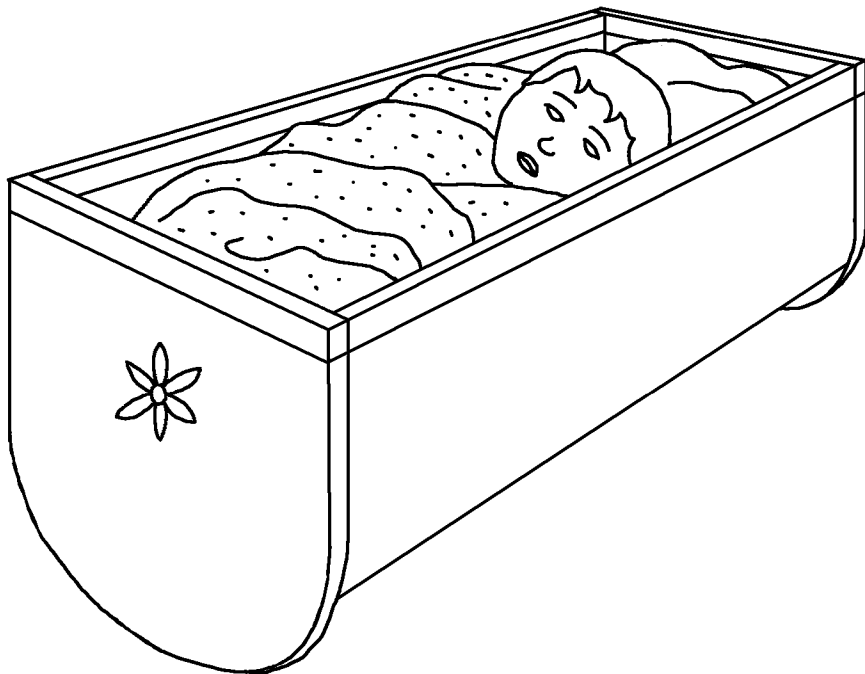

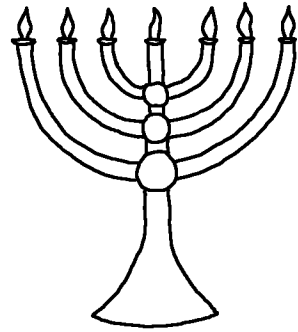

Hanna qurbongohga ancha vaqt bormadi. Nahotki u Xudoga bergan vadasini buzdi? Albatta yo'q! U Shomuil katta bo'lishini kutardi. Shomuil katta bo'lgandan keyin Hanna uni Xudoga xizmat qilish uchun ruhoniy Elahning yoniga olib bordi.







Xudovand Hannaga  
ko'p marhamat  
ko'rsatdi.

Shomuidan  
keyin, Xudovand  
unga yana 3 o'g'il  
va 3 qiz berdi.  
Hanna har yilgi  
qurbonlikni ato  
etish uchun  
Xudoning huzuriga  
kelib, o'zi tikkan  
kiyimni o'g'luga  
olib kelardi.



Shomuil ruhoniyl Elah huzurida qolib, Hudoga hizmat qilardi. Ellahning o'g'illari Ho'fnah va Finhaz ham otalari bilan birga hizmat qilishar edi.



Lekin ular yaramas yigitlar bo'lib,  
Egamizni hurmat qilmas va  
ruhoniylk burchlarini mensimas  
edilar. Ular hatto otasi ham quloq  
solmas edi. Ruhoniy Ellah  
o'g'illarini ruhoniylk vazifasidan  
bo'shatishi kerak edi,  
ammo u  
bunday qilmadi.



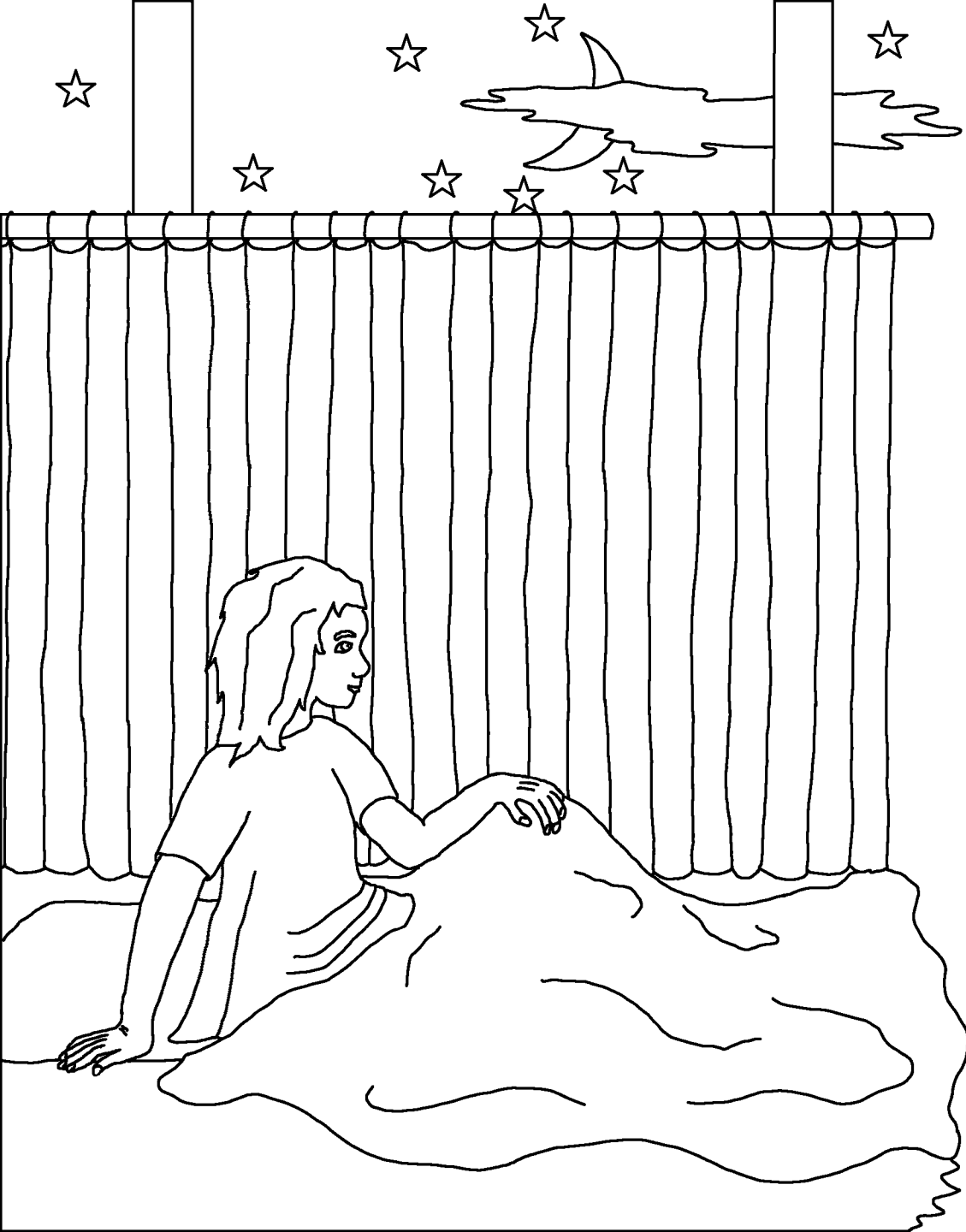

Bir kuni kechasi  
Xudo Shomuilni  
chaqirib qoldi.  
Shomuil: "Labbay  
hazratim ," - deb,  
Ellahning oldiga  
yugurib keldi. Bu  
hodisa 3 marta  
sodir bo'ldi,  
shunda Ellah  
bildiki, o'spirinni  
Xudovand  
chaqirayotgan  
ekan.



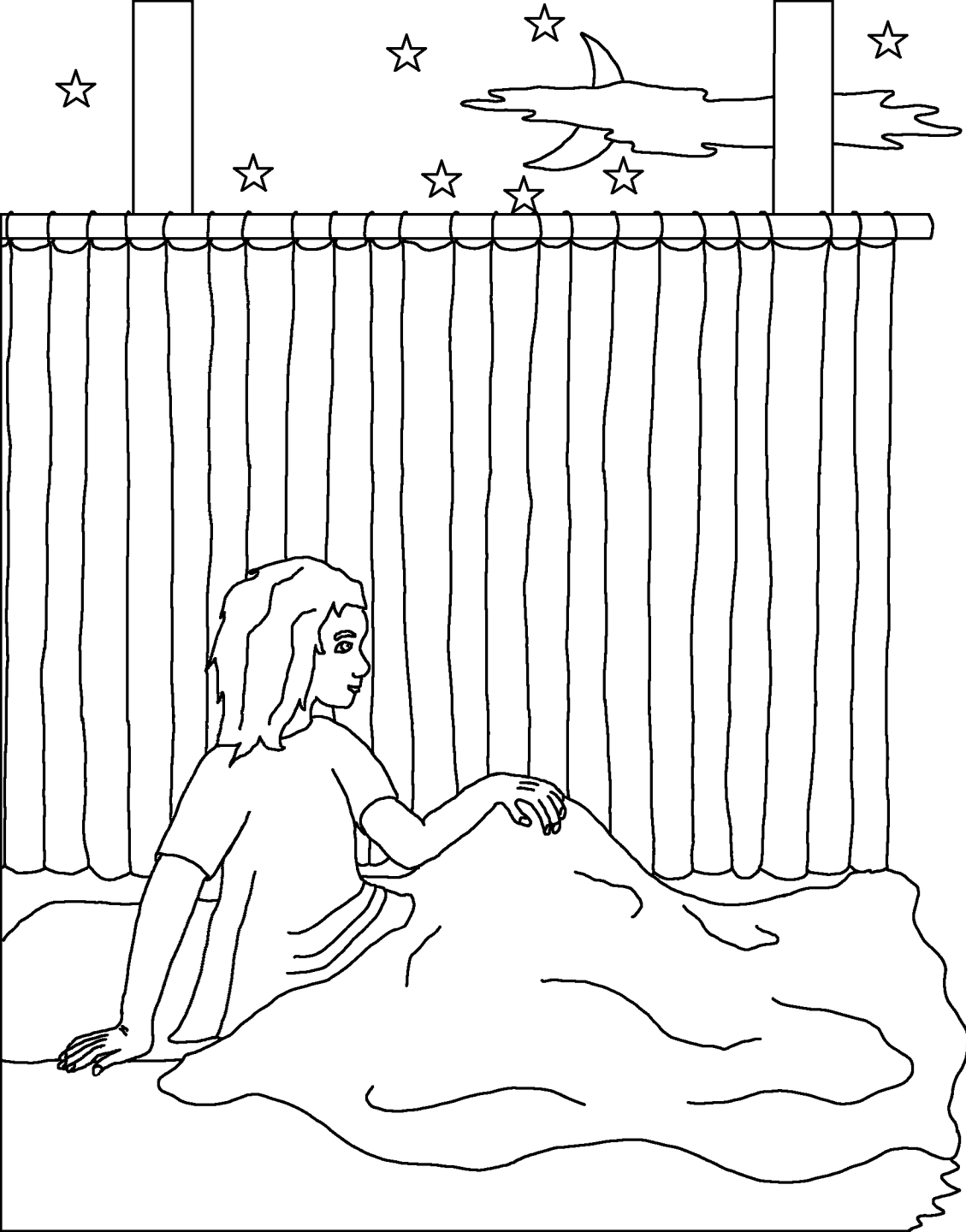

Shunda Ellah  
Shomuilga dedi:  
"Agar o'sha ovoz  
seni yana chaqirsa,  
gapiraver Egam,  
xizmatching  
eshitadi, degin".  
Xudovand o'sha  
yerda Shomuilga  
yana zohir bo'lib,  
unga muhim  
habarni  
berdi.



Ertalab Ruhoniy Ellah Shomuilni chaqirib:  
"Egamiz senga nimalar dedi?" - deb so'radi. Shomuil  
Ellahdan hech narsani yashirmay aytib berdi. Bu juda  
qo'rqinchli habar edi. Chunki Xudovand uning  
o'q'illari Ho'fnah va Fihnazni o'ldirishga qaror qilgandi.



Xudoning aytgan so'zlari bajo bo'ldi. Shundan so'ng Falastinliklar qattiq hujum qilib, Isroil lashkarlarini mag'lub etdi. Dushmanlar Xudoning Ahd Sandig'I ham qo'lga kiritishdi. Ellahning ikkala o'g'li - Ho'fnah bilan Finhaz esa halok bo'ldi. Ellah bu xabarni eshitgach, kursidan orqasi bilan yiqildi, bo'yni sinib, o'sha zahoti jon berdi.



Falastinliklar Xudoning Ahd Sandig'ini qo'lga kiritgandan keyin, bu ularga ko'p balo-qazolar keltirdi. Falastinliklar uni o'zlari sajda qiladigan, Do'g'on nomli butlari turadigan butxonaga keltirib qo'yishdi.

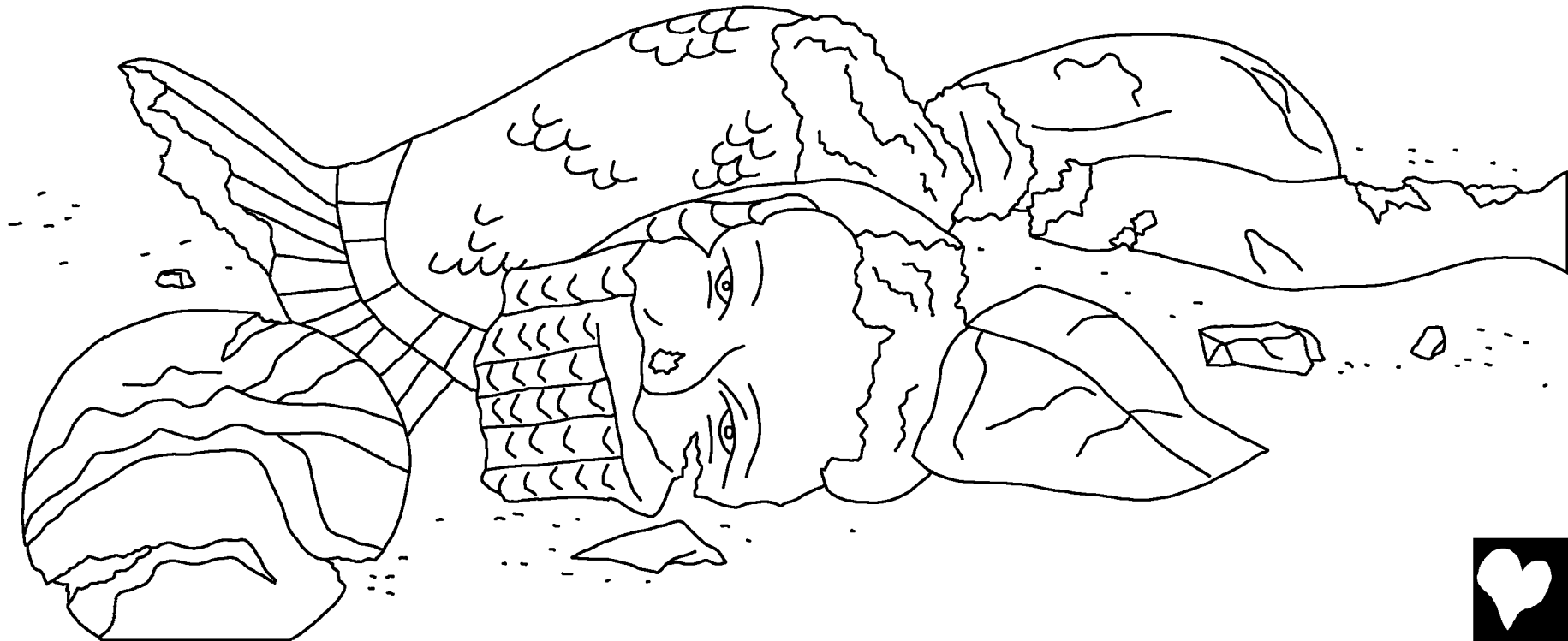



Erta sahar turib qarashsaki, Do'g'on yuzi bilan yerga ag'darilib yotgan ekan. Shunda uni ko'tarib, joyiga turg'izib qo'yishdi. Ertasiga yana turib qarashsaki, Do'g'on yerga ag'darilib yotgan ekan va bu safar uning boshi, ikki qo'li sinib, ostonada yotgan ekan.

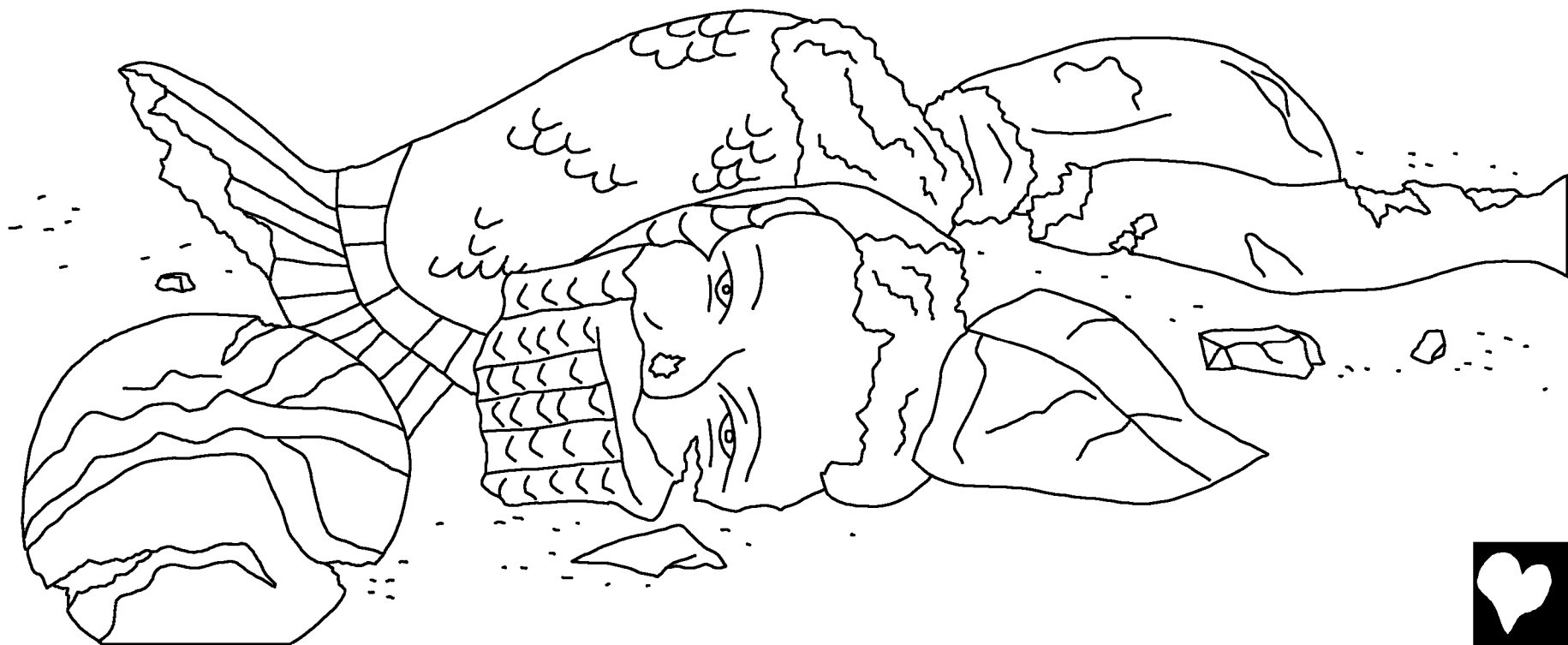



Falastinliklar kasallik bilan o'limga muhtalo bo'lishdi. Ular arava bilan sigirni qo'shib hozirlab, ichiga Ahd Sandig'ini solib, qo'yib yuborishdi. "Agar sigirlar bizning yurtimizdan o'tib, Isroil yeriga ketsa, demak boshimizga...





...bunday katta kulfatni slogan Isroil xalqining Xudosi ekanligini shundan bilib olamiz," - deyishdi. Sigirlar Isroil yeriga o'tib, to'htab qolishdi.



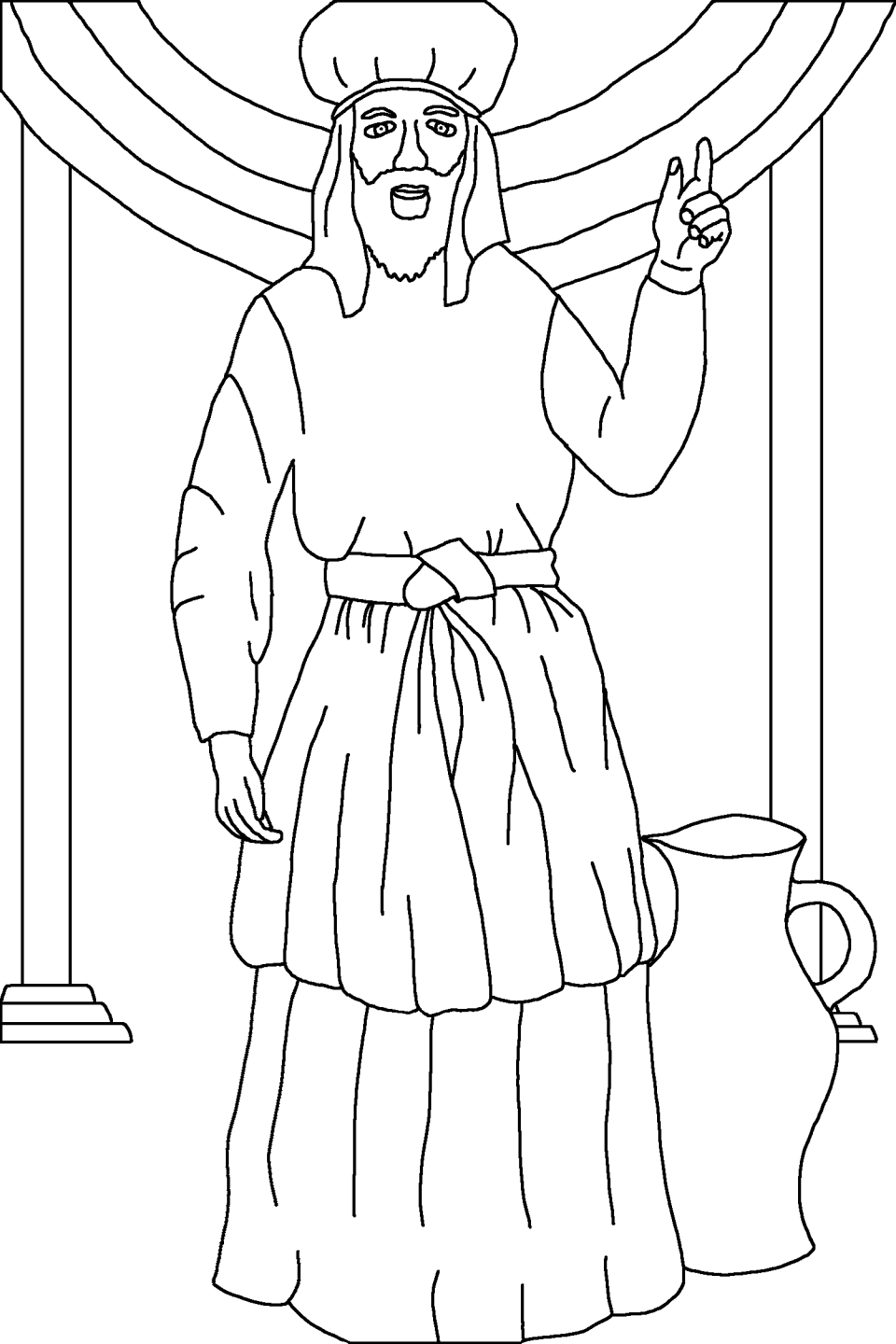

Shomuil jamiiki Isroil xalqiga: "Agar chin dildan Egamiz Xudoga qaytsangiz, Egamiz sizlarni Falastinliklar qo'ldan qutqaradi," - dedi. Isroil xalqi unga ishonib, yana Xudoga hizmat qila boshlashdi va Xudovand ularni Falastinliklar qo'ldan qutqardi.



Shomuil, Hudoning hizmatkori  
Hikoya Hudo Kalomi Injildan olingan  
...dan topilgan  
1 Samuel 1-7

"Kaloming ochilib qolganda ziyo ochar."  
Zabur 119:130



Hikoya tugadi

17

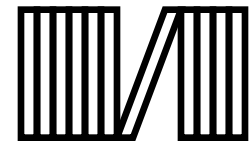

60



Bu Kalomdagi Hikoya bizlarga, Hudoning bizlarni ajoyib qilib yaratganligi haqida va biz Uni tanib bilishimiz qanchalik muhim ekanligi haqida hikoya qilib beradi.

Hudo, biz ko'p yomonliklar qilganimizni biladi va U bu Yomonliklarni gunoh deb atadi. Gunohning evazi o'lim lekin Hudo olamni shunchalik sevdiki O'zining Yagona O'g'lini berdi, va U bizning gunohlarimiz uchun hochda o'ldi. U tirilib yana Osmonga ko'tarildi. Unga ishongan kishi halok bo'lmaydi balki abadiy hayotga ega bo'ladi. Agar siz Isoga ishonsangiz, Undan gunohlaringiz uchun kechirim so'rang, U gunoharingizni kechiradi. U sizning yuragingizga kelib yashaydi va siz U bilan abadiy yashaysiz.

Agar siz bu so'zlar haqiqatligiga ishonsangiz, Hudoga shunday deb ayting:  
Qadrli Iso, Men Sening Hudoliginga ishonaman, Sen yer yuziga kelib mening gunohlarim uchun o'lding, va Sen yana hozir tiriksan va bir kuni men sen bilan abadiy bo'laman. Men hozir yangi hayot bilan yashayman, iltimos mening hayotimga kel, men Senga itoat qilishim uchun va Sening frazanding bo'lishim uchun yordam ber.

Muqaddas Kalomni o'qib Hudo bilan har kuni suhbatlashing!  
Yuhanno 3:16

