

IBhayibheli LaBantwana Likulethela

UJona
neNhlanzi
Enkulu



Ibhalwe ngu: Edward Hughes

Kwabonakala ngu: Jonathan Hay; Alastair P.

Ifanekiswe ngu: Mary-Anne S.

Itolikwe ngu: Goodwill Sithembiso Gwala

Ikhizwe ngu: Bible for Children

www.M1914.org

©2023 Bible for Children, Inc.

iLayisensi: Abantu bangazithathela noma bephrinte izinto kulendaba egunyazwe ngokomthetho kodwa akumele bazidayise.



Eminyakeni eminingi edlule, indoda
okuthiwa uJona yayihlala kwa-Israyeli.
Ngolunye usuku, uNkulunkulu
wamtshela ukuthi aye
eNineve, idolobha
elikhulu kunawo
wonke,

elinamandla
kunawo wonke
emhlabeni.

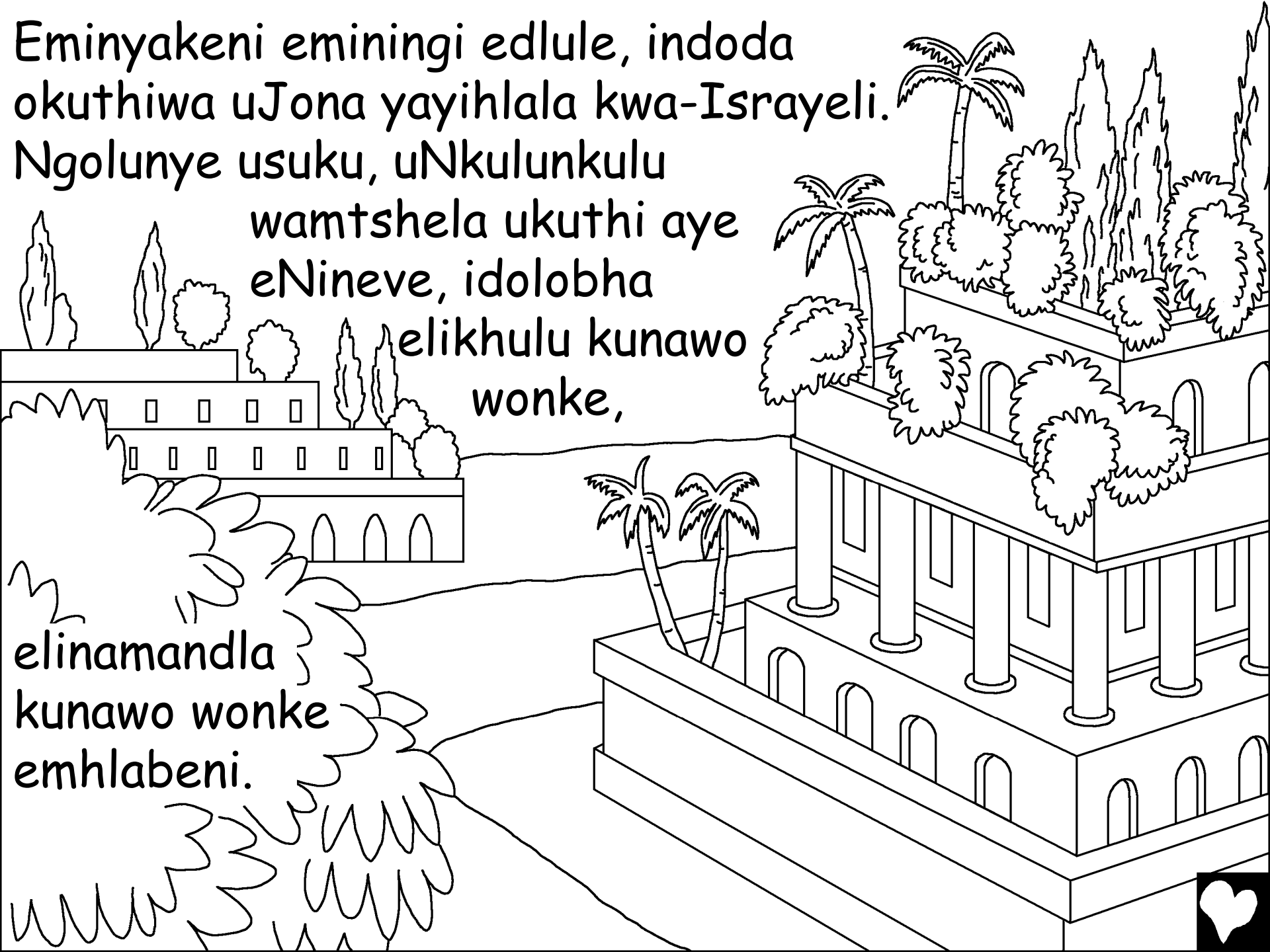

UJona kwakufanele axwayise bonke
abantu lapho ukuthi uNkulunkulu
wayebazi ukuthi bakhohlakele
kangakanani.

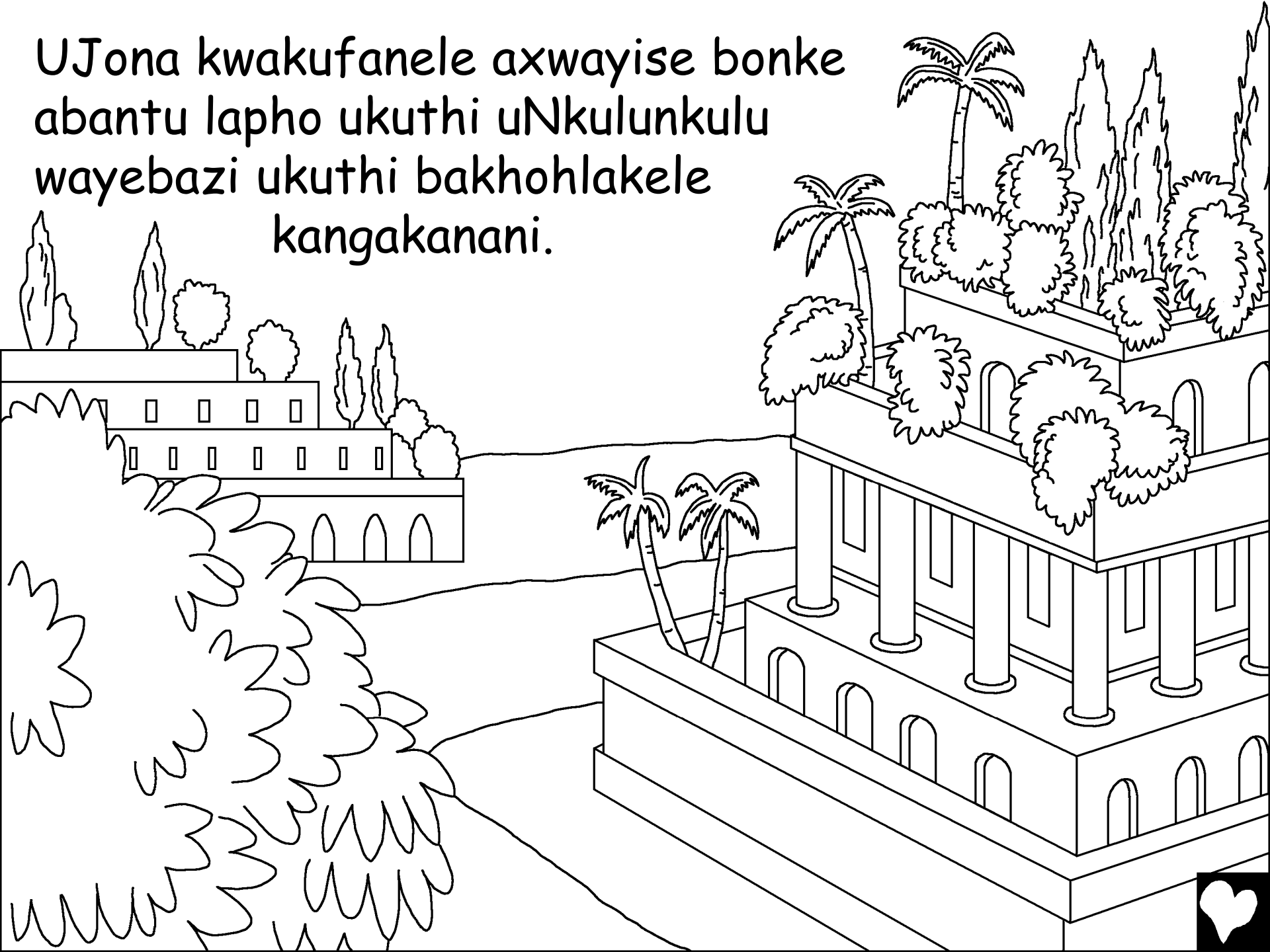

UJona akazange amlalele
uNkulunkulu! Esikhundleni
sokuya eNineve, uJona
wagibela umkhumbi wahamba
ngendlela ehlukile waya
endaweni ebizwa ngokuthi
iTharishishi.



INkosi uNkulunkulu yathumela umoya omkhulu
elwandle. Kwaba nesiphepho esikhulu! Amatilos
esaba ukuthi umkhumbi ungase uqhekeke uzike.

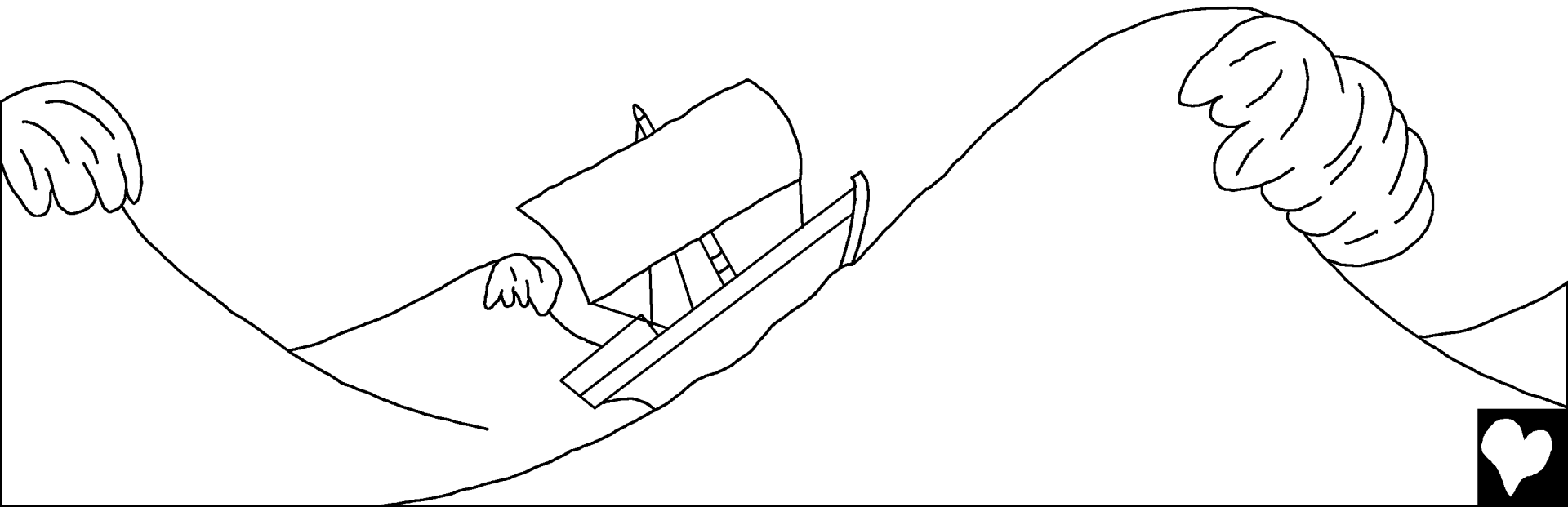

Isiphepho saba sibi kakhulu. Ethukile, amatilosi
athandaza konkulunkulu bawo futhi aphonsa yonke
impahla olwandle ukuze enze umkhumbi ube lula.
Kodwa akukho okwasiza.



UJona nguye yedwa owayengakhuleki emkhunjini.
Kunalokho, wayelele phansi emkhunjini, elele zwi.
Ukaputeni womkhumbi wamthola. "Wenzani ulele?
Sukuma! Thandaza kuNkulunkulu wakho!
Mhlawumbe uNkulunkulu angacabanga
ngathi, ukuze singabhujiswa."



Ngokushesha amatilosi anquma ukuthi inkinga yawo yayihlobene nokuthile kuJona. Wabatshela ukuthi ubalekela uJehova. Babuza bathi: "Senzeni ngawe, ukuze ulwandle luzehlise kuthina?" UJona wathi: "Ngithatheni, ningiphonse olwandle; Ngokuba ngiyazi ukuthi ngenxa yami lesi siphepho esikhulu sifikile phezu kwenu."



Amatilosu ayengafuni
ukuphonsa uJona
olwandle. Base
begwedla kanzima
ukuyisa umkhumbi
emhlabeni. Kodwa
abakwazanga.
Kwakukhona into
eyodwa kuphela!



Ngemva kokuthandazela intethelelo,
amatilosi amphakamisa uJona
amphonsa
eceleni.

Njengoba
uJona

enyamalala ngaphansi
kwamagagasi, ulwandle
lwathula futhi umoya
wanqamuka.

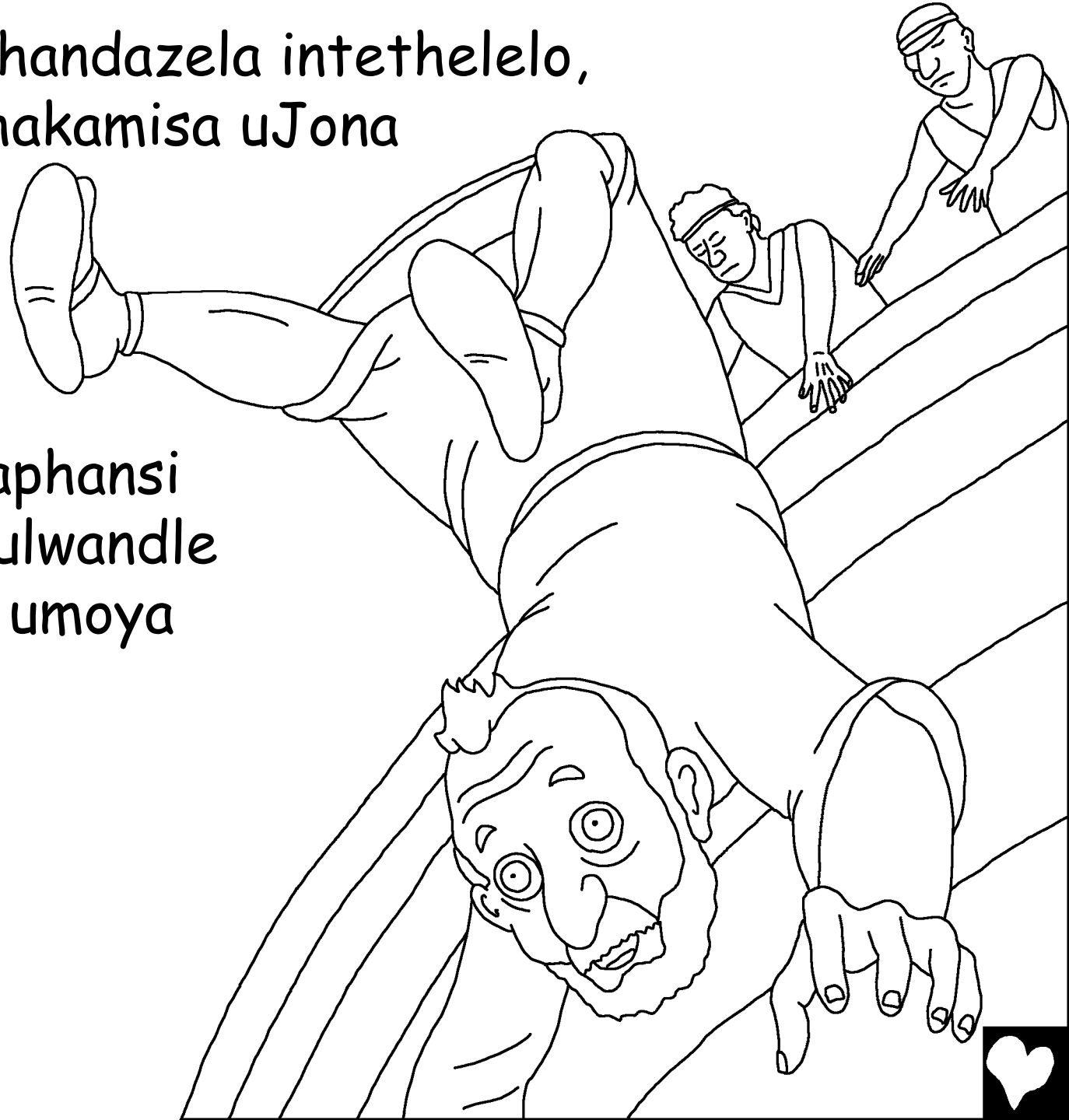

Ukushintsha kwesimo sezulu kungazelelwe
kwathusa amatilosi ngaphezu
kwesiphepho.
Kumele
ukuba babazi
uNkulunkulu
kuphela owayengenza lokho.
Ngokwesaba nangokumangala,
bakhuleka kuJehova.



Phakathi naleso
sikhathi, isithunywa
esingalaleli
samangala kakhulu.
Njengoba ecwila
ekujuleni kolwandle,
uJona wayazi
ukuthi akukho
okwakungamsindisa
ekuminzeni.
Wayeyominza,
futhi - kodwa
uNkulunkulu
wayenamanye
amacebo.

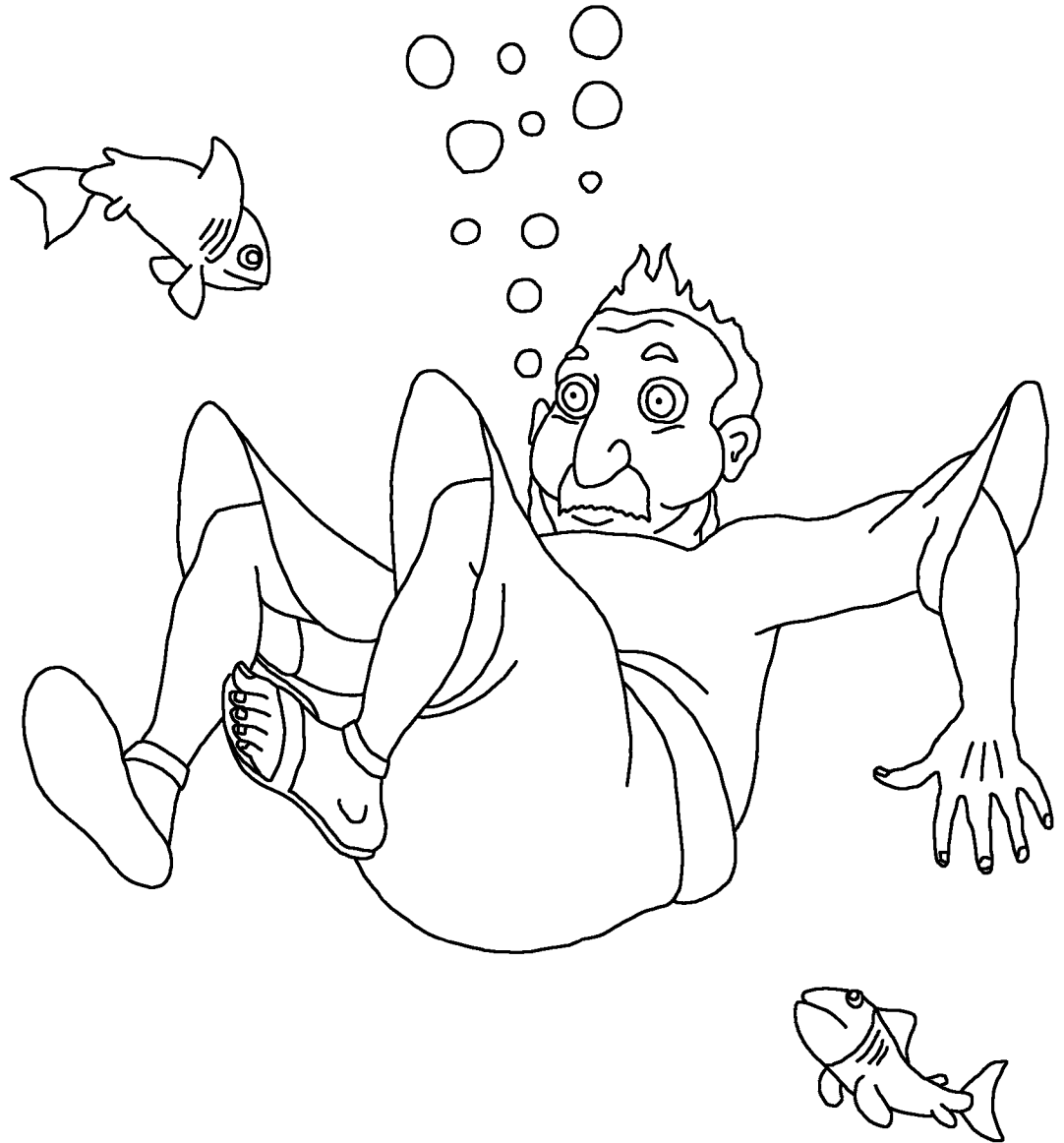

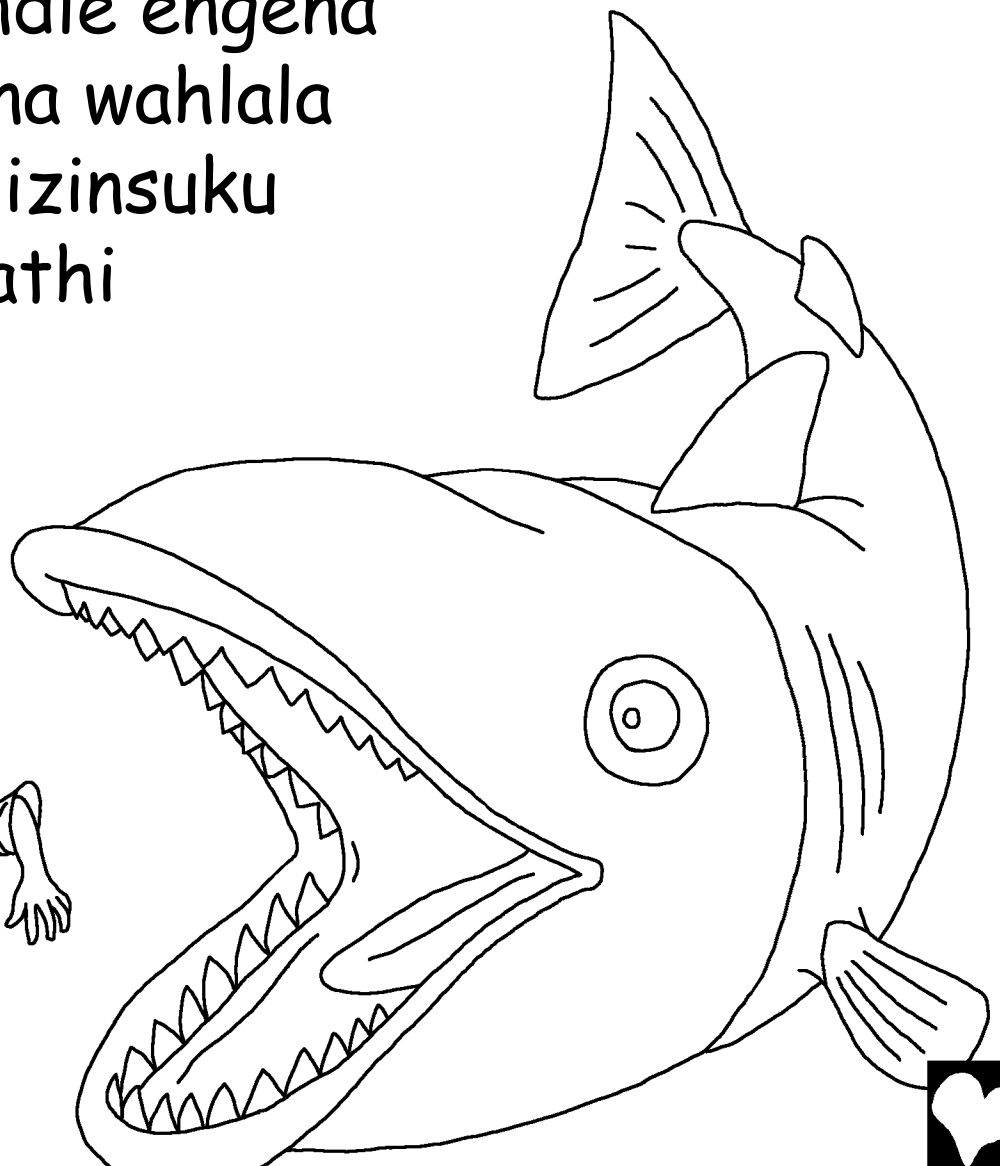
UJehova wayeselungise inhlanzi enkulu ukuba imgwinye uJona. Inhlanzi yafike ngesikhathi! UJona wayephuma elwandle engena esiswini senhlanzi. UJona wahlala ngaphakathi kwenhlanzi izinsuku ezintathu. Wayenesikhathi esiningi sokucabanga nokuthandaza.



Ngemva kwezinsuku ezintathu, uJona wagcina ethembise ukulalela uNkulunkulu. Ngokushesha, uNkulunkulu wakhuluma nenhlanzi, futhi yamhlanzela uJona ogwini.

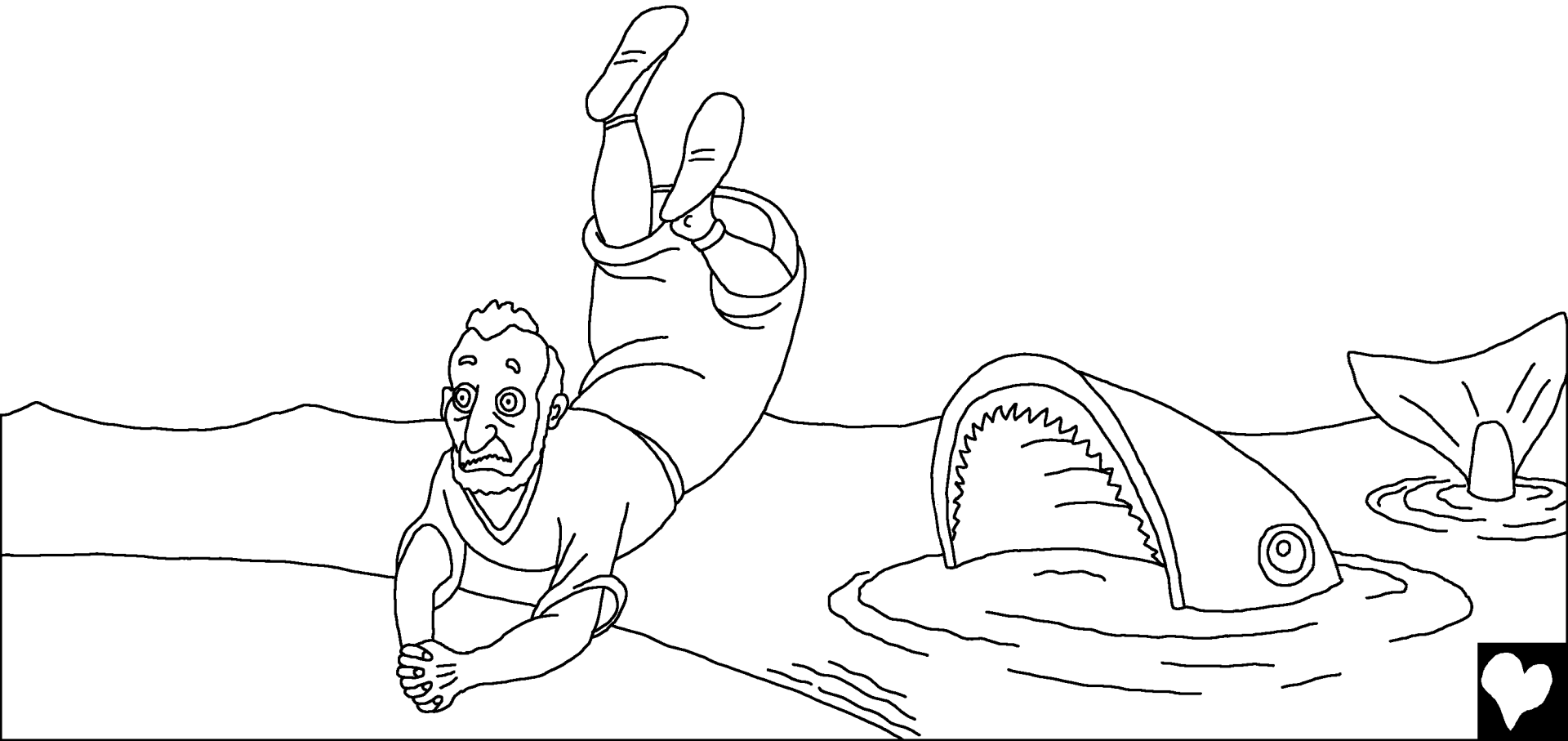

Nakulokhu, uNkulunkulu watshela uJona ukuthi aye eNineve futhi ayoshumayela izwi likaNkulunkulu. Kulokhu, uJona wahamba! UJona wangena emzini, wamemeza wathi: "Ezinsukwini ezingamashumi amane iNineve liyakuchithwa."



Abantu baseNineve balikholwa izwi likaNkulunkulu.
Bahamba bengadlile, bembatha indwangu yamasaka
ukuze babonise uNkulunkulu ukuthi bayazisola
ngezono zabo. Ngisho nenkosi yazithoba phambi
kukaNkulunkulu. Yasuka esihlalweni sayo
sobukhosi, yembatha indwangu
yamasaka, yahlala emlotheni.

Yayala bonke abantu
ukuba baphenduke
ezindleleni zabo ezimbi
nasebudloveni, futhi

bathandazele
ukuba uJehova
abathethelele.

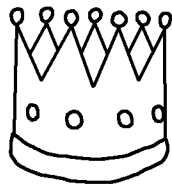

UNkulunkulu WABA thethelela! Kumelwe ukuba kwakuwusuku oluhle kakhulu lwenjabulo eNineve lapho abantu begaphela ukuthi uNkulunkulu wayebathethelele. ...

Kodwa umuntu oyedwa wayethukuthele kakhulu. UJona!



Kungani uJona wathukuthela? Wathi kuNkulunkulu,
"Bengazi ukuthi unguNkulunkulu onomusa, nesihe,
owephuza ukuthukuthela, unomusa omkhulu."
Ngamanye amazwi, uJona wayazi ukuthi uNkulunkulu

uyabathethelela njalo labo
abazisola ngezono zabo futhi
balalele iZwi likaNkulunkulu.
Kubonakala sengathi uJona
wayengabathandi abantu
baseNineve. Wayengafuni
bathethelelwe.



UJona wamthukuthelela uNkulunkulu kangangokuthi wathi, "Susa ukuphila kwami kimi; ngoba ukufa kungcono kimi kunokuphila."



UJona wahlala ngaphandle komuzi, elindele ukubona ukuthi uNkulunkulu wayezokwenzani ngokulandelayo. INkosi uNkulunkulu yalungisa isitshalo esinamaqabunga amakhulu. Yakhula masinyane, futhi yasibekela uJona elangeni elishisayo usuku lonke.



Ngakusasa ekuseni, uNkulunkulu wathumela isibungu,
esabulala lesi sitshalo. UJehova wavusa umoya
oshisayo, onamandla, owavunguza uJona waze
wacabanga ukuthi uzokufa. Konke lokhu
kwamthukuthelisa nakakhulu uJona.



UJehova wayesethi kuJona: "Ingabe unalo ilungelo lokuthukuthela na? Wawuhawukela umvini, ongawusebenzanga, ongawukhulisanga.

Kwafika ebusuku futhi kwafa ngobusuku obubodwa.

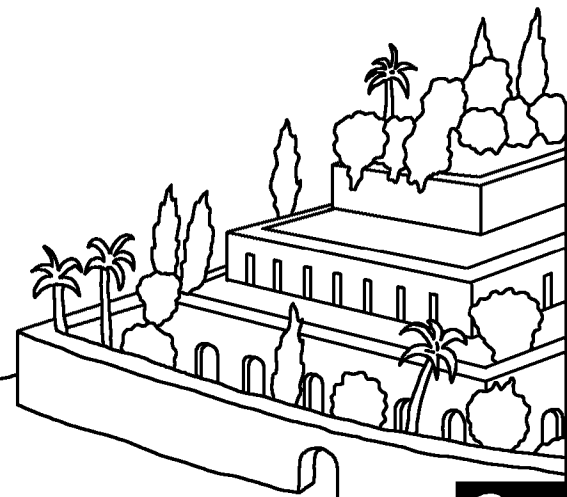
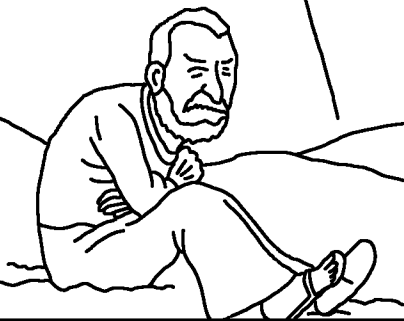

Kungani ngingafanele ngihawukele
iNineve, umuzi omkhulu,
nezinkulungwane zabantu?"



UJona neNhlanzi Enkulu

Indaba evela kwiZwi laNkulunkulu, iBhayibheli,

Itholakala

UJona

“Ukwambulwa kwaMazwi Akho kuyakhanyisa.”
AmaHubo 119:130



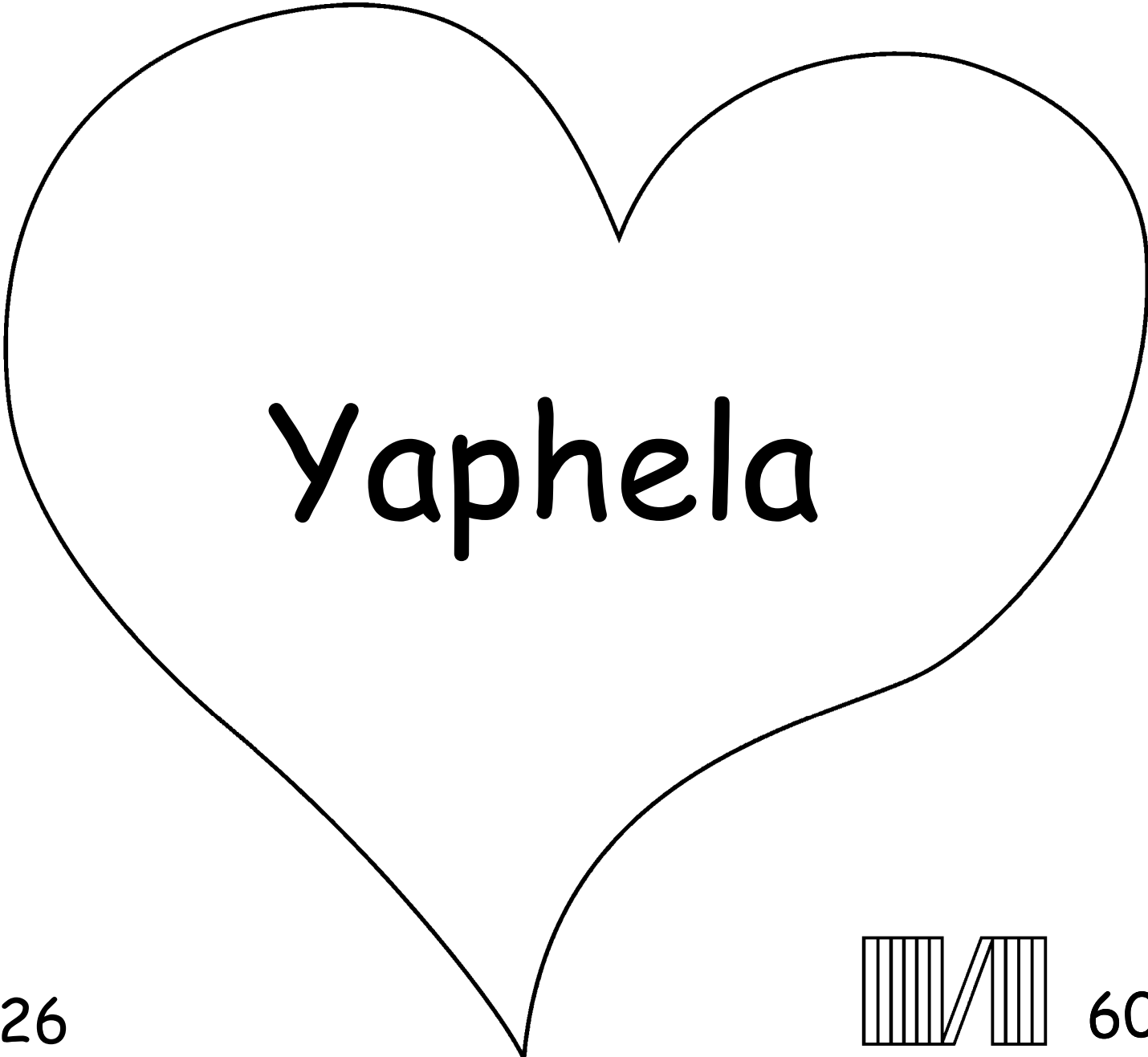

Yaphela



26



60



Lendaba yeBhayibheli isitshela ngoNkulunkulu wethu uyisimanga owasidala futhi ofuna ukuthi wena wazane Naye.

UNkulunkulu uyazi ukuthi senze izinto ezimbi, Azibiza ngesono. Isigwebo sesono ukufa, ngokuba uNkulunkulu walithanda izwe kangaka, waze wanikela ngeNdodana Yakhe ezelwe yodwa ukuba izosifela esiphambanweni igwetshelwe izono zethu. UJesu wase evuka ekufeni wanyukela ezulwini ekhaya lakhe! Uma ukholwelwa kuJesu futhi uma Umcela ukuthi akuthethelele izono zakho, Uzokwenza lokho! Uzoza ezophile ngaphakathi kwakho manje, futhi uzophila Naye kuze kube ingunaphakade.

Uma ukholwa ukuthi iqiniso leli, ithi kuNkulunkulu:
Nkosi Jesu, Ngiyakholwa ukuthi wena unguNkulunkulu, futhi wehla ezulwini waba inyama ukuze ufele izono zami, wavuka ekufeni usuyaphila futhi. Ngicela ungene empilweni yami ungithethelele izono zami, ukuze ngizokwazi ukuba nempilo entsha, ukuze ngiyokwazi ukuba Nawe kuze kube phakade. Ngisize ukuba ngilalele Wena futhi ngiphilele Wena njengomntwana Wakho. Ameni.

Funda iBhayibheli futhi khuluma noNkulunkulu nsuku zonke! Johane 3:16

